

TOOLCRAFT®



CATALOG 2021



WIN - WIN

We offer our clients the best Business Plan, attractive profitability with our Benefits Program, always considering the development of their business based on a win-win relationship.

Our trade policies are clear to all our clients, thus offering confidence and ease of implementation, ensuring that they guarantee the profitability, displacement and good performance of our clients' business.

Consult your advisor, who will guide you towards the best use of the program and our trade policies.

CHECK OUT OUR SOCIAL NETWORKS



ToolcraftMx



@toolcraftMx



Toolcraft TV

OUR BRANDS

They are the result of several years of effort, and thanks to the preference of our customers, distributors and vendors, together with the quality of our products, consumers prefer these brands.



Everything for the lighting market and electrical installation, strictly complying with the national standards.



All the protection in locksmith for home and business, always looking for maximum security and confidence.

WE ARE A GLOBAL COMPANY

We are present in more than 20 countries in Central America, South America and the Caribbean, supplying through four distribution centers.



Tools for the professional market, which are characterized by their high quality in product and packaging, and by looking for the consumer to work better, smarter and faster.



The solution for plumbing installations in bathrooms and kitchens.



For basic needs, having a balance between quality and fair price, very competitive.



Distribution Centers

Mexico

Guatemala

Colombia

Peru

WEB PAGE

As of this catalog edition, we inform you about the renewal of our website. In it you can find the update of our brands, the introduction of new products, customer service, as well as the option of inquire our catalog of products.

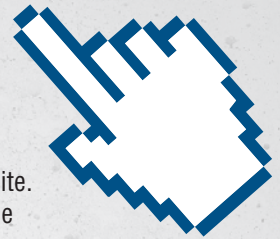

toolcraft.mx



NETWORK OF CSA SERVICE CENTERS.

We have expanded our network of service centers, which grows every year, providing reassurance to our customers. We offer maintenance service for the entire line of power products marketed by the Toolcraft group.

On our website, our final clients can have access to manuals and definitions of parts of each tool, as well as the information of the nearest service center. We also offer direct online contact, in order to answer your questions about service and warranty.



CUSTOMER SERVICE CENTER

Because we want to be closer to you, we have call center that provides personalized advice, support and care to any need of our clients and associates.

We are at your service.

Free call

01800.834.9400

Monterrey

(81)81.96.26.15



STEELS AND DERIVATIVES

AUTOMOTIVE

LOAD

POWER TOOLS

GARDENING

PAINTING

SAFETY

STEELS

STEEL CABLE COVERED WITH PVC

- The 7 X 7 cable is rigid
- The 7 x 19 cable is flexible
- Made of anti-corrosive galvanized steel

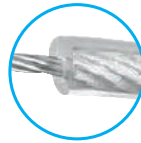
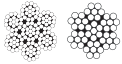

⚠ Never use to lift people or animals.



*Price per roll

Code	Length	Width	Load Capacity	Inner Master	
				7 x 7	7 x 7
TC4060	150 m	1/16" x 1/16"	218 kg	1	1
TC0990	75 m	3/32" x 3/32"	417 kg	1	1
TC0991	75 m	1/8" x 1/8"	777 kg	1	1
TC4061	75 m	3/16" x 3/16"	1,678 kg	1	1
TC4062	150 m	3/32" x 3/32"	453 kg	1	1
TC0992	75 m	1/8" x 1/8"	907 kg	1	1
TC0993	75 m	3/16" x 3/16"	1,905 kg	1	1

Type of packaging: Box

STEEL CABLE

- The 7 X 7 cable is rigid
- The 7 x 19 cable is flexible
- Made of anti-corrosive galvanized steel

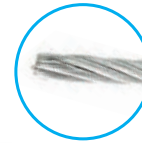
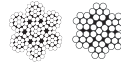

✓ IMPROVED PRODUCT



⚠ Never use to lift people or animals.



*Price per roll

Code	Length	Width	Load capacity	Thimble	Inner Master	
					7 x 7	7 x 7
TC5443	150 m	1/16"	218 kg	Included	1	1
TC5444	450 m	1/16"	218 kg	Included	1	1
TC5445	150 m	3/32"	417 kg	Included	1	1
TC5446	150 m	1/8"	777 kg	Included	1	1
TC5447	450 m	1/8"	777 kg	Included	1	1
TC0988	75 m	3/16"	1,905 kg	Not included	1	1
TC0989	75 m	1/4"	3,175 kg	Not included	1	1

Type of packaging: Box

GALVANIZED CHAIN

- Made of high carbon tempered steel
- Chain grade 30
- Electrowelded links



Bucket 25 Kg
*Price per bucket

Code	Measure	Maximum load	Approx. length	Inner	Master
TC1103	1/8"	180 kg	115 m	1	1
TC1104	5/32"	300 kg	86 m	1	1
TC1105	3/16"	210 kg	60 m	1	1
*TC1108	1/4"	420 kg	32 m	1	1
TC1109	5/16"	850 kg	18 m	1	1
TC1106	3/8"	1200 kg	12 m	1	1
TC1107	1/2"	2030 kg	6 m	1	1

Type of packaging: Bucket

POLISHED CHAIN

- Made of high carbon tempered steel
- Chain grade 30
- Electrowelded links



Bucket 25 Kg
*Price per bucket

Code	Measure	Maximum load	Approx. length	Inner	Master
TC0899	1/8"	180 kg	115 m	1	1
TC0900	5/32"	300 kg	86 m	1	1
TC0901	3/16"	210 kg	60 m	1	1
*TC0905	1/4"	420 kg	32 m	1	1
TC0902	5/16"	850 kg	18 m	1	1
TC0903	3/8"	1200 kg	12 m	1	1
TC0904	1/2"	2030 kg	6 m	1	1

Type of packaging: Bucket

CHAIN

- Made of galvanized steel



*Price per roll

Code	Diameter	Length	Maximum load	Inner Master	
				Reel	Reel
TC1083	mm	30 m	40 kg	1	4
TC1084	2.5 mm	30 m	70 kg	1	4
TC1085	3.0 mm	30 m	120 kg	1	4
TC1086	3.5 mm	30 m	140 kg	1	2
TC1087	4.0 mm	30 m	160 kg	1	2
TC1088	2.0 mm	250 m	40 kg	1	1
TC1089	2.5 mm	192 m	70 kg	1	1
TC1090	3.0 mm	122 m	120 kg	1	1
TC1091	3.5 mm	100 m	140 kg	1	1
TC1092	4.0 mm	64.9 m	160 kg	1	1

Type of packaging: Reel, Bucket

WING NUT

- Steel body
- Standard screw



*Price per piece

Code	Measure	Inner	Master
TC0911	1/8"	200	7200
TC0912	5/32"	200	7200
TC0913	3/16"	200	7200
TC0914	1/4"	100	3600
TC0915	5/16"	60	2160
TC0916	3/8"	30	1080
TC0917	1/2"	20	720

Type of packaging: Bulk

BLACK NAIL FOR CONCRETE

- Striated body for greater holding power.



Packed in bags of 1 kg



*Price per bag 1 Kg

Code	Measure	Gauge	Nails approx. per kg	Inner	Master
TC5504	1"	8	335	1	1
TC5505	1"	8	232	1	1
TC5506	2"	8	177	1	1
TC5507	2"	8	143	1	1
TC5508	3"	8	120	1	1

Type of packaging: Box

SCREW FOR METAL ROUNDED HEAD

- Cross input
- Standard cord
- Galvanized finishing



Box
100 pieces
*Price per box

Code	Length	Inner	Master
Gauge 8			
TC2884	1/2"	10	102
TC2885	5/8"	10	102
TC2886	3/4"	10	102
TC2887	1"	10	48
TC2888	1"	10	48
TC2889	1"	10	48
TC2890	2"	10	24
Gauge 10			
TC2892	1/2"	10	102
TC2893	5/8"	10	48
TC2894	3/4"	10	48
TC2895	1"	10	48
TC2896	1"	10	48
TC2897	1"	10	24
TC2898	2"	10	24

Type of packaging: Box

GALVANIZED NAIL FOR CONCRETE

- Striated body for greater holding power.



Packed in bags of 1 kg



*Price per bag 1 Kg

Code	Measure	Gauge	Nails approx. per kg	Inner	Master
TC5499	1"	8	335	1	1
TC5500	1"	8	232	1	1
TC5501	2"	8	177	1	1
TC5502	2"	8	143	1	1
TC5503	3"	8	120	1	1

Type of packaging: Box

LOST HEAD STANDARD NAIL

- Striated body for greater holding power.
- Bulk packing



Box
25 Kg
*Price per box

Code	Measure	Gauge	Nails approx. per kg	Inner	Master
TC3527	1"	16	2,341	1	1
TC3528	1"	14.5	1,114	1	1
TC3529	2"	13	514	1	1
TC3530	2"	13	325	1	1

Type of packaging: Box

SCREWS FOR WOOD CONICAL HEAD

- Cross input
- Standard cord
- Galvanized finishing



Box
100 pieces
*Price per box

Code	Length	Inner	Master
Gauge 8			
TC2907	1/2"	10	125
TC2908	3/4"	10	125
TC2909	1"	10	100
TC2910	1"	10	75
TC2911	1"	10	60
TC2912	2"	10	48
Gauge 10			
TC2915	3/4"	10	100
TC2916	1"	10	60
TC2917	1"	10	48
TC2918	1"	10	48
TC2919	2"	10	40

Type of packaging: Box

STANDARD FLAT HEAD NAIL

- Striated body for greater holding power.
- Bulk packing



Box
25 Kg
*Price per box

Code	Measure	Gauge	Nails approx. per kg	Inner	Master
TC2498	2"	12.5	460	1	1
TC2499	2"	11	260	1	1
TC2500	3"	10.5	190	1	1
TC2501	3"	8	105	1	1
TC2502	4"	7	77	1	1

Type of packaging: Box

CLOSED PLASTIC PACKAGES

- It has arms that ensure the anchorage
- Thick spikes
- Base without brow



Bag
100 pieces
*Price per bag

Code	Measure	Inner	Master
TC2872	1/4"	20	100
TC2873	5/16"	20	100
TC2874	3/8"	20	100

Type of packaging: Bag

SCREW FOR DRY WALL CONICAL HEAD

- Cross input
- Open rope for wood
- Bluing
- Multipurpose



*Price per box

Code	Length	Pieces / Box	Inner	Master
Gauge 6				
TC2931	1"	1,000	5	12
TC2932	1"	1,000	5	12
TC2933	1"	1,000	5	8
TC2934	1"	1,000	5	8
TC2935	1"	500	5	12
TC2936	2"	500	5	12
Gauge 8				
TC2937	1"	1,000	5	12
TC2938	1"	1,000	5	8
TC2939	1"	500	5	12
TC2940	1"	500	5	12
TC2941	2"	500	5	8

Type of packaging: Box

NAIL

- Grooved body for greater resistance
- For installation of asphalt shingle and insulation panels



Packaged in a 1 kg box to facilitate its commercialization

Code	Measure	Gauge	Nails approx. per Kg	Inner	Master
TC2035	1" x 3.5 mm	10.5	457	1	1
TC2036	1 1/4" x 3.5 mm	10.5	383	1	1

Type of packaging: Box

ENDLESS CLAMP, 1/2" (12.5 MM) STRAP

- Strap and frame of stainless steel



Bag
10 pieces
TC4691 - TC4693
TC4678 - TC4683

Bag
5 pieces
TC4684 - TC4690

*Price per bag

Code	#	Minimum opening.	Maximum opening.	Inner	Master
TC4691	#4	3/8" (10 mm)	5/8" (16 mm)	10	100
TC4692	#6	1/2" (11 mm)	3/4" (20 mm)	10	100
TC4693	#8	1/2" (12 mm)	7/8" (23 mm)	10	100
TC4678	#10	5/8" (16 mm)	1" (25 mm)	10	100
TC4679	#12	9/16" (14 mm)	1 1/4" (32 mm)	10	100
TC4680	#16	5/8" (17 mm)	1 1/2" (38 mm)	10	100
TC4681	#20	3/4" (19 mm)	1 3/4" (44 mm)	10	100
TC4682	#24	1" (27 mm)	2" (51 mm)	10	50
TC4683	#28	1 1/4" (33 mm)	2 1/4" (57 mm)	5	50
TC4684	#32	1 1/2" (40 mm)	2 1/2" (63 mm)	5	50
TC4685	#36	1 3/4" (46 mm)	2 3/4" (70 mm)	5	50
TC4686	#40	2" (52 mm)	3" (76 mm)	5	50
TC4687	#44	2 1/4" (59 mm)	3 1/4" (83 mm)	5	50
TC4688	#52	2 3/4" (71 mm)	3 3/4" (95 mm)	5	50
TC4689	#60	3 1/4" (84 mm)	4 1/4" (108 mm)	5	50
TC4690	#72	3" (76 mm)	5" (127 mm)	5	50

Type of packaging: Bag

MINI ENDLESS CLAMP, 5/16" (8 MM) STRAP

- Stainless steel band and frame



Bag
10 pieces
*Price per bag

Code	#	Minimum opening	Maximum opening	Inner	Master
TC4675	#4	1/4" (6 mm)	5/8" (16 mm)	10	200
TC4676	#6	1/2" (11 mm)	3/4" (20 mm)	10	200
TC4677	#8	1/2" (12 mm)	7/8" (23 mm)	10	200

Type of packaging: Bag

STEEL SPRING SNAP LINK

- Spring latch
- Quick attachment
- Light duty



Code	Thickness	Length	Inner	Master
TC2544	7 mm	70 mm	12	72
TC2545	8 mm	80 mm	12	72
2-piece set				
TC2542	5 mm	50 mm	12	72
TC2543	6 mm	60 mm	12	72

Type of packaging: Bag

ALUMINUM SNAP LINK

- Spring latch
- Quick attachment
- Light duty



Code	Thickness	Length	Inner	Master
TC2549	7 mm	70 mm	12	72
TC2550	8 mm	80 mm	12	72
2-piece set				
TC2547	5 mm	50 mm	12	72
TC2548	6 mm	60 mm	12	72

Type of packaging: Bag

STEEL QUICK LINK

- With lock
- Galvanized carbon steel body
- Repairs broken chains
- Heavy duty



Code	Diameter of axis	Maximum load	Inner	Master
TC2605	5/16"	700 kg	12	72
TC2606	3/8"	1,000 kg	12	72
TC2607	1/2"	1,360 kg	12	72
2-piece set				
TC2602	1/8"	100 kg	12	72
TC2603	3/16"	300 kg	12	72
TC2604	1/4"	400 kg	12	72

Type of packaging: Bag

STEEL SPRING SNAP LINK

- Ideal for quick attachment
- Galvanized carbon steel body
- Medium duty



Code	Diameter of axis	Maximum load	Inner	Master
TC2610	5/16"	115 kg	12	72
TC2611	3/8"	180 kg	12	72
TC2612	1/2"	270 kg	12	72
2-piece set				
TC2608	3/16"	50 kg	12	72
TC2609	1/4"	65 kg	12	72

Type of packaging: Bag

SWIVEL HALTER BOLT SNAP

- Metal body
- Light duty



Code	Length	Maximum load	Inner	Master
TC2552	2"	15 kg	12	72
TC2553	3"	20 kg	12	72
TC2554	3 1/2"	40 kg	12	72
TC2555	4"	40 kg	12	72
TC2556	4 1/4"	40 kg	12	72

Type of packaging: Bag

METAL SWIVEL BOLT SNAP

- Metal body
- Spring latch
- Light duty



Code	Length	Maximum load	Diameter of axis	Inner	Master
TC2557	2"	25 kg	12 mm	12	72
TC2558	3"	35 kg	13 mm	12	72
TC2559	3"	45 kg	14 mm	12	72
TC2560	4"	45 kg	20 mm	12	72
TC2561	4"	75 kg	22 mm	12	72

Type of packaging: Bag

BRASS-PLATED SWIVEL BOLT SNAP

- Spring latch
- With bolt snap
- Light duty

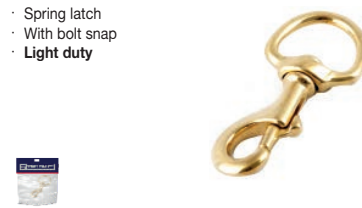

Code	Length	Maximum load	Diameter of axis	Inner	Master
TC2562	3"	95 kg	16 mm	6	72
TC2563	3"	95 kg	19 mm	6	72
TC2564	3"	105 kg	25 mm	6	72
TC2565	4"	135 kg	28 mm	6	72
TC2566	4"	150 kg	32 mm	6	72

Type of packaging: Bag

DOUBLE BRASS-PLATED BOLT SNAP

- Spring latch
- Light duty



Code	Maximum load	Length	Inner	Master
TC2567	75 kg	3"	12	72
TC2568	105 kg	4"	12	72
TC2569	120 kg	4"	12	72

Type of packaging: Bag

METAL DOUBLE END SWIVEL

- Nickel-plated metal body
- Spin chain without tangle
- **Light duty**



Code	Measure	Maximum load	Inner	Master
TC2587	1/8"	25 kg	12	72
TC2588	5/32"	45 kg	12	72
TC2589	3/16"	50 kg	12	72
TC2590	1/4"	50 kg	12	72
TC2591	5/16"	50 kg	12	72

Type of packaging: Bag

METAL DOUBLE END SWIVEL IN GALVANIZED STEEL

- Galvanized steel body
- Spin chain without tangle
- **Heavy duty**



Code	Measure	Maximum load	Inner	Master
TC2593	1/4"	385 kg	4	72
TC2594	5/16"	565 kg	4	72
TC2595	3/8"	1010 kg	4	72
TC2596	1/2"	1630 kg	4	36

Type of packaging: Bag

SWIVEL EYE PULLEY

- Steel sheet body
- **Light duty**



Code	Diameter	Maximum load	Inner	Master
TC2582	3/4"	40 kg	25	72
TC2583	1"	50 kg	6	72
TC2584	1 1/2"	75 kg	10	72
TC2585	2"	90 kg	1	72

Type of packaging: Bag

SHACKLE

- Forging and hardened
- Galvanized by immersion
- With locking post
- **Heavy duty**



Code	Measure	Maximum load	Inner	Master
TC3312	3/16"	300 kg	12	960
TC3313	1/4"	450 kg	12	360
TC3314	5/16"	680 kg	12	240
TC3315	3/8"	910 kg	12	120
TC3316	7/16"	1,360 kg	12	120
TC3317	1/2"	1,810 kg	12	48
TC3318	5/8"	2,950 kg	4	32
TC3319	3/4"	4,310 kg	4	16
TC3320	7/8"	6,400 kg	4	8
TC3321	1"	8,300 kg	3	8
TC3322	1"	9,400 kg	1	6
TC3323	1"	12,000 kg	1	4
TC3324	1"	13,450 kg	1	4
TC3325	1"	16,900 kg	1	2

Type of packaging: Bulk

STEEL WIRE ROPE THIMBLE

- Steel sheet body
- **Light duty**



*Price per bag

Code	Content	Measure	Inner	Master
TC2613	10 pieces	1/8"	12	72
TC2614	10 pieces	3/16"	12	72
TC2615	10 pieces	1/4"	12	72
TC2616	5 pieces	5/16"	12	72
TC2617	5 pieces	3/8"	12	72
TC2618	5 pieces	7/16"	12	72

Type of packaging: Bag

S-HOOK

- Made of galvanized steel
- **Light duty**



Code	Content	Measure	Maximum load	Inner	Master
TC2597	2 pieces	3/16"	13 kg	12	72
TC2598	2 pieces	1/4"	38 kg	12	72
TC2599	1 piece	5/16"	75 kg	12	72

Type of packaging: Bag

WIRE ROPE CLAMP

- 1 piece body made of malleable iron
- Fork and steel nut
- Galvanized for higher weather resistance



EYE SNAP HOOK WITH LOCK

- Made of carbon steel
- Spring latch
- Quick attachment
- **Heavy duty**



Code	Measure	Maximum load	Inner	Master
TC2620	5/8"	1,000 kg	10	160
TC2621	5/8"	1,500 kg	10	160
TC2622	5/8"	2,000 kg	10	160

Type of packaging: Bulk

CLEVIS GRAB HOOK

- Made of galvanized tempered steel
- Grade 30
- Assembly to link with bolt and lock
- **Heavy duty**



Code	Measure	Type	Maximum load	Inner	Master
TC1146	1/4"	Width	1,248 kg	10	100
TC1147	5/16"	Width	1,952 kg	10	80
TC1148	3/8"	Width	2,383 kg	10	50
TC1149	1/4"	Short	1,589 kg	10	100
TC1150	5/16"	Short	2,133 kg	10	80
TC1151	3/8"	Short	3,223 kg	10	50

Type of packaging: Bulk

Code	Thickness	Inner	Master
TC0951	1/8"	50	1000
TC0952	3/16"	50	500
TC0953	1/4"	50	500
TC0954	5/16"	50	250
TC0955	3/8"	25	250
TC0956	7/16"	25	250
TC0957	1/2"	25	100
TC0958	5/8"	25	100
TC0959	3/4"	10	50
TC0960	7/8"	10	50
TC0961	1"	10	20

Type of packaging: Bulk

HOOK-HOOK TURNBUCKLE

- Metal body
- Carbon steel hook and hoop
- **Light duty**



Code	Measure	Maximum load	Inner	Master
TC2577	3/16"	41 kg	12	72
TC2578	1/4"	50 kg	12	72
TC2579	5/16"	100 kg	12	72
TC2580	3/8"	204 kg	12	72

Type of packaging: Bulk

**FORGED STEEL
HOOK-HOOP TURNBUCKLE**

- Made of forged steel
- Galvanized coated
- Heavy duty



Code	Measure	Maximum load	Inner	Master
TC2624	1/2" x 1/2"	680 kg	4	6
TC2625	5/8" x 5/8"	1,000 kg	2	6
TC2626	3/4" x 3/4"	1,300 kg	2	6
TC2627	7/8" x 7/8"	1,800 kg	1	4
TC2628	1" x 1"	2,250 kg	1	4

Type of packaging: Bulk

HOOK-HOOP TURNBUCKLE

- Metal body
- Carbon steel hook and hoop
- Light duty



Code	Measure	Maximum load	Inner	Master
TC2572	3/16"	41 kg	12	72
TC2573	1/4"	50 kg	12	72
TC2575	3/8"	204 kg	12	72

Type of packaging: Bulk

LOAD BINDER

- Made of steel
- Ball and socket swivel joint sat hock assemblies



Code	Measure	Maximum load	Inner	Master
TC3340	5/16" - 3/8"	2,450 kg	1	5
TC3341	3/8" - 1/2"	4,175 kg	1	4
TC3342	1/2" - 5/8"	4,990 kg	1	2

Type of packaging: Bulk

REINFORCED GALVANIZED MESH

- Heavy gauge for heavy duty
- 91 cm wide

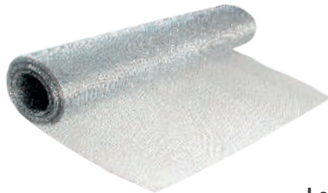

Length
30 m
*Price per roll

Code	Opening	Inner	Master
TC2451	2 x 2 mm	1	1
TC2452	3 x 3 mm	1	1
TC2453	4 x 4 mm	1	1
TC2454	5 x 5 mm	1	1
TC2455	6 x 6 mm	1	1
TC2640	8 x 8 mm	1	1

Type of packaging: Roll

GALVANIZED MESH

- 91 cm wide

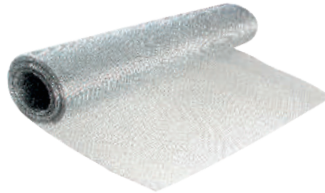

Length
10 m
*Price per roll

Code	Opening	Inner	Master
TC2456	2 x 2 mm	1	1
TC2457	3 x 3 mm	1	1
TC2458	4 x 4 mm	1	1
TC2459	5 x 5 mm	1	1
TC2460	6 x 6 mm	1	1
TC2641	8 x 8 mm	1	1

Type of packaging: Roll

11-GAUGE CHAIN LINK WIRE MESH

- Made of galvanized steel
- Corrosion resistant
- Twisted tips
- 55mm x 55mm opening

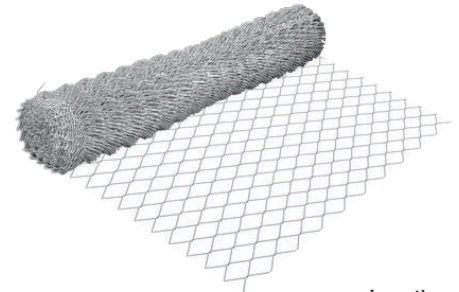

Length
20 m
*Price per roll

Code	Height	Inner	Master
TC2468	1.50 m	1	1
TC2470	2.00 m	1	1

Type of packaging: Roll

12.5-GAUGE CHAIN LINK WIRE MESH

- Made of galvanized steel
- Corrosion resistant
- Twisted tips
- 55mm x 55mm opening

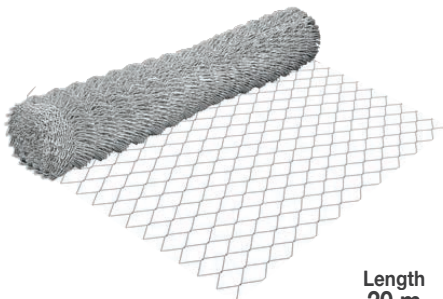

Length
20 m
*Price per roll

Code	Height	Inner	Master
TC2473	1.50 m	1	1
TC2475	2.00 m	1	1

Type of packaging: Roll

12.5-GAUGE CHAIN LINK WIRE MESH

- Made of galvanized steel
- Corrosion resistant
- Twisted tips
- 63mm x 63mm opening

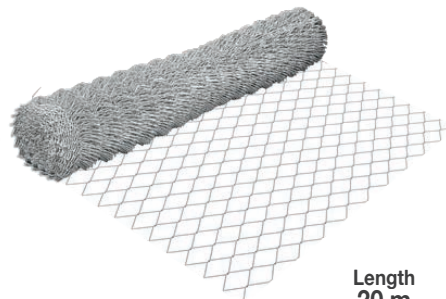

Length
20 m
*Price per roll

Code	Height	Inner	Master
TC2478	1.50 m	1	1
TC2480	2.00 m	1	1

Type of packaging: Roll

13-GAUGE CHAIN LINK WIRE MESH

- Made of galvanized steel
- Corrosion resistant
- Twisted tips
- 69mm x 69mm opening

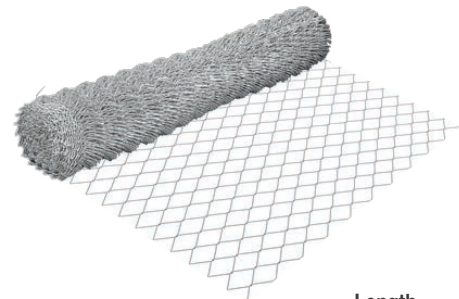

Length
20 m
*Price per roll

Code	Height	Inner	Master
TC2483	1.50 m	1	1
TC2485	2.00 m	1	1

Type of packaging: Roll

HEXAGONAL WIRE MESH

- Made of galvanized steel
- Corrosion resistant

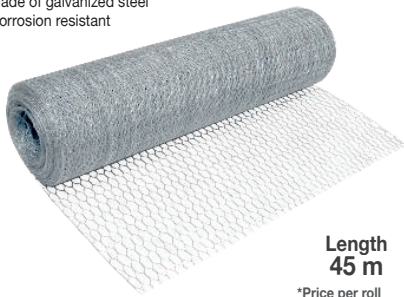

Length
45 m
*Price per roll

Code	Height	Opening	Gauge	Inner	Master
TC1860	0.90 m	13 mm	23	1	1
TC1861	1.00 m	25 mm	22	1	1
TC1862	1.20 m	25 mm	22	1	1
TC1863	1.50 m	25 mm	22	1	1
TC1864	1.75 m	25 mm	22	1	1
TC1865	1.50 m	38 mm	22	1	1
TC1866	1.75 m	38 mm	22	1	1
TC1867	1.50 m	50 mm	22	1	1
TC1869	1.75 m	50 mm	20	1	1

Type of packaging: Roll

14-GAUGE MULTI WIRE MESH

- Made of galvanized steel
- Corrosion resistant
- For the fabrication of medium-sized animal cages
- 1.22 m wide

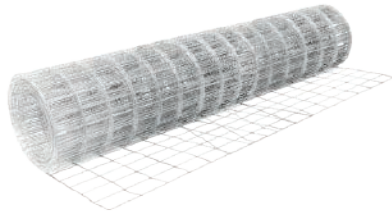

Length
20 m
*Price per roll

Code	Opening	Inner	Master
TC2486	5 cm x 5 cm	1	1
TC2487	5 cm x 5 cm	1	1

Type of packaging: Roll

26 GAUGE FALSE CEILING MESH

- Made of steel sheet
- Corrosion resistant
- Model: 500
- Used to make construction work easier.
- 0.91 m wide

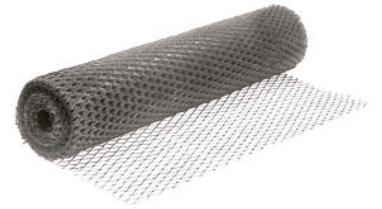

Length
22 m
*Price per roll

Code	Height	Length	Inner	Master
TC2488	0.91 m	22 m	1	1

Type of packaging: Roll

MONTANA BARBED WIRE

- Wire gauge 12.5
- Barb gauge 14.5
- Approx. weight per meter 92.3 g
- Double twist
- Pre tightened roll for easy installation

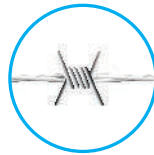

*Price per roll

Code	Weight	Approx. length	Inner	Master
TC2495	30 kg	m	1	1

Type of packaging: Roll

TEXAS BARBED WIRE

- Wire gauge 15.5
- Barb gauge 16.5
- Approx. weight per meter 46.6 g
- Single twist
- Pre tightened roll for easy installation



*Price per roll

Code	Weight	Approx. length	Inner	Master
TC2497	13.97 kg	300 m	1	1

Type of packaging: Roll

CONCERTINA MAXIMUM SECURITY, 8M

- Made of steel
- Galvanized finishing
- 33 spirals



Long 8-point jackknife with hook effect

- Blade spacing: 100 mm (1)
- Length of blades: 60 mm (2)
- Diameter of wire: 2.5 mm (3)

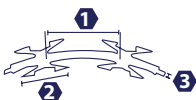

*Price per roll

Code	Installation coverage	Weight	Inner	Master
TC5267	8 m	5.1 kg	1	1

Type of packaging: Box

GALVANIZED WIRE

- For ties, repairs, etc.
- Each master box contains 20 rolls of 1 kg



Roll
1 Kg
*Price per roll

Code	Gauge	Diameter	Approx. length	Inner	Master
TC5509	12.5	2.44 mm	27 m	1	1
TC5510	14.5	1.85 mm	46 m	1	1
TC5511	16	1.57 mm	61 m	1	1
TC5512	18	1.22 mm	119 m	1	1
TC5513	20	0.84 mm	279 m	1	1
TC5514	22	0.71 mm	340 m	1	1

Type of packaging: Bulk

MULTI PURPOSE LITHIUM GREASE

- Protects premature wear, corrosion and oxidation
- Great resistance to washing with water

SPECIFICATIONS

- Grade NLGI2
- Penetration to 60 @ 25 °C
- Strikes (1/10 mm): 265 to 295
- Drip point: 180 °C



Code	Content	Inner	Master
TC5404	450 g	6	12

Type of packaging: Can

CARBURETTOR CLEANER

- Cleans the interior and exterior of carburetors without disassembling
- For 2 and 4 stroke engines
- Cleans and removes grease, oil, dust and dirt
- Does not damage the oxygen sensor or the catalytic converter
- It has an applicator for places of difficult access.



Code	Content	Inner	Master
TC5406	470 ml (16 oz)	1	12

Type of packaging: Tin

GREASE FOR 2-STROKE ENGINE

- Viscosity index greater than 140, ISO 68 degree
- Extends the life of the engine up to 80%
- For use on motorcycles, chainsaws, trimmers and hedge trimmers, among others.



Proportion: Mix 20 ml of grease for every liter of gas

Code	Content	Inner	Master
TC5407	118 ml (4 oz)	6	24

Type of packaging: Can

NOZZLE FOR GREASE INJECTOR

- Standard spare parts for conventional grease fitting
- Compatible with models: TC1615, TC1298 y TC1299
- Made of stainless steel
- Ball check valve to prevent the return of grease



Code	Specification	Inner	Master
TC1981	Standard screw	10	400

Type of packaging: Blister

BEARING GREASE

- Lubricates and prevents corrosion
- Made of basic high viscosity grease and stearic calcium soap.
- Good performance under temperatures up to 180°C.
- Do not use on mechanisms containing water



Code	Presentation	Inner	Master
TC2631	Can 400 g	12	12
TC2632	Cartridge 400 g	6	12

Type of packaging: Can (TC2631), Cartridge (TC2632)

CHASSIS GREASE

- Lubricates and prevents corrosion
- Made of basic high viscosity grease and stearic calcium soap.
- Good performance under temperatures up to 130°C.
- Water repellent and has mechanical stability



Code	Presentation	Inner	Master
TC2629	Can 400 g	12	12
TC2630	Cartridge 400 g	6	12

Type of packaging: Can (TC2629), Cartridge (TC2630)

OIL CAN FLEXIBLE TUBE

- Brass nozzle
- Internal metallic mechanism
- Stainless steel rack



Code	Capacity	Inner	Master
TC1440	180 ml (6 oz)	10	50
TC1441	300 ml (10 oz)	10	50
TC1442	500 ml (16 oz)	10	50

Type of packaging: Bulk

FLEXIBLE HOSE FOR GREASE INJECTOR

- Standard spare parts for conventional grease fitting
- Compatible with models: TC1615, TC1298 y TC1299
- Nylon hose
- Maximum pressure capacity: 10,000 PSI



Code	Measure	Inner	Master
TC1423	12"	4	200
TC1424	18"	5	200

Type of packaging: Bulk

GREASE GUN HEAVY DUTY

- Steel body
- Extension and coupler of stainless steel
- Capacity of 500 cc (16.9 oz)
- Rigid nozzle
- Three grease loading methods: bulk, cartridge and dispatcher.
- 5,000 lb/pulg²
- Aluminum head



Code	Capacity	Inner	Master
TC1615	500 cc	2	16

Type of packaging: Box

GREASE GUN

- Steel body
- Extension and coupler of stainless steel
- Capacity of 500 cc (16.9 oz)
- Rigid and flexible nozzle
- Three grease loading methods: bulk, cartridge and dispatcher.
- 5,000 lb/pulg²



Code	Capacity	Inner	Master
TC1298	500 cc	2	16

Type of packaging: Box

MINI GREASE GUN WITH ACCESSORIES

- Steel body
- Extension and coupler of stainless steel
- Capacity of 120 cc (4 oz)
- Uses standard cartridges of 85 g
- Three grease loading methods: bulk, cartridge and dispatcher.
- 3,000 lb/pulg²



Accessories:
 5 1/2" rigid extension with coupler of 1 1/2"
 Flexible 7" extension with 1 1/2" coupler
 4" rigid extension with connector



Code	Capacity	Inner	Master
TC1299	120 cc	2	20

Type of packaging: Blister

GREASE INJECTION PUMP

- Output pressure: 4000 PSI
- Flow: 8 g x pump
- Hose length: 2 m
- Hose diameter: 1/4"
- Sealing plate to prevent air leaks
- Pump and lid assembled in 1 single piece to easy filling.



Code	Capacity	Inner	Master
TC4367	10 kg	1	1

Type of packaging: Box

GREASE INJECTION PUMP

- Output pressure: 4000 PSI
- Flow: 8 g x pump
- Hose length: 2 m
- Hose diameter: 1/4"
- Sealing plate to prevent air leaks
- Pump and lid assembled in 1 single piece to easy filling.



Code	Capacity	Inner	Master
TC4366	6 kg	1	1

Type of packaging: Box

CLOCK TYPE PUMP

- Contains an adapter of 3/4"(19mm)
- Has a lock inside the suction tube
- To use with gasoline, oil, kerosene, diesel, etc.



Flow capacity	0.3 L / Pumping
Tube length	100 cm
Diameter of the tube	1"
Weight	3.25 kg



⚠ Do not use with acids

Code	Type	Inner	Master
TC1061	Clock	2	5

Type of packaging: Box

LEVER PUMP

- Galvanized steel propeller
- Equipped with a telescopic suction tube
- Tip with thread to adjust hoses with connection
- Ideal for lubricants and oils



Flow capacity	0.3 L / Pumping
Tube length	87 cm
Diameter of the tube	1"
Weight	1.92 kg



⚠ Do not use with acids

Code	Type	Inner	Master
TC1080	Handle	2	10

Type of packaging: Box

ALUMINUM HACKSAW FRAME

- High-tension hacksaw frame for 2 positions of blade 90° and 45°
- One piece injected aluminum body
- TPR Handle, provides greater comfort
- 12" Bimetal blade included



Code	For blades of	Inner	Master
TC0247	12"	4	36

Type of packaging: Cover

STEEL HACKSAW FRAME

- High-tension hacksaw frame for 2 positions of blade 90° and 45°
- Steel bar
- Aluminum handle with TPR
- 12" Bi-metal blade included



Code	For blades of	Inner	Master
TC0252	12"	4	36

Type of packaging: Cover

ADJUSTABLE PROFESSIONAL METAL HACKSAW FRAME

- Reinforced steel frame and PVC coated metal handle
- 12" Bi-metal blade included



Code	For blades of	Inner	Master
TC0582	10" and 12"	4	36

Type of packaging: Cover

METAL HACKSAW FRAME

- Steel frame and ABS coated metal handle
- 12" Bi-metal blade included



Code	For blades of	Inner	Master
TC1919	10" and 12"	4	36

Type of packaging: Cover

STEEL HACKSAW FRAME



- High-tension hand saw through leverage
- High impact rigid frame
- 12" blade included



Code	For blades of	Inner	Master
WF0532	12"	4	36

Type of packaging: Cover

TUBULAR HACKSAW



- Aluminum die-cast handle
- Steel bar in polished finish
- 12" blade included



Code	For blades of	Inner	Master
WF0531	12"	4	36

Type of packaging: Cover

METAL HACKSAW FRAME



- ABS handle
- Steel body
- 12" blade included



Code	For blades of	Inner	Master
WF9662	12"	4	36

Type of packaging: Cover

METAL HACKSAW FRAME



- Aluminum handle and chromed steel hacksaw
- 12" blade included



Code	For blades of	Inner	Master
WF0533	10" and 12"	4	36

Type of packaging: Cover

COPING SAW



- Wooden handle
- 4 additional blades included:
 - Thick: all type of metals
 - Medium: all types of wood
 - Thin: for thick metals and hardwood
 - Extra thin: for thin metals and thin wood.



Code	Specification	Inner	Master
WF0540	4 blades	4	72

Type of packaging: Cover

ALUMINUM MINIHACKSAW

- 12" Bi-metal blade included
- For cutting in small spaces



Code	For blades of	Inner	Master
TC1920	10" and 12"	6	120

Type of packaging: Cover

PLASTIC MINIHACKSAW



- 12" blade included
- For cutting in small spaces



Code	For blades of	Inner	Master
WF9362	12"	6	120

Type of packaging: Cover

BI-METAL BLADE

- Made of hardened steel
- High durability
- High flexibility
- Available in 18dpp and 24 dpp



Code	DPP	Inner	Master
TC1977	18	50	500
TC1979	24	50	500
Blister of 2 pieces			
TC1978	18	20	120
TC1980	24	20	120

Type of packaging: Bulk / Blister

14" FOLDING CROSS WRENCH

- Arm thickness: 5/8"
- Hexagonal openings
- Opening sizes: (3/4", 13/16", 7/8" y 17 mm)
- Polished chrome finish



Code	Measure	Inner	Master
TC4054	14"	3	12

Type of packaging: Plastic cover

CHROMED CROSS WRENCH

- Arm thickness: 5/8"
- Hexagonal openings
- Opening sizes: (3/4", 13/16", 7/8" and 17 mm)
- Polished chrome finish
- Electrowelded arms for better resistance



Code	Measure	Inner	Master
TC0242	18"	6	12
TC0241	20"	6	12

Type of packaging: Bulk

14" CROSS WRENCH



- Arm thickness: 5/8"
- Hexagonal openings
- Opening sizes: (3/4", 13/16", 7/8" y 17 mm)
- Galvanized finishing
- Electrowelded arms for better resistance



Code	Measure	Inner	Master
WF4650	14"	6	18

Type of packaging: Bulk

DOUBLE-END TRUCK WRENCH

- Helps remove wheel studs and nuts on freight vehicles
- Hexagonal opening
- Dark finish



Code	Measure	Inner	Master
TC3372	7/8" - 15/16"	1	6
TC3373	1" - 1 1/16"	1	6
TC3374	1 1/16" - 1 1/4"	1	6
TC3375	1 1/8" - 7/8"	1	6
TC3376	30 mm - 33 mm	1	6

Type of packaging: Bulk

L WRENCH WITH TELESCOPIC HANDLE



- Extensible telescopic handle with slip-resistant grip of 35 cm to 52 cm
- Two size sockets: 17 mm and 19 mm (1/2" drive)
- Two size sockets: 21 mm and 23 mm (1/2" drive)



Code	Specification	Inner	Master
WF0289	L WRENCH	1	20T

Type of packaging: Blister

WHEEL RIM SEALANT

- Pressurizes and vulcanizes the wheel rim
- Easy to use, no need to use jack or tools
- Compatible with any wheel rim rim 13-17

* Note: You must consume completely. After using it can not be stored.



Code	Content	Inner	Master
TC5405	475 ml	4	12

Type of packaging: Tin

HYDRAULIC CLUTCH JACK, FAST LIFTING 3.5 TONS

- Made of steel
- Work height: Minimum: 3 3/4" (95 mm) Maximum: 21 5/8" (550 mm)



⚠ Do not exceed the maximum recommended load

Code	Maximum load	Length	Weight	Inner	Master
TC5152	3.5 tons	790 mm	44 kg	1	1

Type of packaging: Box

HYDRAULIC CLUTCH JACK, PROFESSIONAL 3 TONS

- Made of steel
- Work height: Minimum: 5 1/2" (140 mm) Maximum: 20 1/2" (520 mm)



⚠ Do not exceed the maximum recommended load

Code	Maximum load	Length	Weight	Inner	Master
TC5151	3 tons	720 mm	36.7 kg	1	1

Type of packaging: Box

HYDRAULIC CLUTCH JACK, FAST LIFTING 2.5 TONS

- Made of steel
- Work height: Minimum: 5 5/16" (135 mm) Maximum: 15 1/4" (387 mm)



⚠ Do not exceed the maximum recommended load

Code	Maximum load	Length	Weight	Inner	Master
TC5150	2.5 tons	560 mm	13.5 kg	1	1

Type of packaging: Box

HYDRAULIC CLUTCH JACK

- Made of steel
- Capacity 2 TON
- Work height: Minimum: 5 1/4" (133 mm) Maximum: 13 1/2" (343 mm)
- Compact design



⚠ Do not exceed the maximum recommended load

Code	Maximum load	Length	Weight	Inner	Master
TC1439	2 tons	440 mm	8.3 kg	1	1

Type of packaging: Box

HYDRAULIC CLUTCH JACK



- Made of steel
- Capacity 1.5 TON
- Work height: Minimum: 5 1/8" (130 mm) Maximum: 11 13/16" (300 mm)
- Compact design



⚠ Do not exceed the maximum recommended load

Code	Maximum load	Length	Weight	Inner	Master
★WF9817	1.5 tons	412 mm	6.3 kg	1	1

Type of packaging: Box

VEHICLE STAND

- High carbon steel body, pyramid shape.
- Welded and reinforced for better support and resistance.



*Price per box 2 pieces

Code	Maximum load	Inner	Master
TC3359	3 tons	1	1
TC3360	6 tons	1	1

Type of packaging: Box / 2 pieces

2 TON ENGINE HOIST

- Capacity of 2 tons
- Elevation capacity of 2.30m
- Width 76 cm
- Lifting length of 2ton / 179 cm
- Foldable body
- Handle for lift and lower control



Foldable for storage and space saving



⚠ Do not exceed the maximum recommended load



WARNING

Do not place any part of the body under the load while using the hydraulic boom.

Code	Capacity	Inner	Master
TC3363	2 tons	1	1

Type of packaging: Box

PORTO POWER HYDRAULIC 10 TON

- Use in tinsmithery for chassis straightening
- Capacity: 10 tons
- Maximum lift: 135 mm
- Minimum cylinder height: 356 mm

Included:

- V-Base
- Connector
- Sprocket cap
- Rubber head
- 10-ton pump
- Separator wedge
- Piston unit
- Hydraulic hose
- Extensions of: 520 mm, 362 mm, 265 mm y 110 mm
- Base plate
- Piston pointer
- Plunger pointer
- Top of the crack



Code	Capacity	Inner	Master
TC3371	10 tons	1	1

Type of packaging: Plastic case

PLASTIC MECHANIC CREEPER

40" / 101.6 CM

- Headrest cushion for more comfort
- Made of high density polyethylene
- Load capacity: 140kg
- 6 turning wheels of polypropylene - pvc



CUSHIONED MECHANIC CREEPER

36" / 91.44 CM

- Headrest cushion for more comfort
- Made of highly steel frame
- Load capacity: 150kg
- Heavy duty tubular steel frame
- 6 turning wheels of polypropylene



Code	Measures	Inner	Master
TC3355	40" x 40"	1	1

Type of packaging: Box

Code	Measures	Inner	Master
TC3354	36" x 36"	1	1

Type of packaging: Box

BOOSTER CABLES

- Rubber and copper coated clamps to prevent short circuits.
- Copper cable



Code	Gauge	Current maximum	Length	Inner	Master
TC2079	8 AWG	280 A	3.5 m	2	10
TC4399	6 AWG	360 A	3.5 m	2	10

Type of packaging: Plastic cover

BOOSTER CABLES

- Rubber and copper coated clamps to prevent short circuits.
- Copper cable

Wolfox



Code	Gauge	Maximum Current	Length	Inner	Master
WF0564	10 AWG	190 A	2 m	5	20
WF1110	10 AWG	120 A	3 m	5	20

Type of packaging: Cover

OIL FILTER WRENCH

- Ideal for installing or replacing filters
- Carbon steel strap
- Strap with three holding points
- Vinyl coated handle for better grip.



Code	For filters of	Inner	Master
TC3356	2 3/4" a 2 1/4"	6	36
TC3357	3 7/16" a 3 3/4"	6	36

Type of packaging: Blister

BAND WRENCH FOR OIL FILTER

- Ideal for installing or replacing filters up to 6"
- Polyester anti-slip band
- Metal body with plastic lid
- 1/2" Drive



Code	For filters of	Inner	Master
TC3358	up to 6"	4	36

Type of packaging: Blister

1,000 W CURRENT INVERTER

- Replaceable fuse
- Power cord included for connecting to the battery.
- 1 USB port
- 2 grounded contacts 115V~
- Turns off automatically with low battery, peak voltage, or power failures



SPECIFICATIONS	
Input V.	12.8 Vcc
Output USB V.	5 Vcc
Output V.	115 V~
Frequency	60 Hz
Power	1000 W
Current / USB Output	2,100 mA



Code	Power	Inner	Master
TC4347	1000 W	1	6

Type of packaging: Box

100 2 CURRENT INVERTER

- Replaceable fuse
- Car adapter adjustable to 45°
- 1 USB port
- 1 grounded contact 115V~
- Turns off automatically with low battery, peak voltage or power failure



SPECIFICATIONS	
Input V.	12.8 Vcc
Output USB V.	5 Vcc
Output V.	115 V~
Frequency	60 Hz
Power	100 W
Current / USB Output	2,100 mA



Code	Power	Inner	Master
TC4345	100 W	1	10

Type of packaging: Box

SINGLE HEAD TIRE PRESSURE GAUGE

- Brass body
- Zamac head
- Aluminum ruler



Code	Capacity	Inner	Master
TC2015	Simple 50 lbs	12	72
TC2016	Simple 120 lbs	12	72T

Type of packaging: Blister

400 W CURRENT INVERTER

- Replaceable fuse
- Car adapter
- Alligator clip cables included to connect a battery
- 1 USB port
- 2 grounded contacts 115V~
- Turns off automatically with low battery, peak voltage or power failure



Code	Power	Inner	Master
TC4346	400 W	1	10

Type of packaging: Box

DOUBLE HEAD TIRE PRESSURE GAUGE

- Brass body
- Zamac head
- Aluminum ruler



Code	Capacity	Inner	Master
TC2019	Double 120 lbs	12	72
TC2020	Double 160 lbs	12	72T

Type of packaging: Blister

FEELER GAUGE SET 32 BLADES

- Tempered steel blades
- One brass blade for measurements.
- Engraved in inches and millimeters.
- Range: 0.0015 - 0.035"



Code	Page number	Size	Inner	Master
TC3366	32	3 5/16" x 1/2"	6	36

Type of packaging: Blister

FEELER GAUGE SET 26 BLADES

- Tempered steel blades
- Engraved in inches and millimeters.
- Range: 0.038 - 0.635"



Code	Page number	Size	Inner	Master
TC3367	26	3" x 3"	6	36

Type of packaging: Blister

FEELER GAUGE SET 22 BLADES

- Tempered steel blades
- Engraved in inches and millimeters.
- Range: 0.004 "-0.027"



Code	Page number	Size	Inner	Master
TC3369	22	3 5/16" x 1/2"	6	36

Type of packaging: Blister

FEELER GAUGE SET 12 BLADES

- Tempered steel blades
- Engraved in inches and millimeters.
- Range: 0.203 "-0.660"



Code	Page number	Size	Inner	Master
TC3368	12	3" X 1/2"	6	36

Type of packaging: Blister

PRY BAR

- Made of carbon steel
- Double heat treatment
- Beveled palette



Code	Diameter	Length	Weight	Inner	Master
TC1205	7/8"	1.00 m	3.0 kg	2	3
TC1206	7/8"	1.25 m	3.9 kg	2	3
TC1207	1"	1.50 m	5.7 kg	2	3
TC1208	1"	1.75 m	6.9 kg	2	3
TC5176	1"	1.75 m	11 kg	2	3

Type of packaging: Bulk

PRY BAR

- Made of carbon steel
- Double heat treatment
- Beveled palette



Code	Diameter	Length	Weight	Inner	Master
TC0871	1/2"	12" (30 cm)	0.44 kg	3	12
TC0799	5/8"	18" (46 cm)	0.89 kg	3	12
TC0800	3/4"	24" (60 cm)	1.63 kg	3	12
TC0801	3/4"	30" (76 cm)	2.00 kg	3	12
TC0802	3/4"	36" (92 cm)	2.37 kg	3	12

Type of packaging: Bulk

DOUBLE-SIDED BAR BENDING KEY 1/2" AND 5/8"

- Made of carbon steel
- 5/8" side: ideal to bend and straighten steel-rods of 1/2"
- 1/2" side: ideal to bend and straighten steel-rods of 3/8"



Code	Sides	Inner	Master
TC2055	Sides 1/2" and 5/8"	3	24

Type of packaging: Bulk

CHISEL

- Made of carbon steel
- Double heat treatment



Large head which increases the area of impact

Code	Wedge	Inner	Master
Length of 5 "			
TC1931	1/4" x 1/4"	6	36
Length of 6 "			
TC1932	5/16" x 5/16"	6	36
TC1933	3/8" x 3/8"	6	36
TC1936	1/2" x 1/2"	6	36
TC1940	5/8" x 5/8"	6	36
TC1944	3/4" x 3/4"	6	36
Length of 8 "			
TC1934	3/8" x 3/8"	6	36
TC1937	1/2" x 1/2"	6	36
TC1941	5/8" x 5/8"	6	36
TC1945	3/4" x 3/4"	6	36
TC1948	7/8" x 7/8"	6	36
TC1951	1" x 1"	6	36
Length of 10 "			
TC1935	3/8" x 3/8"	6	36
TC1938	1/2" x 1/2"	6	36
TC1942	5/8" x 5/8"	6	36
TC1946	3/4" x 3/4"	6	36
TC1949	7/8" x 7/8"	6	36
TC1952	1" x 1"	6	36
Length of 12 "			
TC1939	1/2" x 1/2"	6	36
TC1943	5/8" x 5/8"	6	36
TC1947	3/4" x 3/4"	6	36
TC1950	7/8" x 7/8"	6	36
TC1953	1" x 1"	6	36

Type of packaging: Plastic hanger

B | SCALES | PUMPS TO INFLATE

KITCHEN SCALE

- Made of plastic
- Removable tray
- Needle indicator
- Easy to read display
- 2 measuring scales: kg / lb

Wolfox



Code	Capacity	Inner	Master
WF9538	1 kg	4	24
WF9539	3 kg	4	24
WF9540	5 kg	4	24

Type of packaging: Box

INFLATING HAND PUMP

- Made of steel
- Two hand pumping
- Flat base for better support
- 60 cm hose
- Valves included



Code	Length	Pressure	Inner	Master
TC4276	22"	130 PSI	6	12

Type of packaging: Bulk

INFLATING HAND PUMP

- Metal body
- Ergonomic plastic handle
- Two-hand pumping
- 60 cm hose

Wolfox



The WF1006 model includes valves



Code	Length	Pressure	Inner	Master
WF1005	15"	70 PSI	10	20
WF1006	20"	70 PSI	6	12

Type of packaging: Bag

BICYCLE PATCH KIT

- Content:
 - 1 Glue tube
 - 6 Patches
 - 2 Rubber tubes
 - 1 Plastic case
 - 1 Sandpaper

Wolfox



Code	Content	Inner	Master
WF5901	11 pieces	25	500

Type of packaging: Plastic case

DYNAMOMETER

- Pull type spring scale
- 2 engraved measuring scales: kg and lb

Wolfox



Code	Capacity	Inner	Master
WF9871	12 kg	12	12
WF9872	25 kg	12	12
WF9873	50 kg	6	6
WF9874	100 kg	6	6

Type of packaging: Bulk

INFLATING MINI PUMP

- Made of metal
- One hand pumping
- Includes manometer



Code	Length	Pressure	Inner	Master
TC4275	10"	10 PSI	8	48

Type of packaging: Blister

INFLATING FOOT PUMP WITH MANOMETER

- Pedal with slip resistant rubber protection
- 60 cm reinforced hose with nylon cover
- Analog manometer
- Valves included

Wolfox



Code	Pressure	Inner	Master
WF1001	70 PSI	12	24

Type of packaging: Box

BIT BRACE

- Chrome steel body
- Steering wheel and knob on hickory wood
- 12 point reversible ratchet
- Grip with double clamp in hardened carbon steel.



Code	Measure	Inner	Master
TC0009	12"	2	24

Type of packaging: Bulk

**HIGH-PERFORMANCE DRILL BIT
HSS M-35**

- Made of HSS M-35 steel with 5% cobalt
- Tip angle: 118°
- For use in iron, wood and plastic
- Straight shank



Code	Measure	Length	Inner	Master
TC0488	1/16"	1"	10	800
TC0489	5/64"	1"	10	800
TC0490	3/32"	2"	10	800
TC0491	7/64"	2"	10	800
TC0492	1/8"	2"	10	800
TC0493	9/64"	2"	10	300
TC0494	5/32"	3"	10	300
TC0495	11/64"	3"	10	300
TC0496	3/16"	3"	10	300
TC0497	13/64"	3"	10	300
TC0498	7/32"	3"	10	200
TC0499	15/64"	3"	10	200
TC0500	1/4"	4"	10	100
TC0501	17/64"	4"	10	100
TC0502	9/32"	4"	5	50
TC0503	19/64"	4"	5	50
TC0504	5/16"	4"	5	50
TC0505	21/64"	4"	5	50
TC0506	11/32"	5"	5	50
TC0507	23/64"	5"	5	50
TC0508	3/8"	5"	5	50
TC0509	25/64"	5"	5	50
TC0510	13/32"	5"	5	50
TC0511	27/64"	5"	5	50
TC0512	7/16"	5"	5	50
TC0513	29/64"	5"	5	50
TC0514	15/32"	6"	5	50
TC0515	31/64"	6"	5	50
TC0516	1/2"	6"	5	50
Reduced shank to 1/2"				
TC0517	9/16" Shank 1/2"	6"	3	20
TC0518	5/8" Shank 1/2"	7"	4	20
TC0519	3/4" Shank 1/2"	7"	2	20

Type of packaging: Bulk

HSS DRILL BIT FOR IRON

- Manufactured in HSS steel
- Black oxide finish
- To be used in iron
- Straight shank



Wolfox

Code	Measure	Length	Inner	Master
WF0205	1/32"	1"	10	800
WF0206	3/64"	1"	10	800
WF0207	1/16"	1"	10	800
WF0208	5/64"	2"	10	800
WF0209	3/32"	2"	10	800
WF0210	7/64"	2"	10	800
*WF0211	1/8"	2"	10	800
WF0212	9/64"	2"	10	600
WF0213	5/32"	3"	10	600
WF0214	11/64"	3"	10	600
*WF0215	3/16"	3"	10	400
WF0216	13/64"	3"	10	400
WF0217	7/32"	3"	10	200
WF0218	15/64"	3"	10	200
WF0219	1/4"	4"	10	200
WF0220	9/32"	4"	10	200
WF0221	5/16"	4"	5	50
WF0222	11/32"	5"	5	50
WF0223	3/8"	5"	5	50
WF0224	7/16"	5"	5	50
WF0225	1/2"	6"	5	50

Type of packaging: Bulk

**HIGH-PERFORMANCE DRILL BIT
HSS M-35**

- Made of HSS M-35 steel with 5% cobalt
- Tip angle: 118°
- To be used in iron, wood and plastic
- Straight shank



Code	Measure	Length	Inner	Master
TC4320	3/32"	2"	10	100
TC4321	7/64"	2"	10	100
TC4322	1/8"	2"	10	100
TC4323	9/64"	2"	10	100
TC4324	5/32"	3"	10	100
TC4325	11/64"	3"	10	100
TC4326	3/16"	3"	10	100
TC4327	7/32"	3"	10	100
TC4328	1/4"	4"	10	100
TC4329	5/16"	4"	10	100
TC4330	3/8"	5"	10	100
TC4331	7/16"	5"	4	50
TC4332	1/2"	6"	4	50

Type of packaging: Blister

MASONRY DRILL BIT

- Tungsten carbide tip
- For use in concrete, marble, brick and stone
- Straight shank



Code	Measure	Length	Inner	Master
TC0461	1/8"	3"	10	500
TC0462	3/16"	4"	10	500
TC0463	3/16"	6"	10	500
TC0464	1/4"	4"	10	500
TC0465	1/4"	6"	10	500
TC0466	1/4"	12"	10	500
TC0467	5/16"	4"	10	500
TC0468	5/16"	6"	10	500
TC0469	5/16"	12"	10	200
TC0470	3/8"	4"	5	250
TC0471	3/8"	6"	5	250
TC0472	3/8"	12"	5	100
TC0474	7/16"	6"	5	200
TC0475	1/2"	6"	5	200
TC0476	1/2"	12"	5	100
TC0477	5/8"	6"	5	100
TC0478	5/8"	12"	5	50
TC0479	3/4"	6"	6	50
Reduced shank to 1/2"				
TC0480	3/4"	12"	6	50
TC0481	7/8"	6"	6	50
TC0482	7/8"	12"	6	50
TC0483	1"	6"	6	50
TC0484	1"	12"	5	40

Type of packaging: Bulk

MASONRY DRILL BIT SDS

- Tungsten carbide tips
- For use in concrete, marble, brick, stone, drywall, etc.



Code	Measure	Length	Inner	Master
TC0522	3/16"	6"	5	100
TC0523	3/16"	8"	5	100
TC0524	1/4"	4"	5	250
TC0525	1/4"	6"	5	250
TC0526	1/4"	8"	5	100
TC0527	1/4"	10"	5	100
TC0528	5/16"	6"	5	50
TC0529	5/16"	8"	5	50
TC0530	5/16"	12"	5	50
TC0531	3/8"	6"	5	50
TC0532	3/8"	8"	5	50
TC0533	3/8"	12"	5	50
TC0534	3/8"	18"	5	25
TC0535	7/16"	6"	5	50
TC0536	7/16"	12"	5	50
TC0537	1/2"	6"	5	50
TC0538	1/2"	8"	5	50
TC0539	1/2"	12"	5	50
TC0540	1/2"	16"	5	25
TC0541	1/2"	18"	5	25
TC0542	9/16"	6"	5	50
TC0543	9/16"	12"	5	50
TC0544	5/8"	6"	5	50
TC0545	5/8"	8"	5	50
TC0546	5/8"	12"	5	50
TC0547	5/8"	18"	5	20
TC0548	5/8"	24"	5	20
TC0549	3/4"	8"	5	20
TC0550	3/4"	12"	5	20
TC0551	3/4"	18"	3	20
TC0552	7/8"	8"	5	20
TC0553	7/8"	12"	5	20
TC0554	7/8"	18"	2	20
TC0555	1"	10"	4	20
TC0556	1"	12"	4	20
TC0557	1"	18"	2	10

Type of packaging: Bulk

MASONRY DRILL BIT

- Tungsten carbide tip
- To use in concrete, marble, brick and stone
- Straight shank



Code	Measure	Length	Inner	Master
TC4312	3/16"	4"	10	100
TC4313	1/4"	4"	10	100
TC4314	1/4"	6"	10	100
TC4315	5/16"	4"	10	100
TC4316	5/16"	6"	10	100
TC4318	3/8"	6"	10	100
TC4319	1/2"	6"	10	100

Type of packaging: Blister

MASONRY DRILL BIT



- Tungsten carbide tips
- To be used in stone, marble, panel, concrete, brick, etc.
- Straight shank



Type of Tip



Code	Measure	Length	Inner	Master
WF1101	3/16"	4"	10	500
WF0226	3/16"	6"	10	500
WF1103	1/4"	4"	10	500
WF1104	1/4"	6"	10	500
WF1106	1/4"	12"	10	500
WF1107	5/16"	4"	10	500
WF1109	5/16"	6"	10	500
WF0227	5/16"	12"	10	200
WF1112	3/8"	4"	10	250
WF1113	3/8"	6"	10	250
WF0228	3/8"	12"	10	100
WF1118	1/2"	6"	10	250
WF0229	1/2"	12"	5	100
WF0230	5/8"	6"	5	100

Type of packaging: Bulk

HSS 13 PIECE DRILL BIT KIT

- Made of molybdenum steel M2 / M7 high speed (HSS)
- Black oxide finish
- To be used in iron
- Straight shank

Contains:

Measure	Length	Measure	Length
1/16"	1 3/4"	19/64"	4 1/2"
5/64"	2"	5/16"	4 1/2"
3/32"	2 1/4"	21/64"	4 1/2"
7/64"	2 1/2"	11/32"	5"
1/8"	2 1/2"	23/64"	5"
9/64"	2 3/4"	3/8"	5"
5/32"	3"	25/64"	5 1/4"
11/64"	3 1/4"	13/32"	5 1/4"
3/16"	3 1/2"	27/64"	5 1/2"
13/64"	3 1/2"	7/16"	5 1/2"
7/32"	3 3/4"	29/64"	5 1/2"
15/64"	3 3/4"	15/32"	6"
1/4"	4"	31/64"	6"
17/64"	4 1/4"	1/2"	6"
9/32"	4 1/4"		

Code	Content	Inner	Master
TC0485	29 pieces	1	20

Type of packaging: Metallic Case



HSS 13 PIECE DRILL BIT KIT

- Made of molybdenum steel M2 / M7 high speed (HSS)
- Black oxide finish
- To be used in iron
- Straight shank

Contains:

Measure	Length
1/16"	1 3/4"
5/64"	2"
3/32"	2 1/4"
7/64"	2 1/2"
1/8"	2 1/2"
9/64"	2 3/4"
5/32"	3"
11/64"	3 1/4"
3/16"	3 1/2"
13/64"	3 1/2"
7/32"	3 3/4"
15/64"	3 3/4"
1/4"	4"

Code	Content	Inner	Master
TC0448	13 pieces	4	48

Type of packaging: Case



7-PIECE HSS DRILL BIT SET

- Made of molybdenum steel M2 / M7 high speed (HSS)
- Black oxide finish
- To be used in iron
- Straight shank

Contains:

Measure	Length
1/16"	1 3/4"
3/32"	2 1/4"
1/8"	2 1/2"
5/32"	3"
3/16"	3 1/2"
7/32"	3 3/4"
1/4"	4"



Code	Content	Inner	Master
TC0446	7 pieces	6	48

Type of packaging: Blister

5-PIECE HSS DRILL BIT SET

- Made of molybdenum steel M2 / M7 high speed (HSS)
- Black oxide finish
- To be used in iron
- Straight shank

Contains:

Measure	Length
1/16"	1 3/4"
3/32"	2 1/4"
1/8"	2 1/2"
3/16"	3 1/2"
1/4"	4"



Code	Content	Inner	Master
TC0445	5 pieces	12	48

Type of packaging: Blister

4-PIECE CONCRETE DRILL BIT SET

- Tungsten carbide tips
- To be used in concrete, brick marble, stone and panel
- Straight shank

Contains:

Measure	Length
3/16"	4"
1/4"	4"
5/16"	4"
3/8"	4"



Code	Content	Inner	Master
TC0460	4 pieces	6	60

Type of packaging: Blister

5-PIECE HSS DRILL BIT SET



- Manufactured in HSS steel
- Tip angle: 118°
- To be used in iron, wood and plastic
- Straight shank

Contains:

Measure	Length
1/16"	1"
3/32"	2"
1/8"	2"
3/16"	3"
1/4"	4"

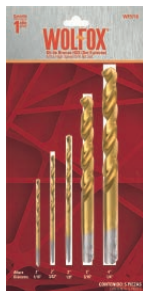

Type of Tip

Code	Content	Inner	Master
WF9716	5 pieces	12	48

Type of packaging: Blister

13-PIECE HSS DRILL BIT SET



- Manufactured in HSS steel
- Tip angle: 118°
- For use in iron, wood and plastic
- Straight shank

Contains:

Measure	Length
1/16"	1"
5/64"	2"
3/32"	2"
7/64"	2"
1/8"	2"
9/64"	2"
5/32"	3"
11/64"	3"
3/16"	3"
13/64"	3"
7/32"	3"
15/64"	3"
1/4"	4"

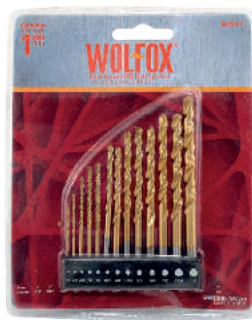

Type of Tip

Code	Content	Inner	Master
WF9717	13 pieces	4	48

Type of packaging: Blister

4-PIECE CONCRETE DRILL BIT SET



- Tungsten carbide tips
- To be used in stone, marble, panel, concrete, brick, etc.
- Straight shank

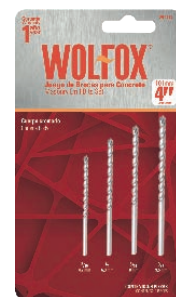

Type of Tip

Code	Content	Inner	Master
WF1119	4 pieces	10	60

Type of packaging: Blister

ROMAN

- Tungsten carbide blade
- Rectified
- Ball bealing for softer and faster cutting.
- 1/4" shank



Code	Measure	Inner	Master
TC2389	1 3/8" x 7/8"	6	36

Type of packaging: Blister

CLASSIC

- Tungsten carbide blade
- Rectified
- Ball bealing for softer and faster cutting.
- 1/4" shank



Code	Measure	Inner	Master
TC2394	1 3/8" x 1 1/16"	6	36

Type of packaging: Blister

OGEE

- Tungsten carbide blade
- Rectified
- Ball bealing for softer and faster cutting.
- 1/4" shank



Code	Measure	Inner	Master
TC2387	1 1/8" x 1/2"	6	36
TC2388	1 3/8" x 9/16"	6	36

Type of packaging: Blister

CLASSICAL MOLDING

- Tungsten carbide blade
- Rectified
- Ball bealing for softer and faster cutting.
- 1/4" shank



Code	Measure	Inner	Master
TC2395	1 1/8" x 1/2"	6	36

Type of packaging: Blister

ROUND OVER MOLDING

- Tungsten carbide blade
- Rectified
- Ball bealing for softer and faster cutting.
- 1/4" shank



Code	Measure	Inner	Master
TC2403	1" x 1"	6	36
TC2404	1 1/4" x 5/8"	6	36
TC2405	1 1/2" x 3/4"	6	36

Type of packaging: Blister

CORNER ROUND

- Tungsten carbide blade
- Rectified
- Ball bealing for softer and faster cutting.
- 1/4" shank



Code	Measure	Inner	Master
TC2391	1" x 1"	6	36
TC2392	1 1/4" x 5/8"	6	36
TC2393	1 1/2" x 3/4"	6	36

Type of packaging: Blister

RABBETING

- Tungsten carbide blade
- Rectified
- Ball bealing for softer and faster cutting.
- 1/4" shank



Code	Measure	Inner	Master
TC2390	1 1/4" x 1/2"	6	36

Type of packaging: Blister

CHAMFER

- Tungsten carbide blade
- Rectified
- Ball bealing for softer and faster cutting.
- 1/4" shank



Code	Measure	Inner	Master
TC2406	1 1/4" x 1/2"	6	36

Type of packaging: Blister

COVE

- Tungsten carbide blade
- Rectified
- Ball bealing for softer and faster cutting.
- 1/4" shank



Code	Measure	Inner	Master
TC2407	1 1/8" x 1/2"	6	36

Type of packaging: Blister

CORE BOX

- Tungsten carbide blade
- Rectified
- 1/4" shank



Code	Measure	Inner	Master
TC2408	1/4" x 1/4"	6	36
TC2409	3/8" x 3/8"	6	36
TC2410	1/2" x 1/2"	6	36
TC2411	3/4" x 3/4"	6	36
TC2412	1/2" x 7/32" with ball bearing	6	36

Type of packaging: Blister

V-GROOVE

- Tungsten carbide blade
- Rectified
- 1/4" shank



Code	Measure	Inner	Master
TC2413	3/8" x 3/8"	6	36
TC2414	1/2" x 1/2"	6	36
TC2415	7/8" x 7/8"	6	36

Type of packaging: Blister

2-FLUTE STRAIGHT

- Tungsten carbide blade
- Rectified
- 1/4" shank



Code	Measure	Inner	Master
TC2396	1/4" x 1/4"	6	36
TC2397	1/4" x 1/4"	6	36
TC2398	5/16" x 5/16"	6	36
TC2399	3/8" x 3/8"	6	36
TC2400	1/2" x 1/2"	6	36
TC2401	5/8" x 5/8"	6	72
TC2402	3/4" x 3/4"	6	72

Type of packaging: Blister

B | DRILL BITS | FOR ROUTER

DOVETAIL

- Tungsten carbide blade
- Rectified
- 1/4" shank



Code	Measure	Inner	Master
TC2416	1/2" x 1/2"	6	36

Type of packaging: Blister

15-PIECE ROUTER BIT SET

- Tungsten carbide blade
- Rectified
- Ball bearing for softer and faster cutting.
- 1/4" shank

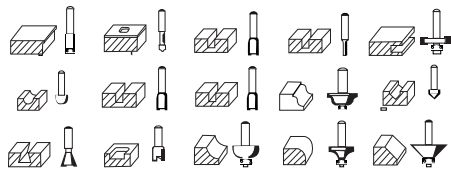

Code	Content	Inner	Master
TC3455	15 drill bit	1	24

Type of packaging: Wood-Acrylic Case

8-PIECE ROUTER BIT SET

- Tungsten carbide blade
- Rectified
- Ball bearing for softer and faster cutting
- 1/4" shank

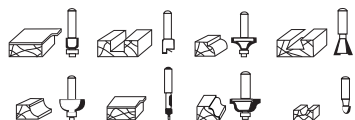

Code	Content	Inner	Master
TC3454	8 drill bit	2	24

Type of packaging: Wood-Acrylic Case

5-PIECE ROUTER BIT SET

- Tungsten carbide blade
- Rectified
- Ball bearing for softer and faster cutting
- 1/4" shank



Code	Content	Inner	Master
TC3453	5 drill bit	2	16

Type of packaging: Wood-Acrylic Case

WOOD DRILL BIT SPADE-SHAPED

- Made of and treated in carbon steel
- Sharp tip and blades
- Hexagonal shank prevents spinning in drill chuck or extension
- 1/4" Straight Shank



Code	Measure	Inner	Master
TC0803	1/4"	6	72
TC0804	5/16"	6	72
TC0805	3/8"	6	72
TC0806	7/16"	6	72
TC0807	1/2"	6	72
TC0808	9/16"	6	72
TC0809	5/8"	6	72
TC0810	3/4"	6	72
TC0811	7/8"	6	72
TC0812	1"	6	72
TC0813	1"	6	72
TC0814	1"	6	72

Type of packaging: Blister

6 PIECES SPADE-SHAPED WOOD DRILL BIT SET

- Made of and treated in carbon steel
- Sharp tip and blades
- Hexagonal shank prevents spinning in drill chuck or extension
- 1/4" Straight Shank

Contains:

Measure
3/8"
1/2"
5/8"
3/4"
7/8"
1"



Code	Content	Inner	Master
TC4311	6 pieces	4	20

Type of packaging: Blister

GLASS AND TILE DRILL BIT

- Tungsten carbide tip
- Steel body
- Rectified
- Spade-shaped tip for easy drilling
- 1/4" Straight Shank



Code	Measure	Length	Inner	Master
TC2442	1/8"	2 1/4"	6	72
TC2443	3/16"	2 1/2"	6	72
TC2444	1/4"	2 1/2"	6	72
TC2445	5/16"	2 3/4"	6	72
TC2446	3/8"	3"	6	72
TC2447	1/2"	3 1/2"	6	36

Type of packaging: Blister

TOOLCRAFT LARGE DISPLAY RACK DRILL BITS

- Made with mdf 1/2" with matte white laminate and band covers edges of the same tone
- Measures:
 - Height: 30 cm
 - Width: 42 cm
 - Depth: 32 cm



*Product not included

Code	Capacity	Inner	Master
TC5437	24 drill bits models	1	1

TOOLCRAFT SMALL DISPLAY RACK DRILL BITS

- Made with MDF 1/2" with matte white laminate and band covers edges of the same tone
- Measures:
 - Height: 17 cm
 - Width: 24 cm
 - Depth: 22 cm



*Product not included

Code	Capacity	Inner	Master
TC5441	12 drill bits models	1	1



TOOLBOXES

25" 2-IN-1 ROLLING TOOLBOX

- Made of polypropylene
- Plastic latches
- Includes tray
- Includes organizer
- Detachable box

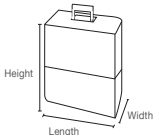

Nested design to optimize shipment and storage

Code	Length	Width	Height	Weight	Inner	Master
TC4046	18"	10"	25"	5.0 kg	1	2

Type of packaging: Bulk

3-PIECE PROFESSIONAL TOOLBOX SET

- Stainless steel case with lid and polypropylene base
- Metal latches
- Each box includes tray
- Includes hasp
- 3 pieces in one single box

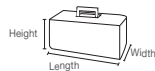

Nested design to optimize shipment and storage

Code	Contains	Inner	Master
TC4042	TC4043, TC4044, TC4045	1	1

Type of packaging: Bulk

PROFESSIONAL TOOLBOX

- Stainless steel case with lid and polypropylene base
- Metal latches
- Includes tray
- Includes hasp

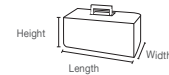

Code	Length	Width	Height	Weight	Inner	Master
TC4043	15"	6"	7"	1.7 kg	2	12
TC4044	20"	9"	9"	3.2 kg	2	6
TC4045	23"	11"	11"	4.3 kg	1	4

Type of packaging: Bulk

METAL TOOLBOX

- High-gloss red paint finish metal box
- Metal latches
- Includes tray
- Includes hasp
- Riveted polypropylene handle

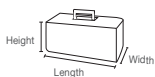

Code	Length	Width	Height	Weight	Inner	Master
TC3301	20"	7"	6"	2.3 kg	2	6
TC3303	24"	10"	8"	4.0 kg	2	4

Type of packaging: Bulk

TITAN TOOLBOX

- Made of polypropylene
- Plastic latches
- Includes tray
- Includes hasp
- Ergonomic handle

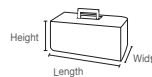

Nested design to optimize shipment and storage

Code	Length	Width	Height	Weight	Inner	Master
WF3272	16"	7"	7"	1.0 kg	4	14
WF3270	19"	8"	8"	1.5 kg	4	12
WF3271	22"	10"	10"	2.2 kg	4	10

Type of packaging: Bulk

Wolfbox

3-TON PALLET TRUCK

- Steel body
- Recommended for outdoor use
- For heavy loads
- Does not scratches the surfaces



Code	Arms length	Minimum elevation	Maximum elevation	Total width	Inner	Master
TC4392	1.22 m	75 mm	190 mm	68 cm	1	1

Type of packaging: Bulk

2.5-TON PALLET TRUCK

- Steel body
- Recommended for indoor use
- For heavy loads
- Does not scratches the surfaces



Code	Arms length	Minimum elevation	Maximum elevation	Total width	Inner	Master
TC4391	1.22 m	75 mm	185 mm	68 cm	1	1

Type of packaging: Bulk

FOLDING PLATFORM CART

- Made of steel
- Solid polypropylene wheels 5"
- Brake on wheels to immobilize platform
- Platform height: 16.5 cm
- Total height with tubular support: 90 cm
- Weight: 11.8 kg

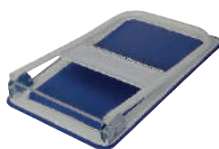

Load Capacity
300 kg

Code	Measure	Inner	Master
TC5329	91 x 61 cm	1	1

Type of packaging: Box

SQUARE PLATFORM WITH WHEELS

- Made of polypropylene
- Solid polypropylene wheels 3"
- Brake on 2 wheels to immobilize platform
- Height: 9 cm



Load Capacity
500 kg

Code	Measure	Inner	Master
TC5330	Base: 46 x 77 cm	1	4

Type of packaging: Box

THREE-CORNERED PLATFORM WITH WHEELS

- Made of steel
- Solid polyethylene wheels 1 1/8"
- Height: 4.5 cm



Load Capacity
60 kg

Code	Measure	Inner	Master
TC5331	Base: 15 cm x side	4	36

Type of packaging: Bulk

HOIST

- Made of high-carbon steel
- Triple gear
- Maximum lifting: 3 m
- Forged hook with security latch and 360° turn.



For your safety never exceed the indicated weight limit

Code	Maximum load capacity	Weight	Chain length	Link thickness	Hanger opening	Inner	Master
TC4400	1/2 ton	11 kg	3 m	6 mm	23 mm	1	1
TC4401	1 ton	11 kg	3 m	6 mm	26 mm	1	1
TC4403	2 tons	15.5 kg	3 m	6 mm	33 mm	1	1
TC4404	3 tons	22 kg	5.8 m	8 mm	37 mm	1	1
TC4405	5 tons	36 kg	5.8 m	10 mm	40 mm	1	1
TC4406	10 tons	68 kg	11.8 mm	10 mm	52 mm	1	1

Type of packaging: Box

LEVER HOIST

- Made of steel
- Maximum lifting: 1.5 m
- Forged hook with security latch and 360° turn.
- Lever that minimizes the effort when lifting the load



For your safety never exceed the indicated weight limit

Code	Maximum load capacity	Standard elevation	Weight	Chain length	Hanger opening	Inner	Master
TC4543	3/4 ton	1.5 m	7 kg	1.63 m	27 mm	1	1
TC4544	1 ton	1.5 m	7 kg	1.63 m	27 mm	1	1
TC4545	1 1/2 ton	1.5 m	10 kg	1.62 m	34 mm	1	1
TC4546	3 tons	1.5 m	17.5 kg	1.77 m	38 mm	1	1
TC4547	6 tons	1.5 m	28.5 kg	3.51 m	48 mm	1	1

Type of packaging: Box

WINCH

- Solid construction gear, 4:1 relation
- Double gear
- Forged steel hook
- Soft handle (prevents fatigue)
- Anti-corrosive anodized black paint



For your safety never exceed the indicated weight limit

Code	Maximum load capacity	ca-Weight	Cable diameter	Cable length	Inner	Master
TC0847	544 kg	3.45 kg	4.1 mm	9.5 m	1	6
TC0848	907 kg	5.6 kg	5 mm	9.5 m	1	6

Type of packaging: Box

WINCH

- Two forged steel hooks
- Chrome plated body which prevents corrosion

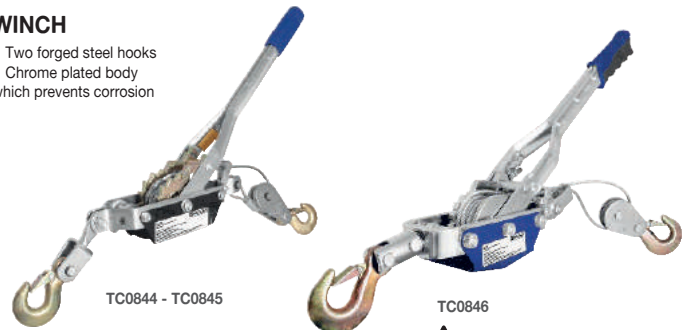

For your safety never exceed the indicated weight limit

Code	Maximum capacity	Weight	Cable diameter	Cable length	Inner	Master
TC0844	1 ton	2.05 kg	4.5 mm	2.2 m	2	6
TC0845	2 tons	2.8 kg	5 mm	3 m	1	6
TC0846	4 tons	4.95 kg	5 mm	3.5 m	1	3

Type of packaging: Box

CABLE WINCH / TIRFOR

- Aluminum body
- 20 m steel cable
- Steel plate and extension

Device to lift, pull, tighten and secure load. Works vertically, horizontally and inclined.



For your safety never exceed the indicated weight limit

Code	Maximum load capacity	Tube length	Cable diameter	Cable length	Inner	Master
TC4407	1.6 tons	70 + 120 cm	11 mm	20 m	1	1
TC4408	3.2 tons	70 + 120 cm	16mm	20 m	1	1

Type of packaging: Box

TROLLEY

- Made of forged steel
- Electrostatic paint
- Maintenance-free sealed ball sealed ball bearings
- Used for moving loads on a rail



For your safety never exceed the indicated weight limit

Code	Load	Beam width	Minimum curve radius	Wheel size	Inner	Master
TC4409	1 ton	70-110 mm	1m	91 mm	1	1
TC4410	2 ton	90-125 mm	1.3 m	102 mm	1	1
TC4411	3 ton	100-150 mm	1.5 m	122 mm	1	1

Type of packaging: Box

PLATFORM HAND TRUCK

- Made of tubular steel
- Includes two solid 4" polypropylene wheels and 2 pneumatic tires of 10"
- Designed to handle with one hand.
- Varnished in blue color
- Steel plate on base and shaft
- Height: 1.23 m
- Base: 35.5 cm x 23 cm

Horizontal use



Load Capacity

385 kg vertical position
200 kg horizontal position

Vertical use: base at ground level for easy lifting and moving objects. Horizontal use: platform base to load higher volume items.

Code	Specification	Inner	Master
TC5332	2 positions	1	1

Type of packaging: Bulk

SOFT DRINK DELIVERY HAND TRUCK

- Made of tubular steel
- 8" solid tire
- Varnished in blue color
- Steel plate on base and shaft
- Height: 1.27 m
- Base: 27 cm x 42 cm



Load Capacity
300 kg

Inclined base to move items easier reclined to body.

Code	Specification	Inner	Master
TC3463	8" solid tire	1	1

Type of packaging: Bulk

WAREHOUSE HANDTRUCK

- Made of tubular steel
- 8" solid tire
- Varnished in blue color
- Steel plate on base and shaft
- Height: 1.40 m
- Base: 26 cm x 43 cm



Load Capacity
300 kg

Base at floor level ideal for easy lifting and moving objects.

Code	Specification	Inner	Master
TC3462	8" solid tire	1	1

Type of packaging: Bulk

SEMI-SQUARE HAND TRUCK

- Made of tubular steel
- Pneumatic tire 10"
- Designed to handle with one hand
- Varnished in blue color
- Steel plate on base and shaft
- Height: 1.30 m
- Base: 22 cm x 36 cm

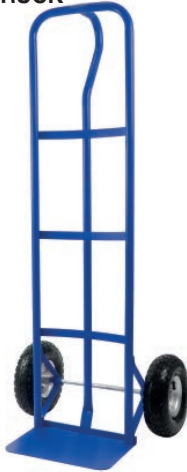

Load Capacity
300 kg

Base at floor level ideal for easy lifting and moving objects. Example: cardboard boxes.

Code	Specification	Inner	Master
TC0679	Pneumatic tire 10"	1	1

Type of packaging: Bulk

FOLDING HAND TRUCK



- Made of aluminium.
- Inserts in ABS and TPR
- Nylon wheels 5 1/2"
- Height 1 m
- Base: 28 x 38.5 cm



Load Capacity
90 kg

Code	Specification	Inner	Master
WF0724	Solid tire 5 1/2"	1	4

Type of packaging: Bulk

8" SOLID TIRE

- Ball bearings for a better resistance to load and constant use



Code	Measure	Inner	Master
TC2517	8"	4	6

Type of packaging: Bulk

PNEUMATIC TIRE

- Pneumatic tire with tube for better driving and comfort
- Ball bearings for a better resistance to load and constant use
- This tire is compatible with item TC0679



Code	Measure	Inner	Master
TC3571	8"	6	10
TC0880	10"	4	10

Type of packaging: Bulk

PNEUMATIC RIGID TOP PLATE CASTER

- Industrial use
- Workload: 30psi
- Working temperature range: -50° a 50°C
- Galvanized rim
- Ball bearing
- Indoor and outdoor use



Load Capacity
TC5321 - 140 kg
TC5322 - 150 kg

Code	Diameter wheel	Plate size	Inner	Master
TC5321	8" (203 mm)	115 mm x 115 mm	2	5
TC5322	10" (254 mm)	115 mm x 115 mm	2	5

Type of packaging: Bulk

PNEUMATIC SWIVEL TOP PLATE CASTER

- Industrial use
- Workload: 30psi
- Working temperature range: -50° a 50°C
- Galvanized rim
- Ball bearing
- Indoor and outdoor use



Load Capacity
TC5323 - 140 kg
TC5324 - 150 kg

Code	Diameter wheel	Plate size	Inner	Master
TC5323	8" (203 mm)	115 mm x 115 mm	2	5
TC5324	10" (254 mm)	115 mm x 115 mm	2	5

Type of packaging: Bulk

IRON SWIVEL TOP PLATE CASTER

- Industrial use
- For concrete smooth surfaces



Load Capacity
 TC5046 - 30 kg
 TC5047 - 35 kg
 TC5048 - 45 kg
 TC5049 - 70 kg

Code	Wheel diameter	Plate size	Inner	Master
TC5046	2" (50 mm)	59 mm x 59 mm	4	80
TC5047	2 1/2" (63 mm)	70 mm x 70 mm	4	48
TC5048	3" (75 mm)	70 mm x 70 mm	4	36
TC5049	4" (100 mm)	84 mm x 84 mm	2	24

Type of packaging: Bulk

IRON RIGID TOP PLATE CASTER

- Industrial use
- For concrete smooth surfaces



Load Capacity
 TC5042 - 30 kg
 TC5043 - 35 kg
 TC5044 - 45 kg
 TC5045 - 70 kg

Code	Wheel diameter	Plate size	Inner	Master
TC5042	2" (50 mm)	59 mm x 59 mm	4	80
TC5043	2 1/2" (63 mm)	70 mm x 70 mm	4	48
TC5044	3" (75 mm)	70 mm x 70 mm	4	36
TC5045	4" (100 mm)	84 mm x 84 mm	2	24

Type of packaging: Bulk

RUBBER SWIVEL TOP PLATE CASTER

- General Use
- For indoors and outdoors



Load Capacity
 TC5038 - 30 kg
 TC5039 - 35 kg
 TC5040 - 45 kg
 TC5041 - 55 kg

Code	Wheel diameter	Plate size	Inner	Master
TC5038	2" (50 mm)	59 mm x 59 mm	4	120
TC5039	2 1/2" (63 mm)	70 mm x 70 mm	4	80
TC5040	3" (75 mm)	70 mm x 70 mm	4	60
TC5041	4" (100 mm)	84 mm x 84 mm	2	32

Type of packaging: Bulk

RUBBER RIGID TOP PLATE CASTER

- General Use
- For indoors and outdoors



Load Capacity
 TC5034 - 30 kg
 TC5035 - 35 kg
 TC5036 - 45 kg
 TC5037 - 55 kg

Code	Diameter wheel	Plate size	Inner	Master
TC5034	2" (50 mm)	59 mm x 59 mm	4	120
TC5035	2 1/2" (63 mm)	70 mm x 70 mm	4	80
TC5036	3" (75 mm)	70 mm x 70 mm	4	60
TC5037	4" (100 mm)	84 mm x 84 mm	2	32

Type of packaging: Bulk

PVC SWIVEL TOP PLATE CASTER WITH BRAKE

- General Use
- For indoors and outdoors



Load Capacity
 TC5032 - 35 kg
 TC5033 - 45 kg

Code	Wheel diameter	Plate size	Inner	Master
TC5032	2" (50 mm)	50 mm x 50 mm	4	100
TC5033	3" (75 mm)	65 mm x 65 mm	4	60

Type of packaging: Bulk

PVC SWIVEL TOP PLATE CASTER

- General Use
- For indoors and outdoors



Load Capacity
 TC5030 - 35 kg
 TC5031 - 45 kg

Code	Wheel diameter	Plate size	Inner	Master
TC5030	2" (50 mm)	50 mm x 50 mm	4	120
TC5031	3" (75 mm)	65 mm x 65 mm	4	60

Type of packaging: Bulk

PVC RIGID TOP PLATE CASTER

- General Use
- For indoors and outdoors



Load Capacity
 TC5028 - 35 kg
 TC5029 - 45 kg

Code	Wheel diameter	Plate size	Inner	Master
TC5028	2" (50 mm)	65 mm x 65 mm	4	120
TC5029	3" (75 mm)	100 mm x 100 mm	4	60

Type of packaging: Bulk

RUBBER BALL CASTER

- General Use
- Pin with socket



Load Capacity
 50 kg

Code	Wheel diameter	Inner	Master
TC3864	1 1/2" (40 mm)	4	160
TC3865	2" (50 mm)	4	120

Type of packaging: Bulk

RUBBER SWIVEL TOP PLATE BALL CASTER

- General Use



Load Capacity
 TC5026 - 25 kg
 TC5027 - 25 kg
 TC3866 - 50 kg
 TC3867 - 50 kg

Code	Wheel diameter	Plate size	Inner	Master
TC5026	1 1/2" (40 mm)	38 mm x 38 mm	4	240
TC5027	2" (50 mm)	38 mm x 38 mm	4	160
TC3866	1 1/2" (40 mm)	38 mm x 38 mm	4	160
TC3867	2" (50 mm)	38 mm x 38 mm	4	120

Type of packaging: Bulk

NYLON TWIN-WHEEL CASTER

- General Use
- 20mm threaded pin



Load Capacity
 TC3090 - 20 kg
 TC3091 - 35 kg

Code	Wheel diameter	Inner	Master
TC3090	1 1/2" (40 mm)	4	240
TC3091	2" (50 mm)	4	160

Type of packaging: Bulk

NYLON TWIN-WHEEL SWIVEL TOP PLATE CASTER WITH BRAKE

- General Use



Load Capacity
 TC3088 - 20 kg
 TC3089 - 25 kg

Code	Wheel diameter	Plate size	Inner	Master
TC3088	1 1/2" (40 mm)	38 mm x 38 mm	4	240
TC3089	2" (50 mm)	38 mm x 38 mm	4	160

Type of packaging: Bulk

NYLON TWIN-WHEEL CASTER

- General Use



Load Capacity
 TC3086 - 20 kg
 TC3087 - 25 kg

Code	Wheel diameter	Plate size	Inner	Master
TC3086	1 1/2" (40 mm)	38 mm x 38 mm	4	240
TC3087	2" (50 mm)	38 mm x 38 mm	4	160

Type of packaging: Bulk

LATCH FOR TOWING 1.5 TON

- Drag capacity 1.5 tons (3,500 lb)
- Made with 4 mm thick steel

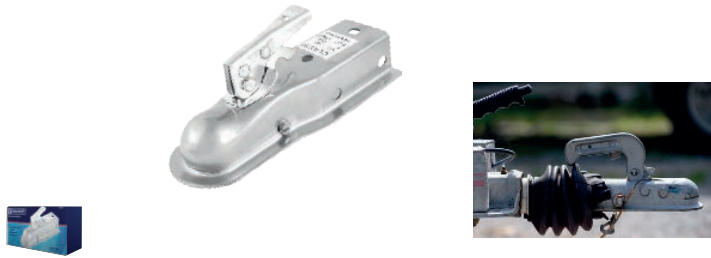

Code	Measure	Inner	Master
TC0870	2" x 2 1/2"	2	6

Type of packaging: Box

BALL FOR TOWING 1.5 TON

- Drag capacity 1.5 tons (3,500 lb)
- Screw diameter 3/4"
- Screw length 2 1/8"



Code	Ball measurement	Inner	Master
TC0869	2"	6	24

Type of packaging: Blister

BELT FOR RECOVERY OF VEHICLE

- Reinforced polyester strap
- Heavy duty drop-forged hooks with lock that prevents unhooking
- Supports a tension of 4.5 tons (10,000 lb)



Code	Width	Length	Inner	Master
TC0874	50 mm	4,6 m	1	12

Type of packaging: Blister

RATCHET TIE-DOWN

- It has 2 hardened metal hooks
- Varnished ratchet body
- Double gear for higher resistance
- Ideal for use in trailers and trucks

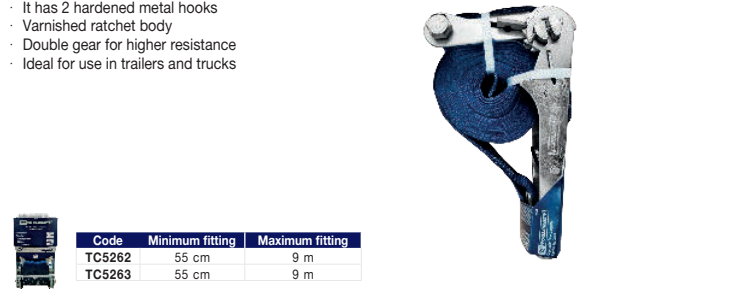

Code	Minimum fitting	Maximum fitting
TC5262	55 cm	9 m
TC5263	55 cm	9 m

Code	Measure	Workload	Max. load capacity	Inner	Master
TC5262	3" x 9m	1,800 kg	5,400 kg	1	2
TC5263	4" x 9m	2,000 kg	6,000 kg	1	2

Type of packaging: Cover

RATCHET TIE-DOWN

- They have 2 hardened metal hooks
- Varnished ratchet body
- Double gear for higher resistance

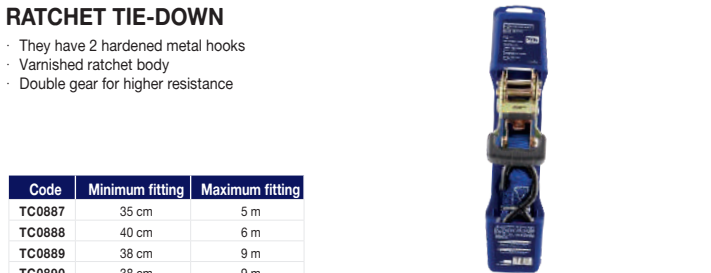

Code	Minimum fitting	Maximum fitting
TC0887	35 cm	5 m
TC0888	40 cm	6 m
TC0889	38 cm	9 m
TC0890	38 cm	9 m

Code	Measure	Workload	Maximum load capacity	Inner	Master
TC0887	1" x 5 m	247 kg	750 kg	6	24
TC0888	1 1/2" x 6 m	600 kg	1,800 kg	2	12
TC0889	2" x 9 m	1,000 kg	3,000 kg	2	8
TC0890	2" x 9 m	1,666 kg	5,000 kg	2	8

Type of packaging: Plastic case

RATCHET TIE-DOWN STRAPS 4-PIECE SET

- It adjusts from 35 cm to 5m
- Steel hooks with heat treatment covered in vinyl.
- Ratchet that facilitates its adjustment



Code	Measure	Workload	Maximum load capacity	Inner	Master
TC0882	1" x 5 m	165 kg	500 kg	2	8

Type of packaging: Plastic case

FASTENERS, 4-PIECE SET

- It adjusts from 26 cm to 12m
- Steel hooks with heat treatment covered in vinyl.
- Metal Buckles



Code	Measure	Workload	Maximum load capacity	Inner	Master
TC0881	1" x 2 m	100 kg	300 kg	2	10

Type of packaging: Plastic case

BUNGEE CORDS, 13-PIECE SET

- Ideal for securing baggage
- Highly resistant varnished metal S-hooks.
- Content:
 - 2 pieces of 3/8" x 10"
 - 3/8 pieces of 3/8" x 18"
 - 2 pieces of 2" x 3/8"
 - 2 pieces of 2" x 3/8"
 - 2 pieces of 2" x 3/8"
 - 2 pieces of 2" x 3/8"
 - 1 piece of 5/32" x 24"



Code	Load Capacity	Inner	Master
TC0883	20 kg	3	12

Type of packaging: Blister

CARPENTER PLANE



- Grooved base
- Steel fine grade blade



Code	Number	Cutting width	Inner	Master
WF1428	#4	2"	1	10
WF1429	#5	2"	1	10

Type of packaging: Box

TWIST WIRE CUP BRUSH

- Made of carbon steel
- For heavy duty and roughing in metals
- Useful on flat and irregular surfaces and large areas



! For your safety never surpass the number of rpm set

Code	Diameter	Gauge	Input	Wire length	RPM	Wire type	Inner	Master
*TC1277	2 1/2"	0.35 mm	5/8"	22 mm	12,500	Thin	6	60
TC5107	4"	0.35 mm	5/8"	22 mm	8,500	Thin	4	24
TC1278	5"	0.35 mm	5/8"	25 mm	6,500	Thin	4	24
TC1279	5"	0.35 mm	14 mm	25 mm	6,500	Thin	4	24
TC1301	5"	0.51 mm	5/8"	25 mm	6,500	Thick	4	24

Type of packaging: Blister

CRIMPED WIRE CUP BRUSH

- Made of carbon steel
- For light roughing and cleaning in metals
- Useful on flat and irregular surfaces and large areas



! For your safety never surpass the number of rpm set

Code	Diameter	Gauge	Input	Wire length	RPM	Wire type	Inner	Master
*TC1271	3"	0.30 mm	5/8"	22 mm	12,500	Thin	6	60
TC1273	4"	0.35 mm	5/8"	28 mm	6,500	Thin	4	40
TC1275	5"	0.35 mm	5/8"	32 mm	6,500	Thin	4	24
TC1276	5"	0.35 mm	14 mm	32 mm	6,500	Thin	4	24
TC1300	5"	0.51 mm	5/8"	32 mm	6,500	Thick	4	24

Type of packaging: Blister

TWIST WIRE WHEEL BRUSH

- Made of carbon steel
- For heavy duty and roughing in metals
- Useful in small spaces and small areas



! For your safety never surpass the number of rpm set

Code	Diameter	Gauge	Axis	Wire length	Thick-ness	RPM	Wire type	Inner	Master
TC1284	6"	0.35 mm	5/8"	32 mm	7/8"	9,000	Thin	4	24
TC1285	6"	0.51 mm	5/8"	32 mm	7/8"	9,000	Thick	6	24

Type of packaging: Blister

CRIMPED WIRE WHEEL BRUSH

- Made of carbon steel
- For light roughing and cleaning in metals
- Useful in small spaces and small areas
- TC1280 has 5 adapters:
1/2", 5/8", 3/4", 7/8" y 1"



! For your safety never surpass the number of rpm set

Code	Diameter	Gauge	Input	Wire length	Thickness	RPM	Inner	Master
TC1280	6"	0.35 mm	1 1/4"	30 mm	3/4"	6,000	6	24
TC1281	6"	0.35 mm	1/2"	30 mm	3/4"	6,000	6	24
TC1282	6"	0.35 mm	1/2"	30 mm	13/16"	6,000	6	24
TC1283	6"	0.35 mm	1/2"	30 mm	1/18"	6,000	6	24
TC1303	6"	0.20 mm	1/2"	30 mm	3/4"	6,000	6	24

Type of packaging: Blister

CRIMPED WIRE CUP BRUSH WITH SHANK

- Made of carbon steel
- To remove paint residue and polish in metal
- Useful on flat surfaces and large areas
- 1/4" stem



! For your safety never surpass the number of rpm set

Code	Diameter	Gauge	Wire type	Wire length	RPM	Inner	Master
TC1286	3/4"	0.30 mm	Thick	27 mm	4,500	6	60
TC1287	1"	0.30 mm	Thick	27 mm	4,500	6	60
TC1288	2"	0.30 mm	Thick	16 mm	4,500	6	60
TC1289	3"	0.30 mm	Thick	22 mm	4,500	6	60
TC1304	1 3/4"	0.20 mm	Thin	16 mm	4,500	6	60
TC1305	2 3/4"	0.20 mm	Thin	22 mm	4,500	6	60

Type of packaging: Blister

CRIMPED WIRE WHEEL BRUSH WITH SHANK

- Made of carbon steel
- To remove paint residue and polish in metal
- Useful in small spaces and small areas
- 1/4" stem



! For your safety never surpass the number of rpm set

Code	Diameter	Gauge	Wire type	Wire length	RPM	Inner	Master
TC1306	1 1/2"	0.30 mm	Thick	9 mm	6,000	6	60
TC1290	2"	0.30 mm	Thick	10 mm	4,500	6	60
TC1291	3"	0.30 mm	Thick	15 mm	4,500	6	60
TC1307	1 1/2"	0.20 mm	Thin	9 mm	6,000	6	60
TC1308	2"	0.20 mm	Thin	10 mm	4,500	6	60
TC1309	3"	0.20 mm	Thin	15 mm	4,500	6	60

Type of packaging: Blister

CRIMPED WIRE CUP BRUSH WITH SHANK

- Made of brass steel
- To remove paint residue and polish metal
- Useful on flat surfaces and large areas
- 1/4" stem



! For your safety never surpass the number of rpm set

Code	Diameter	Gauge	Wire type	Wire length	RPM	Inner	Master
TC5110	1 3/4"	0.30 mm	Thick	16 mm	4,500	6	60
TC5111	2 3/4"	0.30 mm	Thick	22 mm	4,500	6	60

Type of packaging: Blister

CRIMPED WIRE WHEEL BRUSH WITH SHANK

- Made of brass steel
- To remove paint residue and polish metal
- Useful in small spaces and small areas
- 1/4" stem



! For your safety never surpass the number of rpm set

Code	Diameter	Gauge	Wire type	Wire length	RPM	Inner	Master
TC5108	2"	0.30 mm	Thick	9.5 mm	4,500	6	60
TC5109	3"	0.30 mm	Thick	16 mm	4,500	6	60

Type of packaging: Blister

BRUSHES | WIRE BRUSHES

3-PIECE WIRE BRUSH SET

- Made of carbon steel
- To remove paint residue, roughing job
- 5/8" arbor



⚠ For your safety never surpass the number of rpm set

Contents	Diameter	Bristle Length
Twist wire wheel brush	3"	22 mm
Grinding Brush	4"	-
Crimped Wire Cup Brush	4"	22 mm

Code	Gauge	Input	RPM	Inner	Master
TC5113	0.30 mm	Thick	12,500	3	50

Type of packaging: Blister

4-PIECE WIRE BRUSH SET

- Made of carbon steel
- To remove paint residue
- 1/4" stem



⚠ For your safety never surpass the number of rpm set

Contents	Diameter	Bristle Length
Flap Wheel Wire Brush	3"	16 mm
Grinding Brush	3"	-
Crimped Wire Cup Brush	2"	16 mm
Crimped Wire Cup Brush	3/4"	28 mm

Code	Gauge	Wire type	RPM	Inner	Master
TC5112	0.30 mm	Thick	4,500	3	40

Type of packaging: Blister

WIRE BRUSH SQUARE HANDLE

- Ideal for scraping and cleaning ferrous materials
- High resistant plastic handle
- High-carbon steel smooth and tempered wire
- Gauge: 0.35 mm



Code	Rows	Exposed sow	Inner	Master
TC3267	6 x 19 rows (114 brushes)	30 mm	6	36
TC3268	9 x 20 rows (180 brushes)	30 mm	6	36

Type of packaging: Bulk

WIRE BRUSH 64 STAINLESS STEEL BRUSHES

- For cleaning stainless steel, aluminum or special alloys without polluting
- High resistant plastic handle
- Stainless steel wire
- Gauge: 0.35 mm



Code	Rows	Exposed sow	Inner	Master
TC4670	4 x 16 rows	28 mm	6	36

Type of packaging: Bulk

WIRE BRUSH CURVED HANDLE 64 BRUSHES

- Ideal for scraping and cleaning ferrous materials
- High resistant plastic handle
- High-carbon steel smooth and tempered wire
- Gauge: 0.35 mm



Code	Rows	Exposed sow	Inner	Master
TC3264	4 x 16 rows	30 mm	6	36

Type of packaging: Bulk

ROW STRAIGHT HANDLE WIRE WITH SCRAPER 51 BRUSHES

- Ideal for scraping and cleaning ferrous materials
- High resistant plastic handle
- High-carbon steel smooth and tempered wire
- Gauge: 0.35 mm



Code	Rows	Exposed sow	Inner	Master
TC3266	3 x 17 rows	30 mm	6	36

Type of packaging: Bulk

ROW STRAIGHT HANDLE WIRE 51 BRUSHES

- Ideal for scraping and cleaning ferrous materials
- High resistant plastic handle
- High-carbon steel smooth and tempered wire
- Gauge: 0.35 mm



Code	Rows	Exposed sow	Inner	Master
TC3265	3 x 17 rows	30 mm	6	36

Type of packaging: Bulk

CURVED HANDLE WIRE HAND BRUSH

- For cleaning soft metals and objects of irregular shape
- Polypropylene handle
- Brass wavy wire
- Gauge: 0.32 mm



Code	Characteristics	Exposed sow	Inner	Master
TC4671	Spark-proof	30 mm	6	72

Type of packaging: Bulk

4-PIECE WIRE BRUSH SET

- Made of brass plated steel
- To remove paint residue
- 1/4" stem



⚠ For your safety never surpass the number of rpm set

Contents	Diameter	Bristle Length
Flap Wheel Wire Brush	3"	16 mm
Crimped Wire Cup Brush	2"	16 mm
Crimped Wire Cup Brush	1"	28 mm
Crimped Curved Hand Brush	-	30 mm

Code	Gauge	Wire type	RPM	Inner	Master
TC5114	0.30 mm	Thick	4,500	5	50

Type of packaging: Blister

3 MINI BRUSH SET

- For cleaning hard to reach areas and doing detailed work
- Polypropylene handle
- Includes:
 - Brush with brass bristle, gauge 0.15 mm
 - Brush with nylon bristle, gauge 0.4 mm
 - Brush with stainless steel bristle gauge 0.15 mm



Code	Characteristics	Exposed sow	Inner	Master
WF0086	20 brushes	13 mm	6	72

Type of packaging: Blister

Wolfox





WHEELBARROWS

SEMI-DEEP WHEELBARROW, 4.5 CUBIC FEET (65 LITERS)

- Reinforced frame, ergonomic design
- Die cast in 1 single
- Electrostatic painting



Code	Characteristics	Shell caliber	Inner	Master
TC0601	16" x 4" reinforced pneumatic tire	22	1	1
TC0602	16" x 4" Pneumatic block tire	22	1	1
TC3188	14" x 3" solid tire	22	1	1
TC0609	Shell 4.5 cubic feet	22	1	1

Type of packaging: Bulk

DEEP WHEELBARROW, 5 CUBIC FEET (70 LITERS)

- Reinforced frame, ergonomic design
- Die cut one single piece
- Electrostatic painting



Code	Characteristics	Shell caliber	Inner	Master
*TC0828	16" x 4" reinforced pneumatic tire	22	1	1
TC0829	16" x 4" Pneumatic block tire	22	1	1
TC3189	14" x 3" solid tire	22	1	1
TC5238	16" x 4" pneumatic block tire	22	1	1
TC0604	Concha 5 pies cúbicos	22	1	1

Type of packaging: Bulk

EXTRA DEEP WHEELBARROW, 6 CUBIC FEET (100 LITERS)

- Reinforced frame, ergonomic design
- Die cast in 1 single
- Electrostatic painting



Code	Characteristics	Shell caliber	Inner	Master
TC0603	16" x 4" reinforced pneumatic tire	20	1	1
TC0610	Shell 6 cubic feet	20	1	1

Type of packaging: Bulk

EXTRA DEEP WHEELBARROW, 6 CUBIC FEET (100 LITERS)

- Reinforced frame, ergonomic design
- Die cast in 1 single piece
- Electrostatic painting



Code	Wheel rim	Shell thickness	Inner	Master
TC5336	16" x 4" reinforced pneumatic tire	3.9 mm	1	1
TC4533	Plastic shell 6 cubic feet	3.9 mm	1	1

Type of packaging: Bulk

WHEELBARROWS | WHEELBARROW TIRES

SEMI-DEEP WHEELBARROW, 4.5 CUBIC FEET (65 LITERS)

- Reinforced frame, ergonomic design
- Die cast in 1 single
- Electrostatic painting



Code	Characteristics	Shell caliber	Inner	Master
TC0601M	16" x 4" reinforced pneumatic tire	22	1	1
TC0602M	16" x 4" Pneumatic block tire	22	1	1
TC3188M	14" x 3" solid tire	22	1	1
TC0609	Shell 4.5 cubic feet	22	1	1

Type of packaging: Bulk

DEEP WHEELBARROW, 5 CUBIC FEET (70 LITERS)

- Reinforced frame, ergonomic design
- Die cut one single piece
- Electrostatic painting



Code	Characteristics	Shell caliber	Inner	Master
TC0828M	16" x 4" reinforced pneumatic tire	22	1	1
TC0829M	16" x 4" Pneumatic block tire	22	1	1
TC3189M	14" x 3" solid tire	22	1	1
TC0604	Shell 5 cubic feet	22	1	1

Type of packaging: Bulk

EXTRA DEEP WHEELBARROW, 6 CUBIC FIT (100 LITERS)

- Reinforced frame, ergonomic design
- Die cast in 1 single
- Electrostatic painting



Code	Characteristics	Shell caliber	Inner	Master
TC0603M	16" x 4" reinforced pneumatic tire	20	1	1
TC0610	Shell 6 cubic feet	20	1	1

Type of packaging: Bulk

PLASTIC EXTRA DEEP WHEELBARROW, 6 CUBIC FIT 6 CUBIC FEET (100 LITERS)

- Reinforced frame, ergonomic design
- Die cast in 1 single piece
- Electrostatic painting



Code	Wheel rim	Shell thickness	Inner	Master
TC4815M	16" x 4" reinforced pneumatic tire	3.9 mm	1	1
TC4533	Plastic shell 6 cubic feet	3.9 mm	1	1

Type of packaging: Bulk

SEMI-DEEP WHEELBARROW, 4 CUBIC FEET (58 LITERS)

- Reinforced frame ergonomic design
- Die cast in 1 single piece
- Electrostatic painting



Wolfax

Code	Wheel rim	Shell caliber	Inner	Master
WF9779	14" x 3" reinforced pneumatic tire	24	1	1

Type of packaging: Bulk

DEEP WHEELBARROW, 5 CUBIC FEET (70 LITERS)

- Reinforced frame ergonomic design
- Die cast in 1 single piece
- Electrostatic painting



Wolfax

Code	Wheel rim	Shell caliber	Inner	Master
*WF9708	14" x 3" reinforced pneumatic tire	24	1	1

Type of packaging: Bulk

REPLACEMENT PARTS



Code	Description	Inner	Master
TC0611	Tubular replacement handle for wheelbarrow	1	5
TC0612	Tubular wheelbarrow holder set (2)	1	1
TC0613	Brace set	1	10
TC0614	Leg brace set (1)	1	1
TC0616	Axle bracket set for wheelbarrow (2)	1	1
TC0617	Axle for wheelbarrow (1)	1	50
TC0618	Bearing set (2)	10	100
TC0620	Screw set	6	6
TC2867	Rim for wheelbarrow	2	7

Type of packaging: Box, bag (TC0618, TC0620) and bulk (TC2867)

WOOD HANDLE AND ACCESSORIES



Code	Description	Inner	Master
TC3963	Screw set (replaces TC0620)	1	1
TC3964	Wooden handle	1	1
TC3965	Plastic wedge	1	1
TC3966	Front protector	1	1

Type of packaging: Box, bag (TC3963)

16" X 4" FLAT FREE TIRE FOR WHEELBARROW

- Made of high resistance rubber
- Solid tire with rim
- Loading capacity: 198 kg (435 lb)



Code	Description	Inner	Master
TC4059	Solid tire and rim	1	1

Type of packaging: Box

16" x 4" COMPLETE PNEUMATIC TIRES FOR WHEELBARROW

- Tires made of high quality rubber
- Rolled of great resistance



TC0402



TC0605

Code	Description	Inner	Master
TC0402	Reinforced tire, camera and rim	2	5
TC0605	Light tire, camera and rim	2	20

Type of packaging: Bulk

COMPLETE SOLID TIRE FOR WHEELBARROW 14" X 3"

- Made of high resistant rubber
- Load capacity: 200 kg (440 lb)



Code	Description	Inner	Master
TC2869	Solid tire and rim	1	1

Type of packaging: Bulk

16" X 4" PNEUMATIC TIRES FOR WHEELBARROW

- Tires made of high quality rubber
- Rolled of great resistance



TC0606



TC0607



TC0608

Code	Description	Inner	Master
*TC0606	Reinforced tire and camera	2	20
TC0607	Light tire and camera	2	20
TC5535	Reinforced tire	4	20
TC0608	Spare camera	10	100

Type of packaging: Bulk, Bag (TC0608)

TOOLCRAFT DISPLAY RACK FOR WHEELBARROWS

- Structure manufactured with ptr
- Electrostatic paint blue color
- Art: digital printing on vinyl white labeled on styrene
- Measures:
 - Height: 200 cm
 - Width: 82 cm
 - Bottom: 70 cm



Code	Capacity	Inner	Master
TC5438	3 wheelbarrows	1	1

* Does not include product

REPLACEMENT TIRES



WF9781



WF9848



WF9782



WF9783

Code	Description	Inner	Master
WF9783	Full reinforced tire, 14 "x 3"	1	5
WF9848	Full solid rim 13 "x 3"	1	1
WF9782	Tire and reinforced camera 14 "x 3"	2	20
WF0782	Reinforced tire 14 "x 3"	4	20
WF9781	Spare camera	10	100

Type of packaging: Bulk, Box (TC9848)

SOLDERING IRON | TAPES

SOLDERING IRON

- For electrical and electronic work
- Can weld a variety of metals
- 1.8 m cable
- Copper tip
- Nylon handle
- Includes: 2 tips and base

Work cycle:
10 min of use x 15 min
of rest



TC5521



TC5522



TC5523



Specifications	
Voltage	120 V
Frequency	60 Hz

More soldering irons
in section **fulgore**
Page 208



Code	Power	Maximum temperature	Tip diameter	Inner	Master
TC5521	30 W	320°C	3.6 mm	4	24
TC5522	45 W	400°C	4 mm	4	24
TC5523	60 W	450°C	5 mm	4	24

Type of packaging: Blister

SOLDERING IRON WITH ACCESSORIES

- For electrical and electronic work
- Can weld a variety of metals
- Copper tip
- Light use
- Includes:
1 spare tip
1 welding paste
1 welding
1 screwdriver



Specifications	
Voltage	120 V
Frequency	60 Hz
Power	30W

More soldering irons
in section **fulgore**
Page 208



Code	Power	Tip diameter	Inner	Master
WF1681	30 W	3 mm	8	48

Type of packaging: Blister

SOLDERING IRON

- For electrical and electronic work
- Can weld a variety of metals
- Copper tip
- Light use



Specifications	
Voltage	120 V
Frequency	60 Hz
Power	30W

More soldering irons
in section **fulgore**
Page 208



Code	Power	Tip diameter	Inner	Master
WF9894	30 W	3 mm	8	48

Type of packaging: Blister

THREAD SEAL TAPE FOR GAS LINE

- Made of resistant PTFE, 0.075 mm thick
- Temperature range of -190 °C ~ +230 °C
- Recommended for gas
- Density: 1 g / cm³
- Elongation: 50%
- Dispatch box with 10 thread seal tapes



Dispatcher box

Code	Size	Inner	Master
TC1078	1/2" x 6.60 m	10	240

Type of packaging: Dispatch box

THREAD SEAL TAPE, GENERAL USE

- Made of resistant PTFE, 0.075 mm thick
- Temperature range of -190 °C ~ +230 °C
- Density: 0.3 g/cm³
- Elongation: 25%
- Dispatch box with 10 thread seal tapes



Dispatcher box

Code	Size	Inner	Master
TC1072	1/2" x 6.60 m	10	240
TC1073	3/4" x 6.60 m	10	240
TC1074	1/2" x 13.20 m	10	1200
*TC1075	3/4" x 13.20 m	10	1200
TC5085	1" x 13.20 m	10	240

Type of packaging: Dispatch box

SET OF 2 THREAD SEAL TAPES GENERAL USE

- Made of resistant 0.075 mm PTFE
- Resists temperatures of: -190 °C ~ +230 °C
- Density: 0.3 g / cm³
- Elongation: 25%



Code	Capacity	Inner	Master
TC1465	1/2" x 6.60 m	12	72

Type of packaging: Blister

LEAK COVER TAPE

- Made with butyl glue
- It can be used on all types of surfaces (concrete, metal, wood, etc.)
- Thick: 1 mm
- Temperature range: -40°C - 90°C
- Elongation: 70%



Code	Size	Color	Inner	Master
TC5381	4" x 1 m	Black	6	144
TC5380	4" x 10 m	Black	1	12

Type of packing: TC5381 carton - TC5380 bulk or roll

LEAK COVER TAPE

- Made with bituminous glue
- It can be used on all types of surfaces (cement, metal, wood, etc.)
- Thick: 1 mm
- Temperature range: 5 °C - 40 °C
- Elongation: 100%



Code	Size	Color	Inner	Master
WF0728	4" x 10 m	Black	1	12

Type of packaging: Bulk or roll



THREAD SEAL TAPE, GENERAL USE

- Tape thickness: 0.075 mm
- Resists temperatures of: -230°C ~ +260°C
- Density: 0.25 g / cm³
- Elongation: 20%
- Dispatch box with 10 thread seal tapes



Dispatcher box

Code	Size	Inner	Master
WF2250	1/2" x 6 m	100	1000
WF9790	3/4" x 6 m	100	1000

Type of packaging: Dispatch box

ALUMINUM FOIL TAPE

- Made of 0.9 mm thick aluminum foil
- Hot melt adhesive
- For HVAC ducts



Code	Size	Inner	Master
TC1076	50 mm x 45 m	3	36

Type of packaging: Bulk

DUCT TAPE

- 0.18 mm thick tape made of 80% cotton and 20% polyethylene coated polyester
- Hot melt adhesive



Code	Size	Color	Inner	Master
*TC1064	48 mm x 9 m	Gray	24	48
TC1062	48 mm x 27 m	Gray	12	48
TC1063	48 mm x 45 m	Gray	6	48
TC5100	48 mm x 9 m	Black	24	48
TC5101	48 mm x 45 m	Black	6	48

Type of packaging: Bulk

MASKING TAPE

- Made with semi-corrugated paper
- 0.14 mm thick
- Rubber Adhesive



Code	Size	Inner	Master
TC1069	1/2" x 50 m	12	144
TC1065	3/4" x 50 m	12	96
*TC1066	1" x 50 m	12	72
TC1067	1 1/2" x 50 m	12	48
TC1068	2" x 50 m	12	48

Type of packaging: Bulk

TAPE DISPENSER

- Plastic gun grip tape dispenser with blade
- Includes 2 transparent tapes of 50 m each one



Code	Size	Inner	Master
TC1098	48 mm x 50 m	2	20

Type of packaging: Blister

TAN PACKING TAPE

- Made of polypropylene
- 0.045 mm thick
- Acrylic adhesive



Code	Size	Color	Inner	Master
TC3877	48 mm x 35 m	Cinnamon	6	36
*TC1070	48 mm x 50 m	Cinnamon	6	36
TC3879	48 mm x 150 m	Cinnamon	6	36
TC3878	48 mm x 35 m	Transparent	6	36
*TC1071	48 mm x 50 m	Transparent	6	36
TC3880	48 mm x 150 m	Transparent	12	36

Type of packaging: Bulk

INDUSTRIAL THREAD SEAL TAPE

- Made of resistant PTFE, 0.1 mm thick
- Temperature range of -190 °C ~ + 230 °C
- Recommended for gas
- Density: 0.95 g / cm³
- Elongation: 50%



Code	Size	Inner	Master
TC5092	1/2" x 6.60 m	10	240
TC5086	3/4" x 6.60 m	10	240

Type of packaging: Bulk

BARRICADE TAPES

- Made of polyethylene 3 "wide
- Thick: 0.04 mm
- Length: 1000' / 300 m
- Great resistance
- Legend printed in Spanish and English



Code	Characteristics	Inner	Master
TC0994	"Precaución" / "Caution"	6	12
TC0995	"Peligro" / "Danger"	6	12
TC0996	"Prohibido el paso" / "No trespassing"	6	12

Type of packaging: Bulk

BARRICADE TAPE

- Made of 3" width poly
- Thick: 0.03 mm
- Length: 300' / 90 m
- Legend printed in Spanish and English

Wolf



Code	Characteristics	Inner	Master
WF0725	"Precaución" / "Caution"	6	36

Type of packaging: Bulk

SELF-STICK SAFETY STRIPE TAPE

- Made of polyethylene
- Thick: 0.130 mm
- Length: 30 m
- Acrylic adhesive



Code	Color	Inner	Master
TC5098	Yellow / Black	6	36
TC5099	Red / white	6	36

Type of packaging: Bulk

NON-SLIP TAPE

- Made of polyurethane with 0.75 mm thick
- Large acrylic adhesive with pressure sensibility
- Weather resistant
- High friction texture
- Special for steps and bath tubs



Code	Size	Color	Inner	Master
TC5102	25 mm x 5 m	Black	6	72
TC1077	50 mm x 5 m	Black	6	72
TC5269	50 mm x 5 m	Transparent	6	72
TC5270	50 mm x 5 m	Black / Yellow	6	72

Type of packaging: Bulk

POLYPROPYLENE ROPE

- Made of polypropylene
- 100% virgin
- Blue rope yarn
- High resistance
- Reel presentation for safety handling



Max. tension

TC1154	200 kg
TC1155	400 kg
TC1156	700 kg
TC1157	1,050 kg
TC1158	1,850 kg
TC5069	3,476 kg

Code	Diameter	m x kg approx.	Approx. weight with without reel	Inner	Master
TC1154	3/16" (4 mm)	112	15 kg 14.0 kg	1	1
TC1155	1/4" (6 mm)	55	25 kg 23.3 kg	1	1
TC1156	5/16" (8 mm)	35	25 kg 23.3 kg	1	1
TC1157	3/8" (10 mm)	20	25 kg 23.3 kg	1	1
TC1158	1/2" (13 mm)	12	32 kg 30.2 kg	1	1
TC5069	3/4" (19 mm)	6	32 kg 30.2 kg	1	1

Type of packaging: Reel

WHITE TWINE YARN

- White color
- Polypropylene
- 100% virgin



Code	Gauge	Roll weight	Inner	Master
*TC1159	2.2 g/m	0.9 kg	6	24
TC3883	2.2 g/m	4.4 kg	1	4
TC3884	4 g/m	4.4 kg	1	4

Type of packaging: Roll

TILE CUTTERS

MASON LINE REEL

- Multi-strand polypropylene thread
- Load resistance: 6.5 kg
- Gauge 18



Code	Color	Length	Inner	Master
TC3868	White	65 m	10	100
TC3869	Yellow	65 m	10	100
TC3870	Orange	65 m	10	100
TC3871	Pink	65 m	10	100
TC3872	Green	65 m	10	100
TC3873	White	165 m	10	100

Type of packaging: Bag

PLUMMET

- Made of bronze
- Rectified tip of tempered steel



Spare tip included

Code	Weight	Inner	Master
TC0383	227 g	3	60
TC0384	340 g	3	40
TC0385	454 g	3	40
TC0386	680 g	3	20

Type of packaging: Blister

ZAMAC PLUMMET WITH CENTER

Wolfox

- Made with zamac



Code	Number	Weight	Inner	Master
WF1690	1	200 g	6	36
WF1691	2	310 g	6	36
WF1692	3	340 g	6	36
WF1693	4	675 g	4	24

Type of packaging: Bulk

HEAVY DUTY TILE CUTTER

- Wear-resistant chrome plated steel bars
- High precision metal powder bushings
- Includes 3 blades: 8 mm, 10 mm, 18 mm
- Titanium-coated tungsten blades
- Base and steel crank



Spare part

Code	Size	Inner	Master
TC4216	17" (430 mm)	1	2
TC4217	22" (550 mm)	1	2
TC3881	26" (660 mm)	1	2
Replacement blades			
TC4299	8 mm (stem and 1 blade)	3	200
TC4298	10 mm (stem and 1 blade)	3	200
TC3882	18 mm (stem and 2 blades)	3	200

Type of packaging: Box, case (TC4217), shrink (TC4299, TC4298, TC3882)

TILE CUTTER WITH BALL BEARINGS

- Wear-resistant chrome plated steel bars
- Titanium coated tungsten blade, 1,000 m quality
- Anti-impact stops
- Graduated metallic ruler and conveyor



Spare blade

Code	Size	Inner	Master
TC1768	16" (400 mm)	1	3
TC4213	20" (500 mm)	1	3
TC1769	24" (600 mm)	1	3
TC4214	27" (700 mm)	1	3
Replacement blades			
TC0699	16 mm (2 blades)	3	200
TC1770	22 mm (2 blades)	4	240

Type of packaging: Box (TC1768, TC4213, TC1769, TC4214), shrink (TC0699 TC1770)

PROFESSIONAL TILE CUTTER

- Wear-resistant chrome plated steel bars
- High precision metal powder bushings
- Titanium coated tungsten blade, 1,000 m quality
- Graduated metallic ruler and conveyor

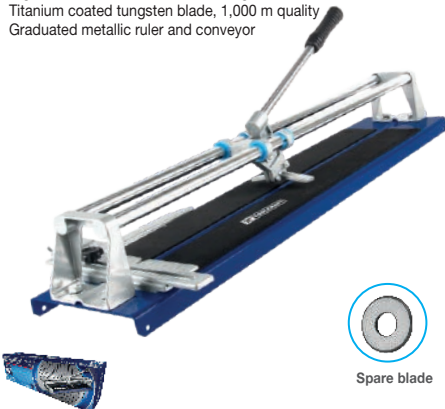

Spare blade

Code	Size	Inner	Master
TC0231	17" (430 mm)	1	4
TC4215	20" (500 mm)	1	4
TC0380	24" (600 mm)	1	4
Replacement blades			
TC0232	15 mm (2 blades)	3	200
TC0699	16 mm (2 blades)	3	200

Type of packaging: Box (TC0231, TC4215, TC0380), shrink (TC0232 TC0699)

4-IN-1 TILE CUTTER

- Wear-resistant chrome plated steel bars
- High precision bushings
- Tungsten carbide blades
- Blades for circular cutting inside tiles
- Steel base and handle
- Heavy duty



Spare blade

Code	Size	Inner	Master
WF0144	16" (400 mm)	1	4
*WF0145	24" (600 mm)	1	4
Spare blade			
TC0232	15 mm (2 blades)	3	200

Type of packaging: Box (WF0144, WF0145), shrink (TC0232)

TILE CUTTER

Wolfox

- Wear-resistant chrome plated bars
- High precision bushings
- Tungsten carbide blades
- Steel base and handle

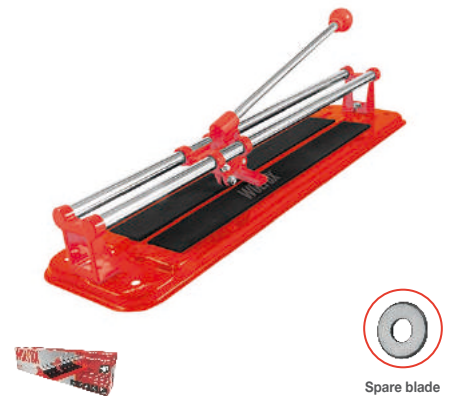

Spare blade

Code	Size	Inner	Master
WF0142	16" (400 mm)	1	6
WF0143	24" (600 mm)	1	3
Spare blade			
TC0232	15 mm (2 blades)	3	200

Type of packaging: Box (WF0142, WF0143), shrink (TC0232)

TUBULAR BOLT CUTTER

- CR Steel Knife - Molybdenum
- Hardness 60 HRC
- Handles designed for greater leverage with the same effort



Code	Length	Diameter bolt cut	Inner	Master
TC1610	12"	3/16"	2	18
TC0038	14"	1/4"	2	20
TC0039	18"	3/8"	2	20
TC0040	24"	7/16"	2	10
TC0041	30"	1/2"	1	6
TC0042	36"	9/16"	1	5

Type of packaging: Box

SPARE BLADE FOR BOLT CUTTER

- Material: Chrome Molybdenum
- Cutting edge hardness: 60 HRC



Code	Measure	Diameter bolt cut	Inner	Master
TC1611	12" (305 mm)	3/16"	1	6
TC0043	14" (350 mm)	1/4"	1	6
TC0044	18" (450 mm)	3/8"	1	6
TC0045	24" (600 mm)	7/16"	1	6
TC0046	30" (750 mm)	1/2"	1	6
TC0047	36" (900 mm)	9/16"	1	4

Type of packaging: Box

TUBULAR BOLT CUTTER

- T8 steel blade
- Grip handle



Code	Length	Diameter bolt cut	Inner	Master
WF1623	18"	3/8"	2	16
WF1624	24"	7/16"	2	8
WF1625	30"	1/2"	1	4
WF9811	36"	9/16"	1	4

Type of packaging: Bulk



PLASTIC PIPE CUTTER

- Stainless steel blade
- Cuts pvc, cpvc, ppr, pex, poly
- Aluminum body
- Soft and progressive cut
- Ratchet system



Code	Maximum opening	Inner	Master
TC3326	1 5/8"	6	48

Type of packaging: Blister

2" STEEL PIPE CUTTER

- Steel blade
- To cut pipes made of steel, copper, bronze, aluminum and conduit tube
- Cutting capacity 1/2" to 2"



Code	Maximum opening	Inner	Master
TC4612	2"	1	9

Type of packaging: Box

PIPE CUTTER 2"

- Steel blade
- For cutting brass, aluminium-covered plastic tube and conduit tube
- Cutting capacity 1/8" to 2"
- With burrs remover
- Includes spare blade



Spare blade

Code	Maximum opening	Inner	Master
TC0348	2"	1	48
Spare part			
TC0349	2 blades of 3 mm	5	500

Type of packaging: Blister (TC0348), shrink (TC0349)

1-1/8" PIPE CUTTER

- Steel blade
- For cutting brass, aluminized plastic tube and conduit tube
- Cutting capacity 1/8" to 1 1/8"
- With burrs remover
- Includes spare blade



Spare blade

Code	Maximum opening	Inner	Master
TC0341	1 1/8"	2	60
Spare part			
TC0349	2 blades of 3 mm	5	500

Type of packaging: Blister (TC0341), shrink (TC0349)

1- 1/8" MINI PIPE CUTTER

- Steel blade
- To cut copper, bronze and aluminum pipes
- Cutting capacity 1/8" to 1 1/8"
- For areas hard to reach



Code	Maximum opening	Inner	Master
TC4613	1 1/8"	3	72

Type of packaging: Blister (TC4613)

1-1/8" PIPE CUTTER

- Steel blade
- Cutting capacity from 1/8" to 1 1/8"
- With burrs remover



Spare blade

Code	Maximum opening	Inner	Master
WF1801	1 1/8"	4	60
Spare blade			
WF0601	Blade set / 2 pcs	10	500

Type of packaging: Blister (WF1801), shrink (WF0601)

GLASS CUTTER | BRICK TROWELS

PIPE CUTTER AND FLARING TOOL SET

- *Pipe cutter**
 - Forged steel blade
 - To cut copper, bronze and aluminum pipes
 - Cutting capacity 1/8" to 1 1/8"
 - Aluminum alloy body
 - With burrs remover
 - Includes spare blade
- *Flaring tool**
 - Made of steel
 - Measures from 3/16" to 5/8"
 - Double clamps for quick release



Code	Countersunk	Inner	Master
TC4614	3/16" a 5/8"	1	12

Type of packaging: Plastic case

PROFESSIONAL FLARING TOOL

- Made of forged steel
- Double clamps for quick release
- For soft materials like brass, aluminum and copper
- For 45° flaring



Capacity
3/16"
1/4"
5/16"
3/8"
7/16"
1/2"
5/8"

Code	Countersunk	Inner	Master
TC0344	3/16" a 5/8"	1	24

Type of packaging: Blister

FLARING TOOL

- Made of steel
- Double clamps for quick release
- For soft materials like brass, aluminum and copper
- For 45° flaring



Capacity
3/16"
1/4"
5/16"
3/8"
7/16"
1/2"
5/8"

Code	Countersunk	Inner	Master
TC1079	3/16" a 5/8"	2	25

Type of packaging: Blister

6-BLADE GLASS CUTTER

- Wooden handle
- German type
- Rotating blade: 6.5 mm



6 tungsten carbide blades

Code	Characteristics	Inner	Master
TC3117	2 cutting slots	4	240

Type of packaging: Blister

1-BLADE GLASS CUTTER

- Made of zinc
- Rotating blade: 6.5 mm



Tungsten carbide blade

Code	Characteristics	Inner	Master
TC0306	3 ranuras	4	240

Type of packaging: Blister

GUADALAJARA PATTERN BRICK TROWEL

- Made of hardened steel
- Forged in one piece
- Polished finish
- Metal cap bonding pin with epoxy resin
- Hardness: 48 - 52 HRC



Code	Size	Inner	Master
TC4222	9"	4	48

Type of packaging: Bulk

PHILADELPHIA PATTERN BRICK TROWEL

- Made of hardened steel
- Forged in one piece
- Polished finish
- Metal cap bonding pin with epoxy resin
- Hardness: 48 - 52 HRC



Code	Size	Inner	Master
TC4223	6"	6	48
TC4219	9"	6	48
TC4220	10"	6	48
TC4221	11"	4	48

Type of packaging: Bulk

MARGIN BRICK TROWEL

Wolfox

- Made of carbon steel
- Electrowelded
- Wooden handle with cap
- Hardness 45 to 52 HRC



Code	Size	Inner	Master
WF0141	9"	6	48

Type of packaging: Bulk

GUADALAJARA PATTERN BRICK TROWEL

Wolfox

- Made of carbon steel
- Electrowelded
- Wooden handle with cap
- Hardness 45 to 52 HRC



Code	Size	Inner	Master
WF1929	9"	6	36

Type of packaging: Bulk

PHILADELPHIA PATTERN BRICK TROWEL

Wolfox

- Made of carbon steel
- Electrowelded
- Wooden handle with cap
- Hardness 45 to 52 HRC



Code	Size	Inner	Master
WF9812	6"	6	72
WF1909	9"	6	48
WF1910	10"	6	48
WF1911	11"	6	36

Type of packaging: Bulk

MÉRIDA PATTERN BRICK TROWEL

Wolfox

- Made of carbon steel
- Electrowelded
- Wooden handle with cap
- Hardness 45 to 52 HRC



Code	Size	Inner	Master
WF0138	7"	6	72
WF0139	8"	6	72
WF0140	9"	6	48

Type of packaging: Bulk

FINISHING TROWEL WITH WOOD HANDLE

6 RIVETS

- Aluminum blade
- Measures: 11" x 5"
- Polished finish
- Professional use



Code	Edge	Number of rivets	Inner	Master
TC4254	Smooth	6	6	48
TC4260	Grooved	6	6	48
TC4257	Square grooved	6	6	48

Type of packaging: Bulk

FINISHING TROWEL WITH WOOD HANDLE

10 RIVETS

- Aluminum blade
- Measures: 11" x 5"
- Polished finish
- Professional use



Code	Edge	Number of rivets	Inner	Master
TC4253	Smooth	10	6	48
TC4259	Grooved	10	6	48
TC4256	Square grooved	10	6	48

Type of packaging: Bulk

TROWEL WITH PLASTIC HANDLE

- Aluminum blade
- Measures: 11" x 5"
- Polished finish



Code	Edge	Number of rivets	Inner	Master
TC4255	Smooth	6	6	48
TC4261	Grooved	6	6	48
TC4258	Square grooved	6	6	48

Type of packaging: Bulk

SKIMMER

- High resistance wooden handle
- Creates a groove on the sidewalk



Code	Capacity	Inner	Master
TC3124	Skimmer / Aluminum Blade	6	36

Type of packaging: Bulk

RUBBER GROUT FLOAT

- Wooden handle
- Aluminum blade
- Ideal for nozzle clean finish



Code	Size	Thickness	Finishing	Inner	Master
TC0256	4" x 9"	3/4"	Rough	10	50
TC0359	4" x 12"	1/2"	Rough	5	50

Type of packaging: Bulk

GUM RUBBER GROUT FLOAT

- Wooden handle
- Aluminum blade
- Special for tile grouting, polishing and cement surfacing.



Code	Size	Thickness	Finishing	Inner	Master
TC4262	4" x 9"	5/8"	Smooth	6	50

Type of packaging: Bulk

TURNER

- High resistance wooden handle
- Creates edge with smooth finish on sidewalks, slab, stairs, etc



Code	Capacity	Inner	Master
TC3125	Turner / Aluminum foil	6	36

Type of packaging: Bulk

GUM RUBBER GROUT FLOAT

- Wooden handle
- Aluminum blade
- Special for paste and cement smooth finish.



Code	Size	Thickness	Finishing	Inner	Master
TC4263	4" x 9"	5/8"	Thin	6	50

Type of packaging: Bulk

RUBBER GROUT FLOAT

- Plastic handle
- Aluminum blade
- Ideal for nozzle clean finish



Code	Size	Thickness	Finishing	Inner	Master
WF0035	4" x 9"	3/4"	Rough	10	50

Type of packaging: Bulk

Wolfax

GUM RUBBER GROUT FLOAT

- Plastic handle
- Aluminum blade
- Ideal for nozzle clean finish



Code	Size	Thickness	Finishing	Inner	Master
WF1697	4" x 9"	7 / 16"	Smooth	6	36

Type of packaging: Bulk

SOCKETS

6-POINT, STANDARD AND METRIC SOCKET, 1/4" DRIVE

- Made of Cr-V steel
- Finishing: polished mirror



Code	Size	Inner	Master
Standard			
TC3628	3/16"	6	72
TC3629	1/4"	6	72
TC3630	5/16"	6	72
TC3631	3/8"	6	72
TC3632	7/16"	6	72
TC3633	1/2"	6	72
Millimetric			
TC3634	6 mm	6	72
TC3635	8 mm	6	72
TC3636	9 mm	6	72
TC3637	10 mm	6	72
TC3638	11 mm	6	72
TC3639	12 mm	6	72
TC3640	13 mm	6	72

Type of packaging: Plastic hanger

6-POINT, STANDARD AND METRIC SOCKET, 3/8" DRIVE

- Made of Cr-V steel
- Finishing: polished mirror



Code	Size	Inner	Master
Standard			
TC3641	1/4"	6	72
TC3642	5/16"	6	72
TC3643	3/8"	6	72
TC3644	7/16"	6	72
TC3645	1/2"	6	72
TC3646	9/16"	6	72
TC3647	5/8"	6	72
TC3648	11/16"	6	72
TC3649	3/4"	6	72
TC3650	13/16"	6	72
TC3651	7/8"	6	72
Millimetric			
TC3652	6 mm	6	72
TC3653	7 mm	6	72
TC3654	8 mm	6	72
TC3655	9 mm	6	72
TC3656	10 mm	6	72
TC3657	11 mm	6	72
TC3658	12 mm	6	72
TC3659	13 mm	6	72
TC3660	14 mm	6	72
TC3661	15 mm	6	72
TC3662	16 mm	6	72
TC3663	17 mm	6	72
TC3664	18 mm	6	72
TC3665	19 mm	6	72

Type of packaging: Plastic hanger

6-POINT, LONG STANDARD AND METRIC SOCKET, 3/8" DRIVE

- Made of Cr-V steel
- Finishing: polished mirror



Code	Size	Inner	Master
Standard			
TC3666	3/8"	6	72
TC3667	7/16"	6	72
TC3668	1/2"	6	72
TC3669	9/16"	6	72
TC3670	5/8"	6	72
TC3671	11/16"	6	72
TC3672	3/4"	6	72
TC3673	13/16"	6	72
TC3674	7/8"	6	72
Millimetric			
TC3675	10 mm	6	72
TC3676	11 mm	6	72
TC3677	12 mm	6	72
TC3678	13 mm	6	72
TC3679	14 mm	6	72
TC3680	15 mm	6	72
TC3681	16 mm	6	72
TC3682	17 mm	6	72
TC3683	18 mm	6	72
TC3684	19 mm	6	72

Type of packaging: Plastic hanger

6-POINT, STANDARD AND METRIC SOCKET, 1/2" DRIVE

- Made of Cr-V steel
- Finishing: polished mirror



Code	Size	Inner	Master
Standard			
TC3711	3/8"	6	72
TC3712	7/16"	6	72
TC3713	1/2"	6	72
TC3714	9/16"	6	72
TC3715	5/8"	6	72
TC3716	11/16"	6	72
TC3717	3/4"	6	72
TC3718	13/16"	6	72
TC3719	7/8"	6	72
TC3720	15/16"	6	72
TC3721	1"	6	72
Millimetric			
TC3722	10 mm	6	72
TC3723	11 mm	6	72
TC3724	12 mm	6	72
TC3725	13 mm	6	72
TC3726	14 mm	6	72
TC3727	15 mm	6	72
TC3728	16 mm	6	72
TC3729	17 mm	6	72
TC3730	18 mm	6	72
TC3731	19 mm	6	72

Type of packaging: Plastic hanger

6-POINT, LONG STANDARD AND METRIC SOCKET, 1/2" DRIVE

- Made of Cr-V steel
- Finishing: polished mirror



Code	Size	Inner	Master
Standard			
TC3732	3/8"	6	72
TC3733	7/16"	6	72
TC3734	1/2"	6	72
TC3735	9/16"	6	72
TC3736	5/8"	6	72
TC3737	11/16"	6	72
TC3738	3/4"	6	72
TC3739	13/16"	6	72
TC3740	7/8"	6	72
TC3741	15/16"	6	72
TC3742	1"	6	72
Millimetric			
TC3743	10 mm	6	72
TC3744	11 mm	6	72
TC3745	12 mm	6	72
TC3746	13 mm	6	72
TC3747	14 mm	6	72
TC3748	15 mm	6	72
TC3749	16 mm	6	72
TC3750	17 mm	6	72
TC3751	18 mm	6	72
TC3752	19 mm	6	72

Type of packaging: Plastic hanger

6-POINT, SPARK PLUG SOCKET, 3/8" DRIVE

- Made of Cr-V steel
- Finishing: polished mirror



Code	Size	Inner	Master
TC3786	5/8"	6	72
TC3787	13/16"	6	72

Type of packaging: Plastic hanger

6-POINT, SPARK PLUG SOCKET, 1/2" DRIVE

- Made of Cr-V steel
- Finishing: polished mirror
- 6 point
- With neoprene insert that facilitates the placement of the spark plugs



Code	Size	Inner	Master
TC3788	5/8"	6	72
TC3789	13/16"	6	72

Type of packaging: Plastic hanger

12-POINT LONG STANDARD AND METRIC SOCKET, 1/2" DRIVE

- Made of Cr-V steel
- Finishing: polished mirror



Code	Size	Inner	Master
Standard			
TC3685	1/4"	6	72
TC3686	5/16"	6	72
TC3687	3/8"	6	72
TC3688	7/16"	6	72
TC3689	1/2"	6	72
TC3690	9/16"	6	72
TC3691	5/8"	6	72
TC3692	11/16"	6	72
TC3693	3/4"	6	72
TC3694	13/16"	6	72
TC3695	7/8"	6	72
TC3696	15/16"	6	72
TC3697	1"	6	72
Millimeter			
TC3698	7 mm	6	72
TC3699	8 mm	6	72
TC3700	9 mm	6	72
TC3701	10 mm	6	72
TC3702	11 mm	6	72
TC3703	12 mm	6	72
TC3704	13 mm	6	72
TC3705	14 mm	6	72
TC3706	15 mm	6	72
TC3707	16 mm	6	72
TC3708	17 mm	6	72
TC3709	18 mm	6	72
TC3710	19 mm	6	72

Type of packaging: Plastic hanger

12-POINT, STANDARD AND METRIC SOCKET, 1/2" DRIVE

- Made of Cr-V steel
- Finishing: polished mirror



Code	Size	Inner	Master
Standard			
TC3753	5/16"	6	72
TC3754	3/8"	6	72
TC3755	7/16"	6	72
TC3756	1/2"	6	72
TC3757	9/16"	6	72
TC3758	5/8"	6	72
TC3759	11/16"	6	72
TC3760	3/4"	6	72
TC3761	13/16"	6	72
TC3762	7/8"	6	72
TC3763	15/16"	6	72
TC3764	1"	6	72
Millimeter			
TC3765	9 mm	6	72
TC3766	10 mm	6	72
TC3767	11 mm	6	72
TC3768	12 mm	6	72
TC3769	13 mm	6	72
TC3770	14 mm	6	72
TC3771	15 mm	6	72
TC3772	16 mm	6	72
TC3773	17 mm	6	72
TC3774	18 mm	6	72
TC3775	19 mm	6	72
TC3776	20 mm	6	72

Type of packaging: Plastic hanger

12-POINT LONG STANDARD AND METRIC SOCKET, 1/2" DRIVE

- Made of Cr-V steel
- Finishing: polished mirror



Code	Size	Inner	Master
Standard			
TC3777	1/2"	6	72
TC3778	9/16"	6	72
TC3779	5/8"	6	72
TC3780	11/16"	6	72
TC3781	3/4"	6	72
TC3782	13/16"	6	72
TC3783	7/8"	6	72
TC3784	15/16"	6	72
TC3785	1"	6	72

Type of packaging: Plastic hanger

TORX BIT SOCKET, 3/8" DRIVE

- Made of Cr-V steel
- Finishing: polished mirror



Code	Size	Inner	Master
TC3790	T20	6	72
TC3791	T25	6	72
TC3792	T30	6	72
TC3793	T40	6	72
TC3794	T45	6	72
TC3795	T50	6	72
TC3796	T55	6	72

Type of packaging: Plastic hanger

TORX BIT SOCKET, 1/2" DRIVE

- Made of Cr-V steel
- Finishing: polished mirror



Code	Size	Inner	Master
TC3797	T20	6	72
TC3798	T25	6	72
TC3799	T30	6	72
TC3800	T40	6	72
TC3801	T45	6	72
TC3802	T50	6	72
TC3803	T55	6	72

Type of packaging: Plastic hanger

SOCKET ADAPTER

- Made of Cr-V steel
- Finishing: polished mirror



Code	Size	Inner	Master
TC3804	From 1/4" to 3/8"	6	72
TC3805	From 3/8" to 1/4"	6	72
TC3807	From 3/8" to 1/2"	6	72
TC3806	From 1/2" to 3/8"	6	72

Type of packaging: Plastic hanger

SOCKETS | RATCHETS

UNIVERSAL JOINT

- Made of Cr-V steel
- Finishing: polished mirror
- Allows angled turns up to 65°
- Special for hard to reach places



1/4" 3/8" 1/2"

Code	Drive	Inner	Master
TC3808	1/4"	6	72
TC3809	3/8"	6	72
TC3810	1/2"	6	72

Type of packaging: Bulk

3/8" EXTENSION

- Made of Cr-V steel
- Finishing: polished mirror



3/8"

Code	Length	Inner	Master
TC3811	3"	6	72
TC3812	6"	6	72
TC3813	10"	6	72

Type of packaging: Bulk

BREAKER BAR

- Made of Cr-V steel
- Frame manufactured in chrome molybdenum steel
- Knurled handle



3/8" 1/2"

Code	Drive	Length	Inner	Master
TC3814	3/8"	7 1/2"	2	72
TC3815	1/2"	17"	2	36

Type of packaging: Bulk

SPEED HANDLE 1/2" DRIVE

- Made in Cr-v steel
- Chrome finish

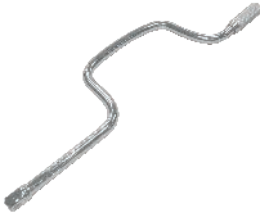

1/2"

Code	Drive	Length	Inner	Master
TC4500	1/2"	16"	2	24

Type of packaging: Bulk

"L" HANDLE, 1/2" DRIVE

- Made in Cr-v steel
- Chrome finish



1/2"

Code	Drive	Length	Inner	Master
TC4499	1/2"	10"	4	24

Type of packaging: Bulk

SLIDING "T" HANDLE, 1/2" DRIVE

- Made in Cr-v steel
- Chrome finish



1/2"

Code	Drive	Length	Inner	Master
TC4501	1/2"	10"	6	24

Type of packaging: Bulk

TEAR DROP FLEX HEAD RATCHET

- Made of Cr-V steel
- Chrome finish
- Chromium molybdenum gear
- 45 teeth gear system
- Knurled handle



1/4" 3/8" 1/2"

Code	Drive	Length	Inner	Master
TC3816	3/8"	8"	2	36
TC4502	1/4"	6"	2	36
TC3817	1/2"	10"	2	36

Type of packaging: Plastic hanger

TRIPLE DRIVE RATCHET, 1/4", 3/8" AND 1/2" DRIVE

- Made of Cr-V steel
- Chrome finish
- Chromium molybdenum gear
- 45 teeth gear system
- Knurled handle



1/2"

Code	Length	Inner	Master
TC4503	7"	3	36

Type of packaging: Plastic hanger

ROUND HEAD RATCHET

- Made of Cr-V steel
- Chrome finish
- Chromium molybdenum gear
- 45 teeth gear system
- Knurled handle



3/8" 1/2"

Code	Drive	Length	Inner	Master
TC3818	3/8"	8"	2	36
TC3819	1/2"	10"	2	36

Type of packaging: Plastic hanger

TEARDROPFLEXHEAD RATCHET

- Forged in carbon steel
- Chrome finish corrosion resistant
- Reversible
- Knurled handle
- Gear system of 24 teeth



1/4" 3/8" 1/2"

Code	Drive	Length	Inner	Master
WF5305	1/4"	6"	2	48
WF5306	3/8"	8"	2	36
WF5304	1/2"	10"	2	36

Type of packaging: Blister

Wolfox

ROUND HEAD RATCHET

- Forged in carbon steel
- Chrome finish corrosion resistant
- Reversible
- Knurled handle
- Gear system of 24 teeth



1/4" 3/8" 1/2"

Code	Drive	Length	Gear	Inner	Master
WF5302	1/4"	6"	43 teeth	4	48
WF5303	3/8"	8"	39 teeth	4	48
WF5301	1/2"	10"	45 teeth	4	36

Type of packaging: Blister

Wolfox

CLICK-TYPE TORQUE WRENCH

- Made of steel
- Drive: 1/2"
- Torsion capacity:
 - 10- 150 - 10 ft/lb
 - 1.4 - 20.7 m- kg
- Click-type system that reduces the chance of error
- Knurled handle
- 24 teeth per ratchet



Code	Torque range	Inner	Master
TC3365	1/2" 10-150 ft/lb	1	12

Type of packaging: Plastic case

DEFLECTING BEAM TORQUE WRENCH

- Made of Cr-V steel
- Drive: 1/2"
- Torsion capacity:
 - 0 - 140 ft/lb
 - 0 - 19.35 m-kg
- With dual measurement scale that allows to apply torque in both directions



Code	Torque range	Inner	Master
TC3364	1/2" 0-140 ft/lb	1	6

Type of packaging: Card

SOCKET SET WITH RATCHET 3/8" DRIVE

- Made of Cr-V steel
- 12 point short sockets
- Chrome finish



Contents	
Standard	Metric
3/8"	10 mm
7/16"	11 mm
1/2"	12 mm
9/16"	13 mm
5/8"	14 mm
11/16"	15 mm
3/4"	16 mm
13/16"	17 mm
7/8"	
1"	
Professional ratchet Teardrop 7"	
1 articulated handle 7 1/2"	
1 extension of 3"	
1 extension of 8"	
1 metallic box	
Total: 26 Pieces	

Code	Characteristics	Inner	Master
TC0260	Set of 26 pieces	1	8

Type of packaging: Metallic Case

METRIC SOCKET SET 1/2" DRIVE

- Made of Cr-V steel
- Short sockets of 12 points
- Chrome finish



Contents	
Standard	Metric
3/8"	10 mm
7/16"	11 mm
1/2"	12 mm
9/16"	13 mm
5/8"	14 mm
11/16"	15 mm
3/4"	16 mm
13/16"	17 mm
7/8"	
1"	
Professional ratchet Teardrop 9"	
1 articulated handle 17"	
1 universal knot of 1/2"	
1 extension of 5"	
1 extension of 10"	
1 metallic box	
Total: 26 pieces	

Code	Characteristics	Inner	Master
TC0261	Set of 26 pieces	1	4

Type of packaging: Metallic Case

SOCKET SET WITH RATCHET 3/8" DRIVE

- Sockets and ratchet made of Cr-V Steel
- The cam-blocking system removes damaged screws
- 6-point short sockets
- Chrome finish



3/8"

Contents	
Standard	Metric
1/4"	9 mm
5/16"	10 mm
3/8"	11 mm
7/16"	12 mm
1/2"	13 mm
9/16"	14 mm
5/8"	15 mm
11/16"	17 mm
3/4"	19 mm
1 Ratchet of 3/8"	
1 Case	
Total: 20 Pieces	

Code	Characteristics	Inner	Master
TC1429	Set of 20 pieces	1	12

Type of packaging: Plastic case

SOCKET SET WITH RATCHET 1/2" DRIVE

- Socket and ratchet made of Cr-V steel
- The cam-blocking system removes damaged screws
- 6-point short sockets
- Chrome finish



1/2"

Contents	
Standard	Metric
3/8"	10 mm
7/16"	11 mm
1/2"	13 mm
9/16"	14 mm
5/8"	15 mm
11/16"	17 mm
3/4"	19 mm
13/16"	21 mm
7/8"	22 mm
1 Ratchet of 1/2"	
1 Case	
Total: 20 Pieces	

Code	Characteristics	Inner	Master
TC1428	Set of 20 pieces	1	8

Type of packaging: Plastic case

STANDARD SOCKET SET 1/2" DRIVE

- Made of Cr-V steel
- 12 point short sockets



1/2"

Contents
Standard
3/8"
5/8"
7/16"
11/16"
1/2"
3/4"
9/16"
13/16"

Code	Characteristics	Inner	Master
TC0375	8 pieces	2	20

Type of packaging: Plastic case

METRIC SOCKET SET 1/2" DRIVE

- Made of Cr-V steel
- 12 point short sockets



1/2"

Contents
10 mm
11 mm
12 mm
13 mm
14 mm
15 mm
17 mm
19 mm

Code	Characteristics	Inner	Master
TC0376	8 pieces	2	20

Type of packaging: Plastic case

SOCKETS | SCREWDRIVERS

Wolfox

25-PIECE BIT AND SOCKET SET

- Made of steel carbon steel
- 1 1/2" reversible ratchet
- 1 1/2" x 10" extension
- 1 1/2" x 5" extension
- 1 1/2" x 16 x 1/2" bit brace
- 1 1/2" disc
- 1 1/2" and 5/8" spark plug socket
- 18 standard sockets of 6 points
- 1 plastic case



Code	Characteristics	Inner	Master
WF2025	25 pieces	1	5

Type of packaging: Case

Wolfox

40-PIECE BIT AND SOCKET SET

- Made of carbon steel
- 1 3/8" reversible ratchet
- 1 3/8" x 3" extension bar
- 1 3/8" a 1/4" adapter
- 1 3/8" long socket
- 1 plastic disc for 3/8" socket adjustment
- 1 screwdriver for 1/4" socket
- 3 1/4" 8-point standards sockets
- 12 1/4" 6-point standard sockets
- 3 3/8" 6-point standard sockets
- 3 3/8" 6-point sockets
- 12 1/4" 6-point sockets
- 1 plastic case



Code	Characteristics	Inner	Master
WF2040	40 pieces	2	12

Type of packaging: Case

STANDARD SOCKET SET 3/8" DRIVE

- Made of Cr-V steel
- 12 point short sockets



Contents
3/8"
5/8"
7/16"
11/16"
1/2"
3/4"
9/16"
13/16"

Code	Characteristics	Inner	Master
TC0373	8 pieces	2	20

Type of packaging: Plastic case

METRIC SOCKET SET 3/8" DRIVE

- Made of Cr-V steel
- 12 point short sockets



Contents
10 mm
11 mm
12 mm
13 mm
14 mm
15 mm
17 mm
19 mm

Code	Characteristics	Inner	Master
TC0374	8 pieces	2	20

Type of packaging: Plastic case

STANDARD SOCKET SET 1/2" DRIVE

- Made of steel carbon steel
- Chrome finish corrosion resistant
- 6 point socket



Contents
1/2"
9/16"
5/8"
11/16"
3/4"
13/16"
7/8"
15/16"

Code	Characteristics	Inner	Master
WF2019	8 pieces	6	18

Type of packaging: Rack

METRIC SOCKET SET 1/2" DRIVE

- Made in carbon steel
- Chrome finish corrosion resistant
- 6 point socket



Contents
13 mm
14 mm
15 mm
18 mm
19 mm
21 mm
22 mm
24 mm

Code	Characteristics	Inner	Master
WF2029	8 pieces	6	18

Type of packaging: Rack

STANDARD SOCKET SET 3/8" DRIVE

- Made in carbon steel
- Chrome finish corrosion resistant
- 6 point socket



Contents
3/8"
7/16"
1/2"
9/16"
5/8"
11/16"
3/4"
13/16"
7/8"

Code	Characteristics	Inner	Master
WF2010	9 pieces	6	24

Type of packaging: Rack

METRIC SOCKET SET 3/8" DRIVE

- Made of steel carbon steel
- Chrome finish corrosion resistant
- 6 point socket



Contents
10 mm
11 mm
12 mm
13 mm
14 mm
15 mm
16 mm
17 mm
18 mm

Code	Characteristics	Inner	Master
WF2009	9 pieces	6	24

Type of packaging: Rack

SCREWDRIVER SET TYPE RATCHET AND TIPS

- Sockets Made of carbon steel
- The cam-blocking system removes damaged screws
- Tips manufactured in Cr-V
- Included:
 - 1 adapter of 9 sockets
 - 1 handle with ratchet
 - 1 case



Sockets	Screwdriver tips Allen	Screwdriver tips Torx
5 mm		T10
6 mm		T15
7 mm	2 mm	T20
8 mm	2.5 mm	T25
9 mm	3 mm	T30
10 mm	4 mm	T35
11 mm	5.5 mm	
12 mm	6 mm	
13 mm		



Screwdriver tips Phillips	Screwdriver tips Pozidriv	Slotted Demolition Screwdriver tips
PH0	PZ0	SL4
PH1	PZ1	SL5
PH2	PZ2	SL6
PH3	PZ3	SL7

Code	Characteristics	Inner	Master
TC1430	32 pieces set	2	10

Type of packaging: Blister

PRECISION SCREWDRIVER SET

- Cr-V steel points
- For use in electronics, jewelry, etc.

- ▬ Flat:
 - 3.00 mm, 2.40 mm y 1.40 mm

- ⊕ Phillips:
 - #1, #0 y #00



Code	Characteristics	Inner	Master
TC0738	6 pieces	6	48

Type of packaging: Case

ACETATE SCREWDRIVERS

- Magnetized tip
- Cr-V steel bar



FLAT

PHILLIPS

CABINET

Code	Size	Flat	Inner	Master
TC4206	3/16" x 4"		6	36
TC4204	1/4" x 4"		6	36
TC4203	1/4" x 6"		6	36
TC4205	5/16" x 6"		6	36
Phillips				
TC4200	1/8" x 4"		6	36
TC4201	1/8" x 6"		6	36
TC4198	3/16" x 3"		6	36
TC4197	3/16" x 6"		6	36
TC4199	3/16" x 8"		6	36
TC4196	1/4" x 4"		6	36
TC4195	1/4" x 6"		6	36
TC4202	1/4" x 8"		6	36
Cabinet				
TC4207	1/8" x 4"		6	36
TC4210	1/8" x 6"		6	36
TC4211	1/8" x 8"		6	36
TC4208	3/16" x 4"		6	36
TC4209	3/16" x 6"		6	36
TC4212	3/16" x 8"		6	36

Type of packaging: Plastic hanger

SLOTTED SCREWDRIVER DUAL-MATERIAL HANDLE

- Magnetized tip
- Cr-V steel bar



Code	Size	Inner	Master
TC0701	3/16" x 4"	6	48
TC0702	3/16" x 5	6	48
TC0703	1/4" x 4"	6	48
TC0704	1/4" x 6"	6	48
TC0705	5/16" x 6"	6	48
TC0706	5/16" x 8"	6	48
TC0708	3/8" x 8"	6	48

Type of packaging: Plastic hanger

PHILLIPS SCREWDRIVER DUAL-MATERIAL HANDLE

- Magnetized tip
- Cr-V steel bar



Code	Size	Inner	Master
TC0709	1/8" x 4"	6	48
TC0710	1/8" x 6"	6	48
TC0711	1/8" x 8"	6	48
TC0712	3/16" x 3"	6	48
TC0713	3/16" x 4"	6	48
TC0714	3/16" x 6"	6	48
TC0715	3/16" x 8"	6	48
TC0716	1/4" x 4"	6	48
TC0717	1/4" x 6"	6	48
TC0719	5/16" x 6"	6	48

Type of packaging: Plastic hanger

CABINET SCREWDRIVER DUAL-MATERIAL HANDLE

- Magnetized tip
- Cr-V steel bar



Code	Size	Inner	Master
TC0721	1/8" x 3"	6	48
TC0722	1/8" x 4"	6	48
TC0723	1/8" x 6"	6	48
TC0724	1/8" x 8"	6	48
TC0726	3/16" x 4"	6	48
TC0727	3/16" x 6"	6	48
TC0728	3/16" x 8"	6	48

Type of packaging: Plastic hanger

TORX SCREWDRIVER DUAL-MATERIAL HANDLE

- Magnetized tip
- Cr-V steel bar



Code	Size	Inner	Master
TC0731	T10	6	48
TC0732	T15	6	48
TC0733	T20	6	48
TC0734	T25	6	48
TC0735	T27	6	48
TC0736	T30	6	48

Type of packaging: Plastic hanger

BOX SCREWDRIVER DUAL-MATERIAL HANDLE

- Cr-V steel bar



Code	Size	Inner	Master
TC1824	3/16" x 3"	6	36
TC1825	1/4" x 3"	6	36
TC1826	5/16" x 3	6	36
TC1827	3/8" x 3"	6	36
TC1828	7/16" x 3	6	36
TC1829	1/2" x 3	6	36

Type of packaging: Plastic hanger

TORX SCREWDRIVER SET DUAL-MATERIAL HANDLE

- Magnetized tip
- Cr-V steel bar
- Contains: T-10, T-15, T-20, T-25, T-27, T-30
- Length: 4" (100 mm)



Code	Capacity	Inner	Master
TC1425	6 pieces	3	48

Type of packaging: Blister

SLOTTED DEMOLITION SCREWDRIVERS, DUAL-MATERIAL HANDLE

- Magnetized tips
- Cr-V steel bar
- Hexagonal bar
- One-piece body that runs through the handle



Code	Size	Inner	Master
TC2683	1/4" X 4"	6	36
TC2684	1/4" X 6"	6	36
TC2685	3/16" X 3"	6	36
TC2686	3/8" X 10"	6	36
TC2687	3/8" X 8"	6	36
TC2688	5/16" X 6"	6	36
TC2689	5/16" X 8"	6	36

Type of packaging: Plastic hanger

PHILLIPS DEMOLITION SCREWDRIVERS DUAL-MATERIAL HANDLE

- Magnetized tips
- Steel bar Cr-V steel
- Hexagonal bar
- One-piece body that runs through the handle



Code	Size	Inner	Master
TC2677	3/16" x 3"	6	36
TC2678	1/4" x 4"	6	36
TC2679	1/4" x 6"	6	36
TC2680	5/16" x 6"	6	36
TC2681	5/16" x 8"	6	36
TC2682	3/8" x 8"	6	36

Type of packaging: Plastic hanger

DEMOLITION SCREWDRIVER SET DUAL-MATERIAL HANDLE

- Magnetized tips
- One-piece Cr-V steel bar
- Tip with treatment that increases resistance and prevents slips
- Impact head type nut to increase torque force

- Standard: 3/16" x 4"; 3/16" x 6" and 5/16" x 6"
- ⊕ Phillips: #1 x 3" and #2 x 4"



Code	Characteristics	Inner	Master
TC0239	5 pieces	3	12

Type of packaging: Blister

SCREWDRIVERS

SCREWDRIVER SET DUAL-MATERIAL HANDLE

- Magnetized tip
- Cr-V steel bar
- Standard:
 - 3/16" x 3"; 3/16" x 4"
 - 3/16" x 6"

- Cabinet:
 - 3/16" x 4"

- Phillips:
 - 1/4" x 4"; 1/4" x 6"

- Torx:
 - T-10 x 4"; T-15 x 4"



Code	Characteristics	Inner	Master
TC1426	8 pieces	3	24

Type of packaging: Blister

SCREWDRIVER SET DUAL-MATERIAL HANDLE

- Magnetized tip
- Cr-V steel bar
- Includes screwdrivers holder
- Phillips: 3/16" x 3"; 1/4" x 4"

Standard: 1/4" x 6"; 3/16" x 4"

Cabinet: 3/16" x 4"



Code	Characteristics	Inner	Master
TC3304	5 pieces	4	48

Type of packaging: Blister

SCREWDRIVER SET FOR ELECTRONICS

- Magnetic peaked tips
- Cr-V steel bar
- Dual-material handle
- Plastic cover to prevent electric shock
- Maximum capacity 1,000V

Standard:

- 3/32" x 3"; 1/8" x 4";
- 7/32" x 5" y 1/4" x 6"

- Phillips:
 - #0 x 3"; #1 x 3" y
 - #2 x 4"

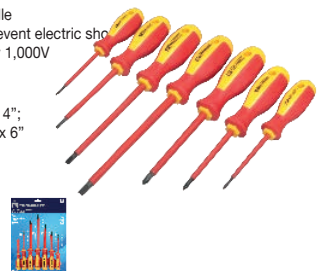

Code	Characteristics	Inner	Master
TC0240	7 pieces	2	24

Type of packaging: Blister

SLOTTED SCREWDRIVER



- Magnetized tip
- Steel bar



Code	Size	Inner	Master
WF2102	3/16" X 4"	6	96
WF2104	1/4" X 4"	6	96
WF2106	1/4" X 6"	6	96

Type of packaging: Bulk

PHILLIPS SCREWDRIVER



- Magnetized tip
- Steel bar



Code	Size	Inner	Master
WF2113	3/16" x 3"	6	96
WF2116	3/16" x 6"	6	96
WF2118	3/16" x 8"	6	96
WF2124	1/4" x 4"	6	96
WF2126	1/4" x 6"	6	96
WF2128	1/4" x 8"	6	96

Type of packaging: Bulk

CABINET SCREWDRIVER



- Magnetized tip
- Steel bar



Code	Size	Inner	Master
WF2134	1/8" x 4"	6	96
WF2136	1/8" x 6"	6	96
WF2138	1/8" x 8"	6	96
WF2144	3/16" x 4"	6	96
WF2146	3/16" x 6"	6	96
WF2148	3/16" x 8"	6	96

Type of packaging: Bulk

IMPACT SCREWDRIVER SET



- Made of Cr-V steel
- Acrylic acetate handle
- Square Bar

Flat:

- " x 3/16"
- 1/4" x 4"
- 1/4" x 6"
- 5/16" x 8"

- Square Bar
- Phillips:
 - 3/16" x 3"
 - 1/4" x 4"
 - 1/4" x 6"



Code	Characteristics	Inner	Master
WF2187	7 pieces	4	24

Type of packaging: Blister

SCREWDRIVER SET DUAL-MATERIAL HANDLE



- Dual-material handle
- Steel bar
- Magnetized tip

WF2184 - 4 pieces
 Phillips: 3/16" x 6", 3/16" x 4"
 Flat: 1/4" x 4"
 Cabinet: 1/4" x 4"

WF2186 - 6 pieces
 Phillips: 3/16" x 3", 3/16" x 6", 1/4" x 4"
 Flat: 1/4" x 4", 1/4" x 6"
 Cabinet: 1/4" x 4"



Code	Characteristics	Inner	Master
WF2184	4 pieces	3	48
WF2186	6 pieces	3	24

Type of packaging: Blister

PVC SCREWDRIVER SET



- Steel bar
- WF9350 - 4 pieces
- Phillips:
 - 3/16" x 4", 1/4" x 4"
- Flat:
 - 3/16" x 4", 1/4" x 4"
- WF9351 - 6 pieces
- Phillips:
 - 3/164" x 1/4", 4" x 1/4"
- Flat:
 - 3/16" x 3", 3/16" x 6",
 - 1/4" x 4", 1/4" x 6"



Code	Characteristics	Inner	Master
WF9350	4 pieces	6	36
WF9351	6 pieces	6	24

Type of packaging: Blister

PRECISION SCREWDRIVERS



- Carbon steel tips
- For use in electronics, jewelry, etc.

Flat:

- 1.4 mm. 2 mm. 2.4 mm,
- 3 mm

- Phillips:
 - #1, #0



Code	Characteristics	Inner	Master
WF2190	6 pieces	6	60

Type of packaging: Case

RATCHET SCREWDRIVER SET, 53 PIECES



- Carbon steel tips
- Grip handle



Code	Characteristics	Inner	Master
WF1687	53 pieces	3	24

Type of packaging: Blister

RATCHET SCREWDRIVER SET, 34 PIECES



- Carbon steel tips
- Grip handle



Code	Characteristics	Inner	Master
WF1686	34 pieces	3	24

Type of packaging: Blister

RATCHET SCREWDRIVER SET, 6 TIPS

- Carbon steel tips
- Grip handle
- Contents
- Flat tips: 1/4 and 3/16
- Phillips tip: # 3 and # 1
- Pozi-driv tip: Pz2 and Pz1



Code	Characteristics	Inner	Master
WF1685	6 points	6	72

Type of packaging: Blister

1" BIT SET, 29 PIECES

- Made of S2 steel
- To be used with electric drill or screwdriver
- Drive: 1/4"
- Plastic organizer included



Code	Characteristics	Inner	Master
TC1250	29 pieces set	6	48

Type of packaging: Blister

Contents		
Tip	Size	
Pozi-driv	#1, #2, #3	
Flat	6-8, 8-10, 10-12	
Square	S1, S2, S3	
Phillips	#1, #2(2), #3	
Hexagonal	3/32", 1/8", 5/32", 3/16", 1/4", 5/16", 11/32", 3/8"	
Box	T-15, T20, T-25	
Torx	T-30	
1 magnetic adapter +3 plastic organizers		

1" BIT SET, 33 PIECES

- Made of S2 steel
- To be used with electric drill or screwdriver
- Drive: 1/4"
- Plastic organizer included



Contents		
Tip	Size	
Pozi-driv	#0, #1, #2, #3	
Flat	5-6, 6-8, 8-10, 10-12	
Square	S1, S2, S3	
Phillips	#0(2), #1 (3), #2 (3), #3	
Hexagonal	3/32", 1/8", 5/32", 3/16", 7/32", 1/4"	
Torx	T-10, T15, T-20, T-25, T-30, T-40	
1 magnetic adapter +3 plastic organizers		

Code	Characteristics	Inner	Master
TC1251	33 pieces set	6	48

Type of packaging: Blister

2" BIT SET, 9 PIECES

- Made of S2 steel
- To be used with electric drill or screwdriver
- Drive: 1/4"
- Plastic organizer included



Code	Characteristics	Inner	Master
TC1249	9 pieces set	6	48

Type of packaging: Blister

Contents		
Tip	Size	
Pozi-driv	#2	
Flat	3/16", 1/4"	
Square	S1, S2	
Phillips	#1, #2, #3	

2" TORX BIT SET, 7 PIECES

- Made of S2 steel
- To be used with electric drill or screwdriver
- Drive: 1/4"
- Plastic organizer included



Contents	
T-10	
T-15	
T-20	
T-25	
T-27	
T-30	
T-40	

Code	Characteristics	Inner	Master
TC1253	7 pieces set	12	72

Type of packaging: Blister

1" TORX BIT SET, 7 PIECES

- Made of S2 steel
- To be used with electric drill or screwdriver
- Drive: 1/4"
- Plastic organizer included



Contents	
T-10	
T-15	
T-20	
T-25	
T-27	
T-30	
T-40	

Code	Characteristics	Inner	Master
TC1252	7 pieces set	12	72

Type of packaging: Blister

2" SCREWDRIVER TIP SET, 5 PIECES

- Made of S2 steel
- To be used with electric drill or screwdriver
- Drive: 1/4"



Code	Capacity	Tip type	Inner	Master
TC1243	#0	Phillips	12	72
TC1244	#1	Phillips	12	72
TC1245	#2	Phillips	12	72
TC1246	3/16"	Flat	12	72
TC1247	1/4"	Flat	12	72

Type of packaging: Blister

2" SCREWDRIVER TIP SET, 5 PIECES

- Made of S2 steel
- To be used with electric drill or screwdriver
- Drive: 1/4"



*Price per blister

Code	Size	Inner	Master
TC1248	3 pieces Phillips (#0, #1, #2)	12	72
	1 pieces flat tip		
	4.8 mm (3/16")		
	6.4 mm (1/4")		

Type of packaging: Blister

1" SCREWDRIVER TIP SET, 5 PIECES

- Made of S2 steel
- To be used with electric drill or screwdriver
- Drive: 1/4"



*Price per blister

Code	Capacity	Tip type	Inner	Master
TC1237	#0	Phillips	12	72
TC1238	#1	Phillips	12	72
TC1239	#2	Phillips	12	72
TC1240	3/16"	Flat	12	72
TC1241	1/4"	Flat	12	72

Type of packaging: Blister

1" SCREWDRIVER TIP SET, 5 PIECES

- Made of S2 steel
- To be used with electric drill or screwdriver
- Drive: 1/4"



*Price per blister

Code	Size	Inner	Master
TC1242	3 pieces Phillips (#0, #1, #2)	12	72
	2 pieces flat tip		
	4.8 mm (3/16")		
	6.4 mm (1/4")		

Type of packaging: Blister

DISCS

SEGMENTED RIM ASPHALT DIAMOND BLADE

- Asphalt and concrete cutting
- 1" arbor



Abrasive section

Code	Thickness	Height
TC4498	3.2 mm	10 mm

⚠ For your safety never surpass the number of rpm set

Code	Diameter	Maximum RPM	Inner	Master
TC4498	For asphalt 14"	4,400	1	10

Type of packaging: Blister

TURBO RIM DIAMOND BLADE

- General cutting
- 5/8" adapter
- For cutting concrete, brick, marble, tile and construction materials.
- 7/8" arbor



Abrasive section

Code	Thickness	Height
TC4492	2.0 mm	7.5 mm
TC4493	2.2 mm	7.5 mm
TC4494	2.4 mm	7.5 mm
TC4495	2.6 mm	7.5 mm

⚠ For your safety never surpass the number of rpm set

Code	Diameter	Maximum RPM	Inner	Master
TC4492	4"	13,300	5	100
TC4493	4 1/2"	8,500	5	100
TC4494	7"	6,500	5	50
TC4495	9"	4,400	2	30

Type of packaging: Blister

SEGMENTED RIM DIAMOND BLADE

- Fast cutting
- 5/8" adapter
- Cuts: concrete, brick, stone, and construction materials
- For deep cutting
- 7/8" arbor



Abrasive section

Code	Thickness	Height
TC4491	1.8 mm	7.5 mm
TC2434	2.0 mm	7.5 mm
TC2435	2.2 mm	7.5 mm
TC2436	2.4 mm	7.5 mm

⚠ For your safety never surpass the number of rpm set

Code	Diameter	Maximum RPM	Inner	Master
TC4491	4"	13,300	5	100
TC2434	4 1/2"	13,300	5	100
TC2435	7"	8,500	5	50
TC2436	9"	6,500	2	30

Type of packaging: Blister

CONTINUOUS RIM DIAMOND BLADE

- Fine cutting
- 7/8" arbor
- 5/8" adapter
- Cuts: concrete, tile and marble
- Professional finish



Abrasive section

Code	Thickness	Height
TC4496	1.8 mm	5.5 mm
TC2432	2.0 mm	5.5 mm
TC2433	2.2 mm	5.5 mm
TC4497	2.4 mm	5.5 mm

⚠ For your safety never surpass the number of rpm set

Code	Diameter	Maximum RPM	Inner	Master
TC4496	4"	14,500	5	100
TC2432	4 1/2"	13,300	5	100
TC2433	7"	8,500	5	50
TC4497	9"	6,500	2	30

Type of packaging: Blister

CONTINUOUS RIM DIAMOND BLADE

- Fine cutting
- 7/8" arbor
- 5/8" adapter
- Cuts: concrete, tile, and marble
- Professional finish



Abrasive section

Code	Thickness	Height
WF0591	2.0 mm	5.5 mm
WF0592	2.2 mm	5.5 mm

⚠ For your safety never surpass the number of rpm set

Code	Diameter	Maximum RPM	Inner	Master
*WF0591	4 1/2"	13,300	10	100
WF0592	7"	8,500	4	50

Type of packaging: Blister

SEGMENTED RIM DIAMOND BLADE

- Fast cutting
- 7/8" arbor
- 5/8" adapter
- Cuts: concrete, brick, stone, and construction materials
- For deep cutting



Abrasive section

Code	Thickness	Height
WF0593	2.0 mm	7.5 mm
WF0594	2.2 mm	7.5 mm

⚠ For your safety never surpass the number of rpm set

Code	Diameter	Maximum RPM	Inner	Master
WF0593	4 1/2"	13,300	10	100
*WF0594	7"	8,500	4	50

Type of packaging: Blister

ABRASIVE FLAP DISC FOR GRINDING AND POLISHING TYPE 29

- Made of zirconia sandpaper
- For working in wood, fiberglass and metal
- 7/8" arbor



⚠ For your safety never surpass the number of rpm set

Code	Diameter	Thickness	Maximum RPM	Inner	Master
TC5191	7"	40	8,500	5	100
TC5192	7"	60	8,500	5	100
TC5193	7"	80	8,500	5	100
TC5194	7"	120	8,500	5	100

Type of packaging: Blister

ABRASIVE FLAP DISC FOR ROUGHING AND POLISHING TYPE 29

- Made of zirconia sandpaper
- To use in wood, fiberglass and metal
- 7/8" arbor



⚠ For your safety never surpass the number of rpm set

Code	Diameter	Thickness	Maximum RPM	Inner	Master
TC3465	4 1/2"	40	13,300	10	200
TC3466	4 1/2"	60	13,300	10	200
TC5190	4 1/2"	80	13,300	10	200
TC3467	4 1/2"	120	13,300	10	200

Type of packaging: Blister

ABRASIVE FLAP DISC FOR GRINDING AND POLISHING TYPE 29

- Made of zirconia sandpaper
- For working in wood, fiberglass and metal
- 7/8" arbor



⚠ For your safety never surpass the number of rpm set

Code	Diameter	Thickness	Maximum RPM	Inner	Master
WF0639	7"	40	8,500	5	100
WF0640	7"	60	8,500	5	100
WF0641	7"	80	8,500	5	100
WF0642	7"	120	8,500	5	100

Type of packaging: Blister

METAL CUTTING DISC TYPE 1

- Made of aluminum oxide with double fiberglass mesh
- For general cuts
- 1" arbor



⚠ For your safety never surpass the number of rpm set

Code	Diameter	Thickness	Maximum RPM	Inner	Master
TC1907	14"	3.2 mm	3,900	5	20

Type of packaging: Bulk

METAL AND STAINLESS STEEL EXTRA-FINE CUTTING DISC TYPE 1

- Made of aluminum oxide with fiberglass mesh
- 7/8" arbor



⚠ For your safety never surpass the number of rpm set

Code	Diameter	Thickness	Maximum RPM	Inner	Master
TC3456	4 1/2"	1 mm	13,300	10	60
TC3457	4 1/2"	1.2 mm	13,300	10	60
TC3458	7"	1.5 mm	8,500	10	50
TC3459	9"	2 mm	6,650	10	40

Type of packaging: Bulk

METAL FINE CUTTING DISC TYPE 1

- Made of aluminum oxide with fiberglass mesh
- 7/8" arbor



⚠ For your safety never surpass the number of rpm set

Code	Diameter	Thickness	Maximum RPM	Inner	Master
*TC1903	4 1/2"	1.6 mm	13,300	5	25
TC	7"	2 mm	8,500	5	25

Type of packaging: Bulk

METAL CUTTING DISC (TYPE 27)

- Made of aluminum oxide with fiberglass mesh
- 7/8" arbor



⚠ For your safety never surpass the number of rpm set

Code	Diameter	Thickness	Maximum RPM	Inner	Master
TC1905	4 1/2"	3.2 mm	13,300	25	200
TC1906	7"	3.2 mm	8,500	12	100
TC1914	9"	3.2 mm	6,650	5	25

Type of packaging: Bulk

METAL GRINDING DISC (TYPE 27)

- Made of aluminum oxide with fiberglass mesh
- 7/8" arbor



⚠ For your safety never surpass the number of rpm set

Code	Diameter	Thickness	Maximum RPM	Inner	Master
TC1908	4 1/2"	6.4 mm	13,300	10	20
TC1909	7"	6.4 mm	8,500	10	20
TC1915	9"	6.4 mm	6,650	5	25

Type of packaging: Bulk

CONCRETE GRINDING DISC (TYPE 27)

- Made of silicon carbide with fiberglass mesh
- 7/8" arbor



⚠ For your safety never surpass the number of rpm set

Code	Diameter	Thickness	Maximum RPM	Inner	Master
TC1912	4 1/2"	6.4 mm	13,300	10	100
TC1913	7"	6.4 mm	8,500	10	50

Type of packaging: Bulk

CONCRETE CUTTING DISC TYPE 27

- Made of aluminum oxide with fiberglass mesh
- 7/8" arbor



⚠ For your safety never surpass the number of rpm set

Code	Diameter	Thickness	Maximum RPM	Inner	Master
TC1910	4 1/2"	3.2 mm	13,300	25	200
TC1911	7"	3.2 mm	8,500	12	100
TC1916	9"	3.2 mm	6,650	5	50

Type of packaging: Bulk

METAL EXTRA-FINE CUTTING DISC TYPE 1

- Made of aluminum oxide
- For cutting metal and stainless steel
- Axis: 7/8"



⚠ For your safety never surpass the number of rpm set

Code	Diameter	Thickness	Maximum RPM	Inner	Master
*WF0698	4 1/2"	1 mm	13,200	25	400
WF0699	4 1/2"	1.2 mm	13,200	25	400
WF0701	7"	1.5 mm	8,600	20	200
WF0703	9"	2 mm	6,700	20	100

Type of packaging: Bulk

METAL FINE CUTTING DISC TYPE 1

- Made of aluminum oxide
- For cutting metal
- Axis: 7/8"



⚠ For your safety never surpass the number of rpm set

Code	Diameter	Thickness	Maximum RPM	Inner	Master
WF0700	4 1/2"	1.6 mm	13,200	25	400
WF0702	7"	1.8 mm	8,600	20	200

Type of packaging: Bulk

ABRASIVE FLAP DISC FOR GRINDING AND POLISHING TYPE 29

- Made of zirconia sandpaper
- For working in wood, fiberglass and metal
- 7/8" arbor



⚠ For your safety never surpass the number of rpm set

Code	Diameter	Thickness	Maximum RPM	Inner	Master
WF0635	4 1/2"	40	13,300	10	200
WF0636	4 1/2"	60	13,300	10	200
WF0637	4 1/2"	80	13,300	10	200
WF0638	4 1/2"	120	13,300	10	200

Type of packaging: Blister

METAL CUTTING DISC TYPE 1

- Made of aluminum oxide
- For cutting metal
- Axis: 1"



⚠ For your safety never surpass the number of rpm set

Code	Diameter	Thickness	Maximum RPM	Inner	Master
WF0704	14"	2.8 mm	4,400	5	25

Type of packaging: Bulk

PIPE BENDER

- Made of steel
- Foot lever for better support
- Bending angle of 10° or 90°



Code	Diameter	Inner	Master
TC5401	1/2"	1	20
TC5402	3/4"	1	20
TC5403	1"	1	10

Type of packaging: Box

LADDERS

FIBERGLASS EXTENSION LADDER TYPE II

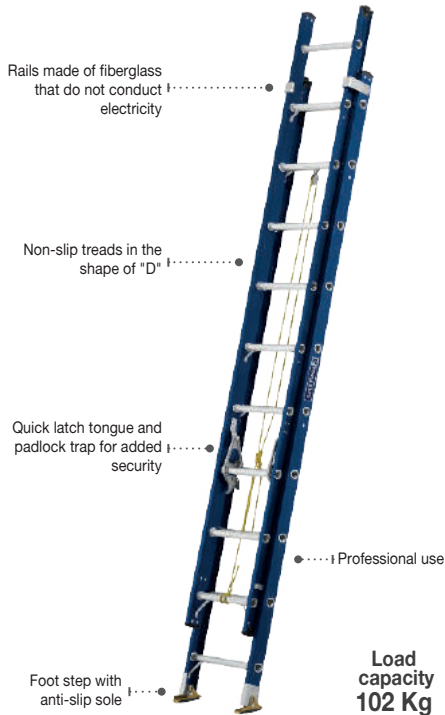

Load capacity 102 Kg

Code	Steps	Weight	Extended height	Not extended height	Inner	Master
TC5302	20	15.7 kg	5.23 m	3.07 m	1	1
TC5303	24	21.3 kg	6.40 m	3.68 m	1	1

Type of packaging: Bulk

ALUMINUM EXTENSION LADDER TYPE III

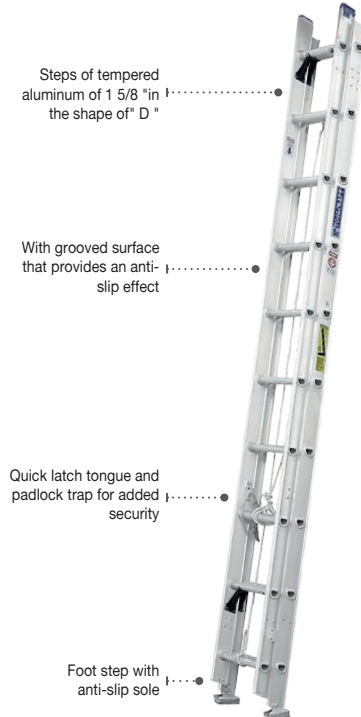

Load capacity 90 Kg

Code	Steps	Weight	Extended height	Not extended height	Inner	Master
TC3510	16	8.2 kg	3.96 m	2.46	1	1
TC3511	20	11.4 kg	5.23 m	3.07	1	1
TC3512	24	14 kg	6.40 m	3.68	1	1
TC3513	28	17.7 kg	7.62 m	4.29	1	1

Type of packaging: Bulk

MULTI-POSITION LADDER TYPE I 12 STEPS

- Mechanism of articulation with lock
- Nonslip plastic foot steps
- Stabilizer bar at both ends
- Includes 2 trays for use as scaffolding
- Foldable for easy storage and transportation



Load capacity 150 Kg

Max range (extended)	4.7 m
Max range (step ladder)	3 m
Max range (scaffolding)	2.5 m

Code	Steps	Weight	Inner	Master
TC5412	12	12.3 kg	1	1

Type of packaging: Bulk

ALUMINUM CONVERTIBLE STEP LADDER TYPE II

- Can be used as stepladder, extension and / or slope
- Oval steps
- Anti-pinch braces
- Anti-slip food pads for safety
- Hook design for support of mobile section integrated to the step
- Front section of straight construction and wider for good stability
- Professional use



Load capacity 102 Kg

	Stepladder	Extension
Total height	1.83m	3.22m
Maximum height to stand	1.14m	2.30m
Maximum scope of work	3.14m	4.30m

Code	Steps	Weight	Inner	Master
TC5305	13	8.6 kg	1	1

Type of packaging: Bulk

FIBERGLASS STEP LADDER TYPE II PLASTIC TOP



Load capacity 102 Kg

Code	Steps	Weight	Total Height	Inner	Master
TC5246	4	5.5 kg	5' (1.52m)	1	1
TC5247	5	6.12 kg	6' (1.83m)	1	1

Type of packaging: Bulk

ALUMINUM SMALL STEP LADDER TYPE III PLASTIC TOP CAP

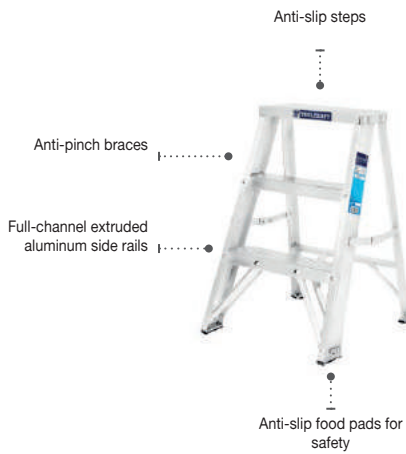

Load capacity
90 Kg

Code	Steps	Weight	Height	Inner	Master
TC5304	2	2 kg	0.58 m	1	1

Type of packaging: Bulk

ALUMINUM STEP LADDER TYPE III PLASTIC TOP CAP

- Load capacity of 90 kg
- Steps with non-slip surface
- Anti-pinch braces
- Full channel extruded aluminum side rails
- Anti-slip food pads for safety
- Bucket tray holder
- Aluminum top cap



Load capacity
90 Kg

Code	Steps	Weight	Total height	Inner	Master
TC4518	4	4.5 kg	5' (1.52 m)	1	1
TC4519	5	5.2 kg	6' (1.83 m)	1	1
TC4520	6	5.8 kg	7' (2.13 m)	1	1

Type of packaging: Bulk

ALUMINUM STEP LADDER TYPE III PLASTIC TOP

- 90 kg load capacity
- Anti-slip grooved surface
- Anti-pinch braces
- Pail shelf
- Slotted lid for easy tool placement
- Full channel extruded aluminum side rails
- Anti-slip food pads for safety
- Household use
- Pail shelf non included on TC3205 model



Load capacity
90 Kg

Code	Steps	Weight	Total height	Inner	Master
TC3205	2	3.6 kg	3' (0.91 m)	1	1
TC3206	3	4 kg	4' (1.22 m)	1	1
TC3207	4	5 kg	5' (1.52 m)	1	1
*TC3208	5	5.5 kg	6' (1.83 m)	1	1
*TC3209	6	6.4 kg	7' (2.13 mm)	1	1

Type of packaging: Bulk

ALUMINUM STEP LADDER TYPE III, PLASTIC TOP CAP

Wolfox

- Steps with non-slip surface
- Anti-pinch braces
- Black top cap with slots for easy tool handling
- Anti-slip foot pads
- Household use
- Pail shelf not included with this model



Load capacity
90 Kg

Code	Steps	Weight	Height	Inner	Master
WF9541	3	3.5 kg	4' (1.22 m)	1	1
WF9542	4	4 kg	5' (1.52 m)	1	1
WF9543	5	4.5 kg	6' (1.83 m)	1	1
WF9813	6	4.9 kg	7' (2.13 m)	1	1

Type of packaging: Bulk

STEP STOOL LADDER

Wolfox

**NEW
PRODUCT**

- Steps with anti-slip surface
- Anti-slip foot pads
- Foldable
- Step size: 38 cm x 26 cm
- Household use



Load capacity
90 Kg

Code	Steps	Weight	Height (2nd step)	Inner	Master
WF9732	2	4.8 kg	0.49 m	1	4
WF0786	3	6.5 kg	0.73 m	1	4

Type of packaging: Bulk

2-STEP STOOL

Wolfox

- Made of 1 piece polypropylene
- Anti-slip steps
- Household use
- Folding design for optimal packing and storage



Load capacity
130 Kg

Code	Steps	Weight	Height	Inner	Master
WF0597	2	1.25 kg	0.34 m	3	12

Type of packaging: Bulk

STAPLERS | SQUARES

2-IN-1 STAPLE GUN HEAVY DUTY

- Heavy duty steel body
- Vinyl-lined handle
- Compatible with Toolcraft staples 6 mm - 14 mm (1/4" - 9/16") TC0652, TC0653, TC0654, TC0655 and TC0656
- For nail with head of 12 mm - 15 mm
- Compatible with the nail Toolcraft TC0657

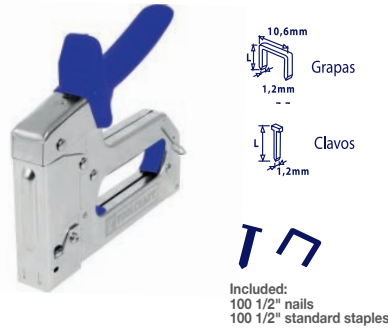

Code	Model	Characteristics	Inner	Master
TC5308	T-50	2 in 1 heavy duty	2	12

Type of packaging: Blister

3-IN-1 STAPLE GUN

- Heavy duty steel body
- Pressure adjustment handle
- Compatible with Toolcraft staples 4 mm - 14 mm (5/32" - 9/16") TC0652, TC0653, TC0654, TC0656
- Cable staples 8 mm - 14 mm (5/16" - 9/16")
- Head nail 8 mm - 12 mm (5/16" - 5/32")
- Trigger lock



Code	Model	Characteristics	Inner	Master
TC0589	T-50	3 in 1 professional	2	24

Type of packaging: Blister

STAPLE GUN

- Steel body
- For staples of 4 mm - 8 mm (5/32" - 5/16")
- Compatible with Toolcraft staples TC0658 y TC0659
- Trigger lock

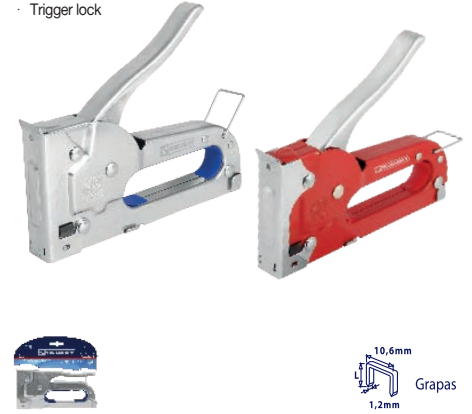

Code	Model	Color	Inner	Master
TC0587	T-21	Chromed	3	24
TC0588	T-21	Red	3	24

Type of packaging: Blister

NAILS FOR STAPLE GUN

- Standard staples for carpentry, electrical and tapestry works
- Box with 1,000 staples

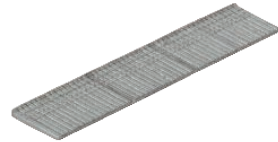

Box
1000 nails
*Price per box

Code	Size	Inner	Master
TC0657	1/2"	5	200

Type of packaging: Box

STAPLE

- Standard nails for carpentry, electrical and tapestry works.
- Box with 1,000 nails

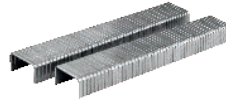

Box
1000 staples
*Price per box

Code	Size	For model	Inner	Master
TC0652	1/4"	T-50	10	200
TC0653	5/16"	T-50	10	200
TC0654	3/8"	T-50	10	200
TC0655	1/2"	T-50	10	200
TC0656	9/16"	T-50	10	200
TC0658	1/4"	T-21	10	300
TC0659	5/16"	T-21	10	300

Type of packaging: Box

COMBINATION SQUARE

- Stamped marking, in inches and centimeters
- Stainless steel ruler



Code	Size	Inner	Master
TC0842	12"	6	36

Type of packaging: Cover

CARPENTER'S FRAMING SQUARE

- Steel body
- Stamped marking, in inches and centimeters



Code	Size	Inner	Master
TC0839	8" x 12"	6	36
TC0840	16" x 24"	6	36

Type of packaging: Bulk

ALUMINUM HANDLE CARPENTER'S SQUARE

- Stainless steel ruler
- Stamped marking in inches



Code	Size	Inner	Master
TC0831	6"	6	36
TC0832	8"	6	36
TC0833	10"	6	36
TC0834	12"	6	36

Type of packaging: Bulk

SLIDING T BEVEL SQUARE

- Stainless steel blade
- High impact plastic handle



Code	Size	Inner	Master
TC0843	8"	6	36

Type of packaging: Blister

RIGID SCRAPER, DUAL-MATERIAL HANDLE

- Polished steel body specially treated to prevent corrosion
- Dual-material handle
- Metal end cap



Code	Size	Inner	Master
TC1780	1"	12	72
TC1781	2"	12	72
TC1782	3"	12	72

Type of packaging: Bulk

FLEXIBLE SCRAPER, DUAL-MATERIAL HANDLE

- Polished steel body specially treated to prevent corrosion
- Dual-material handle
- Metal end cap



Code	Size	Inner	Master
TC1783	1"	6	72
TC1784	2"	6	72
TC1785	3"	6	72
TC1786	4"	6	72
TC1787	5"	6	72

Type of packaging: Bulk

RIGID SCRAPER, DUAL-MATERIAL HANDLE **Wolfox**

- Steel body carbon steel



Code	Size	Inner	Master
WF3107	2"	12	60
WF3108	3"	12	60

Type of packaging: Bulk

FLEXIBLE SCRAPER, PLASTIC HANDLE

Wolfox

- Steel body carbon steel



Code	Size	Inner	Master
WF3101	1"	12	60
WF3102	2"	12	60
WF3103	3"	12	60
WF3104	4"	12	60
WF3105	5"	12	60

Type of packaging: Bulk

STEEL WEDGE

Wolfox

- Flexible blade
- Thick: 0.3 mm



WF9724

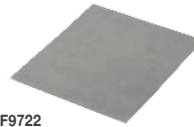

WF9722

Code	Size	Characteristics	Inner	Master
WF9721	8 x 10 cm	Sin mango	50	600
WF9722	10 x 13.5 cm	No handle	50	600
WF9723	8 x 10 cm	With handle	50	800
WF9724	10 x 13.5 cm	With handle	50	800

Type of packaging: Bulk

WOOD CHISEL, DUAL MATERIAL HANDLE

- 25° cutting angle
- Bar length: 5 1/2"
- Polished and beveled bar, forged on heat treated alloy steel with 62 RC hardness.



Code	Size	Inner	Master
TC1771	1/4"	6	18
TC1772	3/8"	6	18
TC1773	1/2"	6	18
TC1774	5/8"	6	18
TC1775	3/4"	6	18
TC1776	7/8"	6	18
TC1777	1"	6	18
TC1778	1 1/4"	6	18
TC1779	1 1/2"	6	18

Type of packaging: Bulk

3-PIECE, WOOD CHISEL SET

- Made of carbon steel
- PVC Handle
- 25° cutting angle



Wolfox

Code	Measures	Inner	Master
WF0084	1/2", 3/4", y 1"	6	24

Type of packaging: Blister

WIDE MEASURING TAPE

- Made of ABS resin with PTR protection
- White one-sided printed tape
- Three measuring scales: centimeters, inches and feet
- 1 thumb power lock
- Stainless steel single hook
- Wide tape for a better extension and easy reading

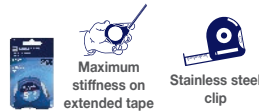

Maximum stiffness on extended tape

Stainless steel clip



Code	Length	Width	Inner	Master
TC0236	3 m	19 mm (3/4")	6	48
TC0237	5 m	25 mm (1")	6	36
TC1640	8 m	30 mm (1 3/16")	4	24

Type of packaging: Blister

MAGNETIC MEASURING TAPE

- Made of ABS resin with rubber protection
- Yellow two-sided printed tape
- Three measuring scales: centimeters, inches and feet
- 1 thumb power lock
- Stainless steel double hook
- Magnetized end



Stainless steel clip



Hook with three rivets for better fastening



Code	Length	Width	Inner	Master
TC1417	3 m	16 mm (5/8")	8	72
TC1418	5 m	19 mm (3/4")	8	72
TC1419	8 m	25 mm (1")	6	24

Type of packaging: Blister

STANDARD MEASURING TAPE

- Made of ABS resin with rubber protection
- Yellow one-sided printed tape
- Three measuring scales: centimeters, inches and feet
- 1 thumb power lock and 1 button brake
- Stainless steel single hook



Stainless steel clip



Hook with three rivets for better fastening



Code	Length	Width	Inner	Master
TC0234	3 m	16 mm (5/8")	6	144
TC0235	5 m	19 mm (3/4")	6	72
TC0353	8 m	25 mm (1")	6	48

Type of packaging: Blister

MEASURING TAPES

DUAL-MATERIAL MEASURING TAPE

- Made of ABS with rubber cover
- White ribbon printed on both sides
- Three measuring scales: centimeters, inches and feet
- 1 thumb power lock and 2 button brakes
- Stainless steel hook with magnetized ends

Wolfox



NOM i1 onnce

Code	Color	Length	Width	Inner	Master
WF9491	Green	3m	16 mm (5/8")	12	72
*WF9492	Green	5m	19 mm (3/4")	12	72
WF9666	Green	7.5m	25 mm (1")	6	72
WF9663	Yellow	3m	16 mm (5/8")	12	72
WF9664	Yellow	5m	19 mm (3/4")	12	72
WF9665	Yellow	7.5m	25 mm (1")	6	72

Type of packaging: Blister

WIDE MEASURING TAPE

- Made of ABS
- White one-sided printed tape
- Three measuring scales: centimeters, inches and feet
- 1 thumb power lock
- Stainless steel single hook

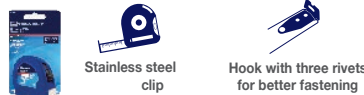

NOM i1 onnce

Code	Length	Width	Inner	Master
TC1488	3m	12.7 mm (1/2")	6	144
TC1490	5m	19 mm (3/4")	6	72
TC1492	8m	25 mm (1")	6	48

Type of packaging: Blister

WIDE MEASURING TAPE

- Plastic strap
- White one-sided printed tape
- Material: high resistance ABS plastic

Wolfox



NOM i1 onnce

Code	Length	Width	Inner	Master
WF3503	3 m	12.7 mm (1/2")	12	144
WF3505	5 m	19 mm (3/4")	12	72
WF3506	7.5 m	25 mm (1")	12	48

Type of packaging: Blister

SOLID MEASURING TAPE SET

- Plastic belt
- Stainless steel clip
- White one-sided printed tape
- Material: high resistance ABS plastic
- Includes clip
- Assorted colors,
- Included:
- green, orange and yellow

Wolfox



NOM i1 onnce

Price per measuring tape

Code	Color	Length	Width	Inner	Master
WF3513	Orange / 12 pcs	3 m	12.7 mm (1/2")	36	72
WF3515	Orange / 9 pcs	5 m	19 mm (3/4")	27	54
WF3523	Colors / 12 pcs	3 m	12.7 mm (1/2")	36	72
WF3525	Colors / 9 pcs	5 m	19 mm (3/4")	27	54

Type of packaging: Blister

LONG FIBERGLASS TAPE 1/2" CROSS TYPE

- ABS box with metal center
- TPR handle
- Fast rewind system
- Two sided printing
- Two scales: Metric and English



Code	Length	Inner	Master
TC0289	30 m	1	20
TC0290	50 m	1	10
TC0291	100 m	1	10

Type of packaging: Box

1/2" WIND DRUM FIBERGLASS LONG MEASURING TAPE

- ABS box with metal center
- Two sided printing
- Two scales: Metric and English



Code	Length	Inner	Master
TC0292	10 m	3	40
TC0293	15 m	3	40
TC0294	30 m	1	40
TC0295	50 m	1	20

Type of packaging: Blister

1/2" WIND DRUM FIBERGLASS LONG MEASURING TAPE

Wolfox

- Resistant ABS plastic box
- Two sided printing
- Two scales: Metric and English



Code	Length	Inner	Master
WF9379	20 m	3	24
WF9380	30 m	3	24

Type of packaging: Blister

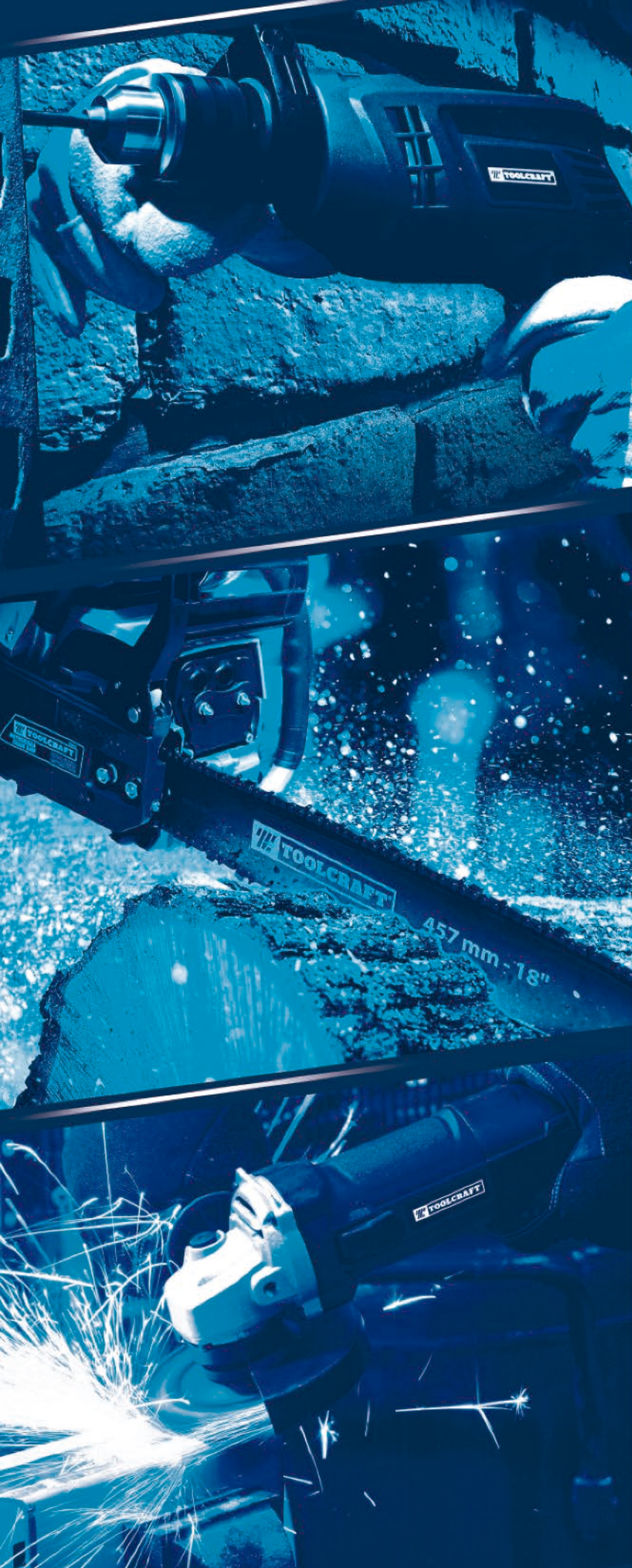

POWER TOOLS

| VACUUM CLEANERS

| PUMPS

| COMPRESSORS

| BRUSH CUTTERS

| GRINDERS

| FUMIGATORS

| GENERATORS

| PRESSURE WASHERS

| STATIONARY MACHINES

| CHAINSAWS

| MULTITool

| ROUTERS

| HAMMER DRILLS

| SAWS

| JIG SAWS

| WELDER

VACUUM CLEANERS

12-GALLON, 5.5HP VACUUM CLEANER

- Wet and dry vacuum cleaner
- 120 V~ 60 Hz
- 2 functions: vacuum cleaner/blower
- 3 m power cable

- Includes
- 2 extensions
 - Corner nozzle
 - Floor brush
 - 1 dust filter
 - 1 liquid filter
 - 1 vacuum cleaner bag with fastening ring
 - 1 1 7/8" x 1.80 m hose
 - 4 casters

Workload:
45 min of work x
20 min of rest
Maximum daily: 6 hrs



WARRANTY
2 YEARS

NOM

Code	Power	Gallons	Rated electrical power	Inner	Master
TC4185	5.5 HP	12	1,300 W	1	1
Spare parts				Inner	Master
TC4185FP		Vacuum Paper Filter		1	25
TC4184FT		Vacuum Fabric Filter		1	100

Packaging: Box/ Spare parts: Bag

6-GALLON, 4 HP VACUUM CLEANER

- Wet and dry vacuum cleaner
- 120 V~ 60 Hz
- 2 functions: vacuum cleaner/blower
- 3 m power cable

- Includes:
- 2 extensions
 - 2 noozles (flat and corner)
 - 1 dust filter
 - 1 liquid filter
 - 1 vacuum cleaner bag with fastening ring
 - 1 1 1/4" x 1.80 m hose
 - 4 casters

Workload:
25 min of work x
15 min of rest
Maximum daily: 3 hrs



WARRANTY
2 YEARS

NOM

Code	Power	Gallons	Rated electrical power	Inner	Master
TC4184	4 HP	6	900 W	1	1
Spare parts				Inner	Master
TC4184FP		Vacuum Paper Filter		1	25
TC4184FT		Vacuum Fabric Filter		1	100

Packaging: Box / Spare parts: Bag

3-GALLON, VACUUM CLEANER

- Wet and dry vacuum cleaner
- 120 V~ 60 Hz
- 1.8 m power cable

- Includes:
- 1 1/4" x 1.2 m hose
 - Vacuum cleaner bag with fastening ring
 - 2 noozles (flat and corner)
 - Foam filter



WARRANTY
2 YEARS

NOM

Code	Power	Rated power	Gallons	Inner	Master
TC5442	3 HP	900 W	3	1	1
Spare parts				Inner	Master
TC5442FT		Vacuum Fabric Filter		1	100
TC5442FE		Vacuum Foam Filter		1	100

Packaging: Box/ Spare parts: Bag

BULLET SUBMERSIBLE WELL PUMP TYPE FOR CLEAN WATER

- 120 V ~ 60 Hz
- Stainless steel body
- Control box included
- Bronze outlet nozzle
- 1 1/2" output diameter
- Maximum depth: 40 m
- For pumping clean water on wells and natural springs with a 4" diameter
- Bronze outlet nozzle

Workload:
3 min of work x
15 min of rest
Maximum daily: 18 hrs



· Power cable: 3 m



WARRANTY
2 YEARS

NOM

Code	Power	Maximum height	Maximum flow	Inner	Master
TC4576	1 HP	55 m	6,600 l/hr	1	1
TC4577	2 HP	100 m	6,900 l/hr	1	1

Packaging: Box

SUBMERSIBLE CLEAN WATER PUMP

- 120 V ~ 60 Hz
- Aluminum body
- Floater included
- 1" output diameter
- Speed: 3,450 rpm
- Maximum depth: 8 m
- For draining and/or emptying water from wells, waterwheels, cisterns.
- Bronze outlet nozzle

· HEAVY DUTY

Workload:
3 min of work x
15 min of rest
Maximum daily: 18 hrs



· Power cable: 10 m



WARRANTY
2 YEARS

NOM

Code	Power	Maximum height	Maximum flow	Maximum depth	Inner	Master
TC4574	1 HP	33 m	7,600 l/hr	8 m	1	2
TC4461	1/2 HP	12 m	5,820 l/hr	9 m	1	4

Packaging: Box

HYDROPNEUMATIC PUMPS | WITH PRESSURIZER | MOTOR PUMPS

STAINLESS STEEL SUBMERSIBLE DIRTY WATER PUMP

- 120 V - 60 Hz
- Float included
- Outlet plastic connector in two sizes 1" and 1 1/2"
- 46.3 mm, 35.1 mm
- 31.4 mm, 24.8 mm
- Passes particles measuring up to 35mm
- Speed: 3,450 rpm
- Maximum depth: 8 m
- For draining and/or emptying water from wells, waterwheels and cisterns.

HEAVY DUTY

Workload:
3 hr of work x
15 min of rest
Maximum daily: 18 hr



Power cable: 10 m

WARRANTY
2 YEARS
WARRANTY
NOM

Code	Power	Maximum height	Maximum flow	Inner	Master
TC4462	1 HP	8 m	12,500 l/hr	1	4
TC4575	1 1/2 HP	9 m	15,000 l/hr	1	4

Packaging: Box

SUBMERSIBLE CLEAN WATER PUMP

- 120 V - 60 Hz
- Float switch
- Plastic connector with adapter for hose: 1", 1 1/4", 1 3/8" and 1 13/16"
- Speed: 2,800 rpm
- Maximum depth: 8 m
- For draining and/or emptying water from wells, waterwheels and cisterns.

Workload:
3 min of work x
15 min of rest
Maximum daily: 18 hrs



Power cable: 10 m

WARRANTY
2 YEARS
WARRANTY
NOM

Code	Power	Maximum height	Maximum flow	Inner	Master
TC3503	1/2 HP	9 m	9,000 l/hr	1	4
TC3504	1 HP	10 m	12,000 l/hr	1	4

Packaging: Box

SUBMERSIBLE DIRTY WATER PUMP

- 120 V - 60 Hz
- Float switch
- TC3505: output plastic connector with adapter for hose: 1", 1 1/4", 1 3/8" and 1 13/16"
- TC4460: output plastic connector with adapter for hose: 1" and 1 1/2"
- Passes particles measuring up to 35mm
- Speed:
- TC3505: 2,800 rpm
- TC4460: 3,500 rpm
- Maximum depth: 8 m
- For draining and/or emptying water from wells, waterwheels and cisterns

Workload:
3 min of work x
15 min of rest
Maximum daily: 18 hrs



Power cable: 10 m

WARRANTY
2 YEARS
WARRANTY
NOM

Code	Power	Maximum height	Maximum flow	Inner	Master
TC3505	1 HP	11 m	12,500 l/hr	1	4
TC4460	1 1/2 HP	11 m	14,000 l/hr	1	4

Packaging: Box

1 1/2 HP BOOSTER PUMP, 150 LITERS

- 120 V-60 Hz
- For 15 simultaneous water inlets
- 1" NPT inlet/outlet
- Speed: 3,450 rpm
- Maximum depth: 9 m
- Pressure: 20-40 PSI
- Constantly boosts pressure

Workload:
1 min of work x
15 min of rest
Maximum daily: 12 hrs



Power cable with plug: 1.5 m

WARRANTY
2 YEARS
WARRANTY

Code	Power	Maximum Height	Maximum Flow	Inner	Master
TC4459	1 1/2 HP	48 m	75 L/min	1	1

Packaging: Box

BOOSTER PUMP

- 127 V - 60 Hz
- 1" NPT inlet/outlet
- Speed: 3,450 rpm
- Maximum depth: 9 m
- Pressure: 20-40 PSI

Workload:
1 min of work x
15 min of rest
Maximum daily: 12 hrs



Power cable with plug: 1.4 m

WARRANTY
2 YEARS
WARRANTY

Code	Power	Maximum Height	Maximum Flow	Tank	Water Inlets	Inner	Master
TC4458	1/2 HP	35 m	60 L/min	50 L	6	1	1
TC3543	1/2 HP	38 m	50 L/min	24 L	4	1	1

Packaging: Box

1HP PRESSURE BOOSTER PUMP

- 127 V - 60 Hz
- 1HP pressurizer
- Jet engine and plastic impeller
- Ideal for 4 simultaneous water inlets
- 1" NPT inlet/outlet
- Factory calibrated pressure switch
- Speed: 3,450 rpm
- Maximum depth: 8 m
- System starts up when a water inlet is opened
- Constantly boosts water pressure

Workload:
1 min of work x
15 min of rest
Maximum daily: 12 hrs



Power cable with plug: 1.4 m

WARRANTY
2 YEARS
WARRANTY

Code	Power	Maximum Height	Maximum Flow	Inner	Master
TC4457	1 HP	38 m	53 L/min	1	1

Packaging: Box

MOTOR PUMPS

- 4-stroke gasoline engine
- Useful for effectively moving large quantities of water
- Manual ignition system (retractable rope)
- Maximum suction depth: 5m

Workload:
1 tank
20 min of rest



*Does not generate VAT
Agricultural Use



4-stroke engine: gasoline and oil are supplied in separate tanks

WARRANTY
1 YEAR
WARRANTY

Code	Input and output diameter	Maximum power	Maximum flow	Maximum pumping height	Inner	Master
TC5518	2"	7 Hp / 212 cc	500 L/min	30 m	1	1
TC5519	3"	7 Hp / 212 cc	900 L/min	30 m	1	1

Packaging: Box

FLAT HOSE FOR WATER PUMP

- Made of PVC
- For agricultural irrigations, construction or industrial projects
- Operating temperature: -5° C to 60° C
- Wall thickness: 1.2 mm



Code	Measure	Weight	Maximum pressure	Inner	Master
TC5295	2" x 50 m	0.22 kg/m	174 PSI	1	1
TC5296	2" x 100 m	0.22 kg/m	174 PSI	1	1
TC5297	3" x 50 m	0.40 kg/m	160 PSI	1	1
TC5298	4" x 50 m	0.53 kg/m	145 PSI	1	1

Packaging: Roll



PERIPHERAL PUMP

These are ideal for locations where high-water pressure is required, since they generate a greater thrust, although the water flow is lower.

1/2 HP

Input/Output: 1NPT
NOM



WARRANTY
2 YEARS



WARRANTY
1 YEAR



WARRANTY
1 YEAR

NEW PRODUCT *Rotter*



Code	TC2666	WF9710	RO0099
Maximum Height:	30 m	28 m	20 m
Maximum Flow:	40 L/m	35 L/m	28 L/m
Work Cycle:	1 hr. of work x 20 min of rest	1 hr. of work x 20 min of rest	20 min of work x 15 min of rest
Maximum Depth:	8 m	8 m	7 m
Speed:	3 450 rpm	3 450 rpm	3 450 rpm
Packaging:	Box 1 / Master 2	Box 1 / Master 4	Box 1 / Master 6



- For clean water.
- Brass impeller.
- Weather resistant.
- Low power consumption.
- Anti-lock System**
- Quiet operation.

* These products do not generate VAT. ** Exclusive for TC y WF pumps

3/4 HP

Input/Output: 1NPT
NOM

WARRANTY
2 YEARS



WARRANTY
1 YEAR

NEW PRODUCT *Wolfbox*



Code	TC2667	WF0846
Maximum Height:	55 m	45 m
Maximum Flow:	50 L/m	45 L/m
Work Cycle:	1 hr. of work x 20 min of rest	1 hr. of work x 20 min of rest
Maximum Depth:	8 m	8 m
Speed:	3 450 rpm	3 450 rpm
Packaging:	Box1 / Master 2	Box1 / Master 2

PERFORMANCE CURVE

Performance comparison between height and flow of each of our models

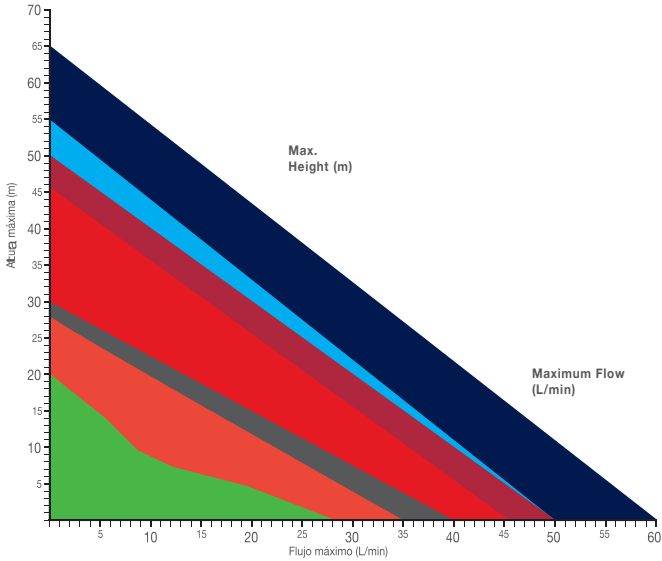

WARRANTY
2 YEARS



WARRANTY
1 YEAR

NEW PRODUCT *Wolfbox*



1 HP

Input/Output: 1NPT
NOM

Code	TC2665	WF0847
Maximum Height:	65 m	50 m
Maximum Flow:	60 L/m	50 L/m
Work Cycle:	1 hr. of work x 20 min of rest	1 hr. of work x 20 min of rest
Maximum Depth:	8 m	8 m
Speed:	3 450 rpm	3 450 rpm
Packaging:	Box 1 / Master 2	Box 1 / Master 2



COMPRESSORS

Vertical Air Compressor

· 120 V- single-phase



2 Air outputs with quick connection



High and Low Pressure Gauge



WARRANTY
2 YEARS



Air-output ball valve



All compressors have high and low pressure output. Large pressure gauge shows high pressure output and the small adjustable gauge pressure shows low-pressure output. Use oil SAE 40.

WARNING

This equipment MUST BE USED with a 115V to 125V Power Supply, using a DIFFERENT VOLTAGE WILL SEVERLY DAMAGE the product.



WARRANTY
2 YEARS



NOM



	200 L	50 L
Code	TC5430	TC5483
Tank:	51 gal	13 gal
Rated Power:	3 HP	2 HP
Maximum Power:	3.6 HP	2.5 HP
Motor:	Lubricated motor head with two pistons that allow filling tank faster	Lubricated motor with copper winding
Transmission:	Belt drive for heavy duty	No
Pressure Gauge:	Double	
Pressure Range:	80 / 115 PSI	87 / 115 PSI
Air Flow:	8.3 CFM @ 40 PSI / 5.4 CFM @ 90 PSI	4.8 CFM @ 40 PSI / 4.0 CFM @ 90 PSI
Continuous Flow:	236 L / min	136 L / min
Speed:	3 428 rpm	3 354 rpm
Work Cycle:	8 hrs max. per day / (DO NOT EXCEED 4 LOADS PER HOUR)	
Tires:	6" Hard Wheels	Hard Wheels
Drain Valve:		Yes
Air Outlets:	2 with quick connection and 1 Air-output ball valve	2 with quick connection
Air Filter:		Yes
Weight:	89.4 Kg	32.45 Kg
Inner:	1	
Master:	1	
Packaging:	Box	

POWER TOOLS | COMPRESSORS

AIR COMPRESSOR

- 120 V - single-phase
- Lubricated motor with copper winding
- Aluminum suction pipes
- 2 air outputs with quick connection
- Air filter included
- Drain valve
- 2 hard wheels



2 Air outputs with quick connection



Pressure gauge for high and low pressure



All compressors have high and low pressure output. Large pressure gauge shows high pressure output and the small adjustable gauge pressure shows low-pressure output. Use oil SAE 40.

WARNING

This equipment MUST BE USED with a 115V to 125V Power Supply, using a DIFFERENT VOLTAGE WILL SEVERELY DAMAGE the product.



WARRANTY
2 YEARS
WARRANTY



WARRANTY
2 YEARS
WARRANTY



WARRANTY
2 YEARS
WARRANTY



NOM

NOM

NOM

Code	100 L TC5431	50 L TC5432	24 L TC5433
Tank:	26 gal	13 gal	6.2 gal
Rated Power:	3 HP		2 HP
Maximum Power:	3.6 HP		2.5 HP
Motor:	Lubricated motor head with two pistons that allow filling tank faster		Lubricated motor with copper winding
Transmission:	Belt drive for heavy duty		No
Pressure Range:	80 / 115 PSI		87 / 115 PSI
Air Flow:	8.3 CFM @ 40 PSI / 5.4 CFM @ 90 PSI		4.8 CFM @ 40 PSI / 4.0 CFM @ 90 PSI
Continuous Flow:	236 L / min		136 L / min
Speed:	3 400 rpm	3 354 rpm	3 400 rpm
Work Cycle:	8 hours max per day. / (DO NOT EXCEED 4 LOADS PER HOUR)		
Weight:	90 Kg	29.45 Kg	24 Kg
Inner:		1	
Master:		1	
Packaging:	Box		

AIR COMPRESSOR KIT

- 120 V - single-phase
- Double pressure gauge
- 2 air outputs with quick connection
- Pressure range: 85/116 PSI
- Drain valve
- Speed: 3,400 rpm
- Weight: 20 kg
- Air Flow:
4.2 CFM @ 40 PSI
3.2 CFM @ 90 PSI

Work Cycle:
8 hrs max. per day /
(DO NOT EXCEED 4
LOADS PER HOUR)



WARRANTY
2 YEARS
WARRANTY

NEW
PRODUCT

INCLUDES

1 L low pressure spray gun and hose with connectors



PORTABLE AIR COMPRESSOR SELF-LUBRICATED

- 120 V - single-phase
- 2/oil-free motor
- Double pressure gauge
- 2 air outputs with quick connection
- Pressure range: 85/125 PSI
- Drain valve
- Speed: 3,400 rpm
- Weight: 22 kg
- Air Flow:
3.7 CFM @ 40 PSI
2.7 CFM @ 90 PSI

Work Cycle:
8 hrs max. per day /
(DO NOT EXCEED 4
LOADS PER HOUR)



All compressors have high and low pressure output. Large pressure gauge shows high pressure output and the small adjustable gauge pressure shows low-pressure output. Use oil SAE 40.



WARRANTY
2 YEARS
WARRANTY



2 Air outputs with quick connection



Pressure gauge for high and low pressure

WARNING

This equipment MUST BE USED with a 115V to 125V Power Supply, using a DIFFERENT VOLTAGE WILL SEVERELY DAMAGE the product.



21 L

Code	Tank	Rated Power	Maximum Power	Continuous Flow	Inner	Master
TC5590	6.2 gal	1.5 HP	2.4 HP	180 L / min	1	1

Packaging: Box/ All packed in a single Box

24 L

Code	Tank	Rated Power	Maximum Power	Continuous Flow	Inner	Master
TC5293	24 L / 6.2 gal	1.5 HP	2 HP	104 L / min	1	1

Packaging: Box

AIR COMPRESSOR

- 120 V~ single-phase
- Double Pressure Gauger
- 2 air outputs with quick connection
- Air filter included
- Drain valve
- 2 hard wheels and legs
- Speed: 3,400 rpm

Wolfox



2 Air outputs with quick connection



Pressure gauge for high and low pressure



NOM

40 L

WF0735

WARRANTY
1 YEAR
WARRANTY



Wolfox



All compressors have high and low pressure output. Large pressure gauge shows high pressure output and the small adjustable gauge pressure shows low-pressure output. Use oil SAE 40.

WARNING

This equipment MUST BE USED with a 115V to 125V Power Supply, using a DIFFERENT VOLTAGE WILL SEVERLY DAMAGE the product.



NOM

24 L

WF0736

WARRANTY
1 YEAR
WARRANTY



Code	WF0735	WF0736
Tank:	10.2 gal	6.2 gal
Rated Power:		2 HP
Maximum Power:		2.5 HP
Motor:		Lubricated
Air Flow:	4.8 CFM @ 40 PSI / 4.0 CFM @ 90 PSI	3.5 CFM @ 40 PSI / 2.5 CFM @ 90 PSI
Continuous Flow:	136 L / min	101 L / min
Speed:		3 400 rpm
Work Cycle:	8 hrs max. per day / (DO NOT EXCEED 4 LOADS PER HOUR)	
Weight:	27 Kg	23.6 Kg
Inner:		1
Master:		1
Packaging:	Box	

AIR COMPRESSOR KIT

- 120 V~ single-phase
- Double pressure gauge-2 air outputs with quick connection
- Air filter included
- Drain valve
- 2 pneumatic wheels
- Speed: 3,400 rpm

Wolfox



CONTAINS
WF0735 horizontal air compressor 2 Hp 40 Lts
TC3044 hose for low pressure air 5m
TC1838 gravity gun for painting, general purpose
WF0153 set of couplings and quick connectors 5 pcs
* NOTE: All packed in a single box

NOM



40 L

WF0735K

WARRANTY
1 YEAR
WARRANTY



Wolfox



All compressors have high and low pressure output. Large pressure gauge shows high pressure output and the small adjustable gauge pressure shows low-pressure output. Use oil SAE 40.

WARNING

This equipment MUST BE USED with a 115V to 125V Power Supply, using a DIFFERENT VOLTAGE WILL SEVERLY DAMAGE the product.



NOM

24 L

WF0736K

WARRANTY
1 YEAR
WARRANTY



Code	WF0735K	WF0736K
Tank:	10.2 gal	6.2 gal
Rated Power:		2 HP
Maximum Power:		2.5 HP
Motor:		Lubricated
Air flow:	4.8 CFM @ 40 PSI / 4.0 CFM @ 90 PSI	3.5 CFM @ 40 PSI / 2.5 CFM @ 90 PSI
Continuous Flow:	136 L / min	101 L / min
Speed:		3 400 rpm
Workload:	8 hrs max. per day / (DO NOT EXCEED 4 LOADS PER HOUR)	
Weight:	27 Kg	23.6 Kg
Inner:		1
Master:		1
Packaging:	Box	

POWER TOOLS | BRUSH CUTTERS



These easy-start brush cutters are ergonomically designed for a fast and efficient use and ideal for trimming grass or weeds.

2-stroke engine:

Warning!

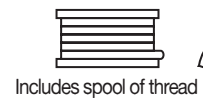

Includes spool of thread

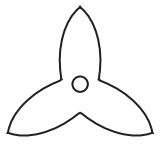

Includes blade

SHAFT TRIMMER, GAS-POWERED ENGINE

- Bike-type handle (two hands) with safety switch and lock
- Comfortable load harness
- Useful for cutting lawn, grass and brush
- Clutch included



Warranty is subject to prior CSA assessment.



WARRANTY 1 YEAR

Code	TC5338	TC5371	TC5370	TC5369
Motor Capacity:	63 c.c. / 2.7 HP	50 c.c. / 1.8 HP	43 c.c. / 1.5 HP	33 c.c. / 1.2 HP
Cut Diameter:	18"			
Tank Capacity:	1.3 L	1.1 L	1 L	
Thread diameter:	2.0 mm, 2.4 mm, 2.7 mm, 3.3 mm			
Weight:	8 Kg	7.9 Kg	7.4 Kg	6.4 Kg
Workload:	1 tank x 30 min of rest. Maximum daily: 8 hrs			
Inner:	1			
Master:	1			2

Packaging: Box

SHAFT TRIMMER, GAS-POWERED ENGINE

- Automatic reel with thread adjustment
- Useful for cutting lawn, grass and brush
- Clutch included



WARRANTY 1 YEAR

WARRANTY 1 YEAR

2-stroke engine:

Warning!



Code	TC5337	TC5368
Motor Capacity:	1 HP	
Cut Diameter:	17"	
Handle Type :	Straight handle "D" type	Curved "D" type
Tank Capacity:	500 mL	
Thread diameter:	2.0 mm, 2.4 mm, 2.7 mm, 3.3 mm	
Weight:	6.5 Kg	5 Kg
Workload:	1 tank x 30 min of rest. Maximum daily: 8 hrs	
Inner:	1	
Master:	1	

Packaging: Box

SPARE PARTS



Code	Spare parts	Compatible Model	Inner	Master
TC5338CR	Shaft trimmer reel	TC5338/TC5371	1	100
TC5338CU	Shaft trimmer cover	TC5338/TC5371	1	100
TC5338R	Shaft Trimmer retainer	TC5338/TC5371	1	100
TC5337CR	Shaft trimmer reel	TC5337/TC5368	1	100
TC5337CU	Shaft trimmer cover	TC5337/TC5368	1	100
TC5337R	Shaft Trimmer retainer	TC5337/TC5368	1	100

Packaging: Box

ADDITIVES



Code	Spare Parts	Inner	Master
TC5407	2-stroke engine oil 118 ml (4oz)	6	24
TC5406	Carburetor cleaner 470 ml	1	12

Packaging: Box

33 CC, 18" SHAFT TRIMMER MULTIFUNCTION 4-IN-1, GAS-POWERED ENGINE

- "D" handle
- Gasoline tank capacity: 1 liter
- Suggested thread diameter: 2.0 mm, 2.4 mm, 2.7 mm, 3.3 mm
- Includes spool of thread, blade, chain saw and hedge trimmer blade
- Weight: 14.2 kg
- Includes load harness
- Useful for cutting lawn, grass, brush, branches and logs
- Clutch included

Workload:
1 tank x
30 min of rest
Maximum daily: 8 hrs



WARRANTY
1 YEAR

Warranty is subject to prior CSA assessment

Warning!



2-stroke engine: Mix 20 ml of oil and 1 liter of gasoline in 1 tank only

Code	Engine Capacity	Cutting diameter	Inner	Master
TC5339	33 c.c. / 1.2 HP	18"	1	1
Spare Parts				
TC5338CR	Shaft trimmer reel		1	100
TC5338CU	Shaft trimmer cover		1	100
TC5338R	Shaft Trimmer retainer		1	100
Additives				
TC5407	2-stroke engine oil 118 ml (4oz)		6	24
TC5406	Carburetor cleaner 470 ml		1	12

Packaging: Box

NYLON THREAD FOR BRUSHCUTTER

- Impact resistant
- Available in roll and blister packaging
- Can be used on electric brush cutter and gas-engine to cut grass plants and lawn



Cross-head type wire



Code	Color	Diameter	Length	Inner	Master
Roll					
TC3212	Green	2 mm	120 m	4	32
TC3213	Orange	2.4 mm	78 m	4	32
TC3214	Red	2.7 mm	63 m	4	32
TC3215	Yellow	3.3 mm	48 m	4	32
Blister					
TC3216	Blue	1.65 mm	15 m	12	72
TC3217	Green	2 mm	15 m	12	72
TC3218	Orange	2.4 mm	12 m	12	72
TC3219	Red	2.7 mm	12 m	12	72

Packaging: Blister and Roll

ELECTRIC TRIMMER

- 120 V - 60 Hz
- Useful for cutting lawn grass and for garden maintenance



Code	TC3211	TC3210	WF9892
Cutting diameter:	12"	10"	
Speed:		10 000 rpm	
Thread diameter:		1.20 mm - 1.65 mm	
Handle:		"D" Type	
Workload:	20 min of work x 15 min of rest. Maximum daily: 3 hrs.		15 min of work x 10 min of rest. Maximum daily: 1.5 hrs.
Telescopic tube:	Adjustable by section		No
Inner:		1	
Master:	4		6

Packaging: Box

SPARE PARTS



Code	Spare Parts	Inner	Master	Code	Spare Parts	Inner	Master
TC3211CR	Shaft trimmer reel	3	100	TC3210CR	Shaft trimmer reel	1	200
TC3211CU	Shaft trimmer cover	1	100	TC3210CU	Shaft trimmer cover	12	200

Packaging: Box

Packaging: Box

GAS ENGINE GENERATORS

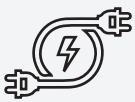

These are ideal to be used at home, in the country, to have electricity in areas of work in general, for the operation of electrical appliances.

4-stroke engine: gasoline and oil are supplied in separate tanks. Add oil before starting the engine.

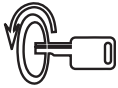

Key ignition system

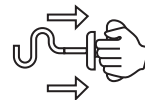

Manual ignition system



Overload protection



Low oil level sensor

2-stroke engine:

Warning!



Code	TC3419	TC3418	TC3136	TC3134
Rated Power	7 500 W	5 500 W	2 500 W	900 W
Maximum output: 120 Vac	3 500 W	3 000 W	2 500 W	900 W
Maximum output: 240 Vac	7 500 W	5 500 W	NA	NA
Maximum power:	50 A	40 A	19 A	8 A
Frequency:	60 Hz			
Speed without load:	3 600 rpm			
Engine power:	15 HP	13 HP	6.5 HP	2 HP
Starting system:	Electric ignition (switch with key) and manual (retractable rope)	Manual (retractable rope)	Manual (retractable rope)	Manual (retractable rope)
Continuous work cap:	8 hrs.	9 hrs.	3 hrs.	2 hrs.
Overload protection	YES			
Weight:	103 Kg	82 Kg	41 Kg	18 Kg
Tank:	25 L		15 L	4.2 L
Workload	1 Tank x 30 min of rest			1 Tank x 30 min of rest
Frame:	Metal frame with 10" pneumatic wheels		Metal	
Receptacles	<p>The connection of 12 V CD serves to give charge to automotive batteries</p> <p>3 contacts of 120 V ~ 1 contact of 240 V ~</p>	<p>The connection of 12 V CD serves to give charge to automotive batteries</p> <p>2 contacts of 120 V ~ 1 contact of 240 V ~</p>	<p>The connection of 12 V CD serves to give charge to automotive batteries</p> <p>2 contacts of 120 V ~</p>	<p>The connection of 12 V CD serves to give charge to automotive batteries</p> <p>1 contacts of 120 V ~</p>
Inner:	1			
Master:	1			
Recommendations	<ul style="list-style-type: none"> Change the oil every 50 hours of work Use unleaded gasoline 			<ul style="list-style-type: none"> Use unleaded gasoline
Additives	TC5406 Carburetor cleaner 470 ml (8 oz) Inner 1 / Master 12			TC5407 2-Stroke Engine Oil 118 ml (4 oz) Inner 6 / Master 24
Packaging:	Box			

**2,900 PSI 7HP
GAS HIGH PRESSURE WASHER**

- Tank capacity: 3 L
- Solid wheels for easy movement
- 8m high pressure hose
- 5 interchangeable nozzles
- Weight: 30 kg
- 2.5 hours of continuous work x tank
- Low oil level sensor
- Includes front tank for shampoo application

Add oil before using it for the first time (SAE-10W30)

Workload:
1 Tank x
20 min of rest



! 4-stroke engine: gasoline and oil are supplied in separate tanks

Warranty is subject to prior CSA assessment.

Code	Engine Power	Maximum flow	Maximum Pressure	Inner	Master
TC5204	5,215 W / 7 HP	7.5 L/min	2,900 PSI	1	1
	Additives		Content		
TC5406	Carburetor cleaner		470 ml (8 oz)	1	12

Packaging: Box

ACCESSORIES FOR PRESSURE WASHERS

Code	Spare Parts	Inner	Master
TC2508F	High pressure washer filter	1	100
TC2508L	Lancet high pressure washer	1	100
TC2508M	High-pressure washer hose	1	50
TC2508P	High-pressure washer gun	1	100
TC3574F	High pressure washer filter	1	100
TC3574L	Lancet high pressure washer	1	100
TC3574M	High-pressure washer hose	1	100
TC3574P	High-pressure washer gun	1	100
WF0612F	High pressure washer filter	1	100
WF0612L	Lancet high pressure washer	1	100
WF0612P	Pistola hidrolavadora	1	100
WF0612M	High-pressure washer hose	1	100
TC5204F	High pressure washer filter	1	50
TC5204L	Lancet high pressure washer	1	50
TC5204M	High-pressure washer hose	1	50
TC5204P	High pressure washer	1	50

Packaging: Box

VERTICAL HIGH PRESSURE WASHER

- 127 V~ 60Hz
- Automatically stops when no liquid flow is detected
- 5 m hose



2 000 PSI



1740 PSI



1740 PSI

Code	TC2508	TC3574	WF0612
Power:	1600 W / 2,2 HP	1,350 W / 2 HP	1,500 W / 2 HP
Maximum flow:	7.5 L/min		
Engine:	Induction	Carbons	
Water supply system:	Faucet or still water	-	Faucet or still water
Workload	40 min of work x 20 of rest. Maximum daily: 6 hr.		30 min of work x 20 of rest. Maximum daily: 3 hr
Includes	Internal tank mixer of liquid soap/ Ajustable gun/ Thermal protector	Spare carbon brushes / Soap-mixing container	Soap-mixing container
Inner:	1		
Master:	1		

Packaging: Box

POWER TOOLS | CHAINSAWS



Toolcraft chainsaws are efficient, lightweight, and very easy to start and maneuver. Made for the most demanding jobs.



Easy start system

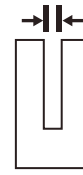

0.058" (1.47 mm) chain gauge

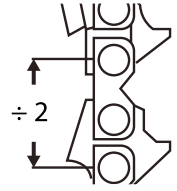

0.325" (8.25 mm) chain weight

GAS ENGINE CHAINSAWS

- 2-stroke gasoline engine
- Greater performance for precise and fast cuts



2-stroke engine:

Warning!



Wolfax

NEW PRODUCT



	58 c.c.	45 c.c.	45 c.c.	45 c.c.	45 c.c.	45 c.c.
Code	TC3886	TC3417	TC3416	TC3885	WF0859	WF0860
Power	3.3 HP	2.4 HP	2.4 HP	2.4 HP	2.3 HP	
Bar size	22"	20"	18"	16"	20"	18"
Max. Speed	11 000 rpm				10 500 rpm	
Tank Capacity	550 ml					
Workload	1 Tank x 30 min. of rest. Maximum Daily: 6 hrs.				1 Tank x 30 min. of rest	
Inner	1					
Master	2				4	
Additives	TC5407 2-stroke engine oil 118 ml (4 oz) Inner 6 / Master 24 TC5406 Carburetor cleaner 470 ml (8 oz) Inner 1 / Master 12					
Accessories	Includes: Dosing canister for fuel mixture, guard, and installation kit These products do not generate VAT					

Chain: greater performance for precise and fast cuts.
Compatible only with Toolcraft chainsaws.
Registered trademark of Blount, Inc.



ACCESSORIES FOR CHAINSAWS

CHAINS

Wolfax

NEW PRODUCT



Code	Accessory	Bar size	Inner	Master
TC3890	Chain	22"	1	50
TC3445	Chain	20"	1	50
TC3444	Chain	18"	1	50
TC3889	Chain	16"	1	50

Packaging: Blister

Packaging: Blister

BARS



Code	Accessory	Bar size	Inner	Master
TC3888	Bar	22"	1	20
TC3443	Bar	20"	1	20
TC3442	Bar	18"	1	20
TC3887	Bar	16"	1	20

Packaging: Blister

RETRACTABLE SYSTEM



NEW PRODUCT

Code	Accessory	Inner	Master
TC5537	Fully retractable system	1	100

Packaging: Bag

45 CC CHAINSAW, GAS-POWERED ENGINE, 18"

- 2-stroke gasoline engine
- Quick brake handle
- Easy start system
- Chain passage: 0.325" (8.25 mm)
- Chain gauge: 0.058" (1.47 mm)
- Tank capacity: 550 ml
- Speed: 3,000 - 11,500 rpm

NEW PRODUCT

WARRANTY 1 YEAR



INCLUDES



Oregon® Chain, Chain, Bar, Installation kit and Dosing canister for fuel mixture.



Workload:
15 min workload
x 5 min of rest

2-stroke engine:
Warning!



OREGON

Chain: greater performance for precise and fast cuts.

NOM

45 c.c.

Code	Engine Capacity	Bar size	Inner	Master
TC5602	24 HP	18"	1	2

Packaging: Box/ All packed in a single Box

26 CC CHAINSAW, GAS-POWERED ENGINE

- For cutting shrubs and hedges
- Dual anti-vibration blade system
- Blades with double edge on both sides
- Gas tank capacity: 0.5 liters
- Manual start (retractable rope)
- Weight: 5.7 kg
- Clutch included

Workload:
1 tank x
20 min rest
Maximum daily: 6hrs



Warranty is subject to prior CSA assessment.

WARRANTY 1 YEAR



Warning!



2-stroke engine: Mix 20 ml of oil and 1 liter of gasoline in 1 tank only

Code	Engine capacity	Cut length	Speed	Inner	Master
TC5340	26 c.c. / 0.9 HP	60cm	7,500 rpm	1	1
Additives		Content			
TC5407	2-stroke engine oil	118 ml (4 oz)	6	24	
TC5406	Carburetor cleaner	470 ml	1	12	

Packaging: Box

1,900 W, 18" ELECTRIC CHAINSAW

- Quick brake handle
- Easy start system
- Chain passage: 0.375 "(9.52 mm)
- Chain gauge: 0.050 "(1.27 mm)
- Speed: 7,000 rpm

Workload:
30 min workload
x 5 min of rest

NEW PRODUCT

WARRANTY 2 YEARS



OREGON

Chain: greater performance for precise and fast cuts.

NOM



Code	Engine Capacity	Bar size	Inner	Master
TC5586	1,900 W	18"	1	2
Accessories				
TC4590	Chain	18"	1	50
TC4591	Bar	18"	1	20

Packaging: Box (TC5586), blister (spare parts- TC4590 y TC4591)

43 CC MINI PLOW MACHINE GAS-ENGINE

- Manual start (retractable rope)
- Grips with plastic lining
- Hardness on gearwheels: 30-40 HRC
- Clutch included
- Gas tank capacity: 1.1 liters
- Weight: 15 kg

Workload:
1 tank x
10 min of rest
Maximum daily: 8 hrs



WARRANTY 2 YEARS

Warranty is subject to prior CSA assessment



Warning!



2-stroke engine: Mix 20 ml of oil and 1 liter of gasoline in 1 tank only

Code	Engine Capacity	Speed	Depth of tillage	Inner	Master
TC5341	43 c.c. / 1.7 HP	9,300 rpm	10cm	1	1
Additives		Content			
TC5407	2-stroke engine oil	118 ml (4 oz)	6	24	
TC5406	Carburetor cleaner	470 ml	1	12	

Packaging: Box

196CC SPRAYING MACHINE GAS-ENGINE

- Includes 2 strong wheels of 6" and 2 pneumatic tires of 10"
- 14 - 221 pm
- Manual ignition (retractable rope)
- PVC hose, length: 50 m
- Steel lance
- Gas tank capacity: 3.6 liters
- Weight: 46 kg

Warranty is subject to prior CSA assessment

Workload:
1 tank x
20 min of rest
Maximum daily: 8 hrs

Warning! Motor a 4 tiempos: la gasolina y el aceite se suministran en depósitos separados



WARRANTY 1 YEAR

GAS-ENGINE SPRINKLER 25CC, 25L

- Polyethylene tank
- Plastic hose
 - Length: 1.5 m
 - Internal diameter: 7 mm
- Manual ignition (retractable rope)
- Maximum pressure: 2.5 PSI
- Stainless steel lance
- Stainless steel nozzle
- Gas tank capacity: 0.75 liters
- Weight: 10 kg
- Includes load harness

Warranty is subject to prior CSA assessment

Workload:
1 Tank x
10 min of rest
Maximum daily: 6 hrs



Warning!



2-stroke engine: Mix 20 ml of oil and 1 liter of gasoline in 1 tank only

Code	Engine capacity	Sprinkler tank capacity	Speed	Inner	Master
TC5343	25 c.c. / 1 HP	25 litros	7,500 rpm	1	1
Additives		Content			
TC5407	2-stroke engine oil	118 ml (4 oz)	6	24	
TC5406	Carburetor cleaner	470 ml	1	12	

Packaging: Box

GASOLINE MOTOR BLOWER 43CC

- For cleaning parks, parking lots, terraces, gardens, etc
- Manual ignition (retractable rope)
- Variable speed
- Polyethylene tube and nozzle
- Includes load harness
- Weight: 8.2 kg
- Gas tank capacity: 1 liter
- Pipe / Nozzle
- Total length: 1.55 m
- Diameter: 7cm

Warranty is subject to prior CSA assessment

Workload:
1 tank x
10 min of rest
Maximum daily: 6 hrs



WARRANTY 1 YEAR

Warning!



2-stroke engine: Mix 20 ml of oil and 1 liter of gasoline in 1 tank only

Code	Engine capacity	Air flow	Speed	Inner	Master
TC5342	43 c.c. / 1.7 HP	530 CFM	7,000 rpm	1	1
Additives		Content			
TC5407	2-stroke engine oil	118 ml (4 oz)	6	24	
TC5406	Carburetor cleaner	470 ml	1	12	

Packaging: Box

POWER TOOLS | CUTTERS | GRINDERS

14", METAL CIRCULAR SAW, 2,250 W

- 120 V- 60 Hz
- Includes 14" disc
- Press on the base that holds the material for a good cut
- Easy access to disc
- "D" handle for better grip and greater safety
- Cutting capacity at 90°: 4 1/2"
- Cutting capacity at 45°: 4 1/2"
- Complete guard for greater security
- Includes installation key
- Spare carbon brushes included

Workload:
40 min of work x
20 min of rest
Maximum daily: 3 hr



WARRANTY
2 YEARS
WARRANTY

D-handle for better grip

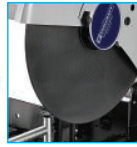

Retractable guard 3/4"



Clamping press for precise cuts

NOM

Code	Diameter	Axis	Power	Speed	Inner	Master
TC4470	14"	1"	2,250 W	3,800 rpm	1	1

Packaging: Box

4 1/2", TILE CIRCULAR SAW, 1,200 W

- Hose and valve for wet cutting
- Cuts up to 45°
- Includes continuous rim diamond cutting blade
- Safety switch button
- Adjustable base for 45° cuttings
- For cutting of tile, ceramics, marble and quarry
- 120 V- 60 Hz



NOM

Code	Diameter	Axis	Power	Speed	Inner	Master
TC3441	4 1/2"	7/8"	1,200 W	11,000 rpm	1	6

Packaging: Box

BENCH GRINDER

- 120V- 60Hz
- With two metal grinding wheels
- Protecting guard for safety
- With two 60 grit (medium) and 36 grit (coarse) metal grinding wheels

WARRANTY
2 YEARS
WARRANTY



NOM

WARRANTY
1 YEAR
WARRANTY



NOM

	560 W	200 W	375 W	185 W	120 W
Code	TC4471	TC1963	TC1975	TC5261	WF9363
Wheel:	8"	6"		5"	
Power:	3/4 HP	1/3 HP	1/2 HP	1/4 HP	1/6 HP
Axis:	5/8"		1/2"		
Speed:	3 550 rpm		3 450 rpm		3 550 rpm
Workload:	30 min of work x 15 min of rest Maximum daily: 6 hr	30 min of work x 15 min of rest Maximum daily: 6 hr			15 min of work x 10 min of rest Maximum daily: 3 hr
Inner:	1				
Master:	1		4		

Packaging: Box

POLISHER

- 120V- 60Hz
- Variable speed trigger type switch
- Axis lock
- Velcro backrest
- Includes wool bonnet and hexagonal wrench
- Soft touch handle
- Variable speed
- Spare carbon brushes included

WARRANTY
2 YEARS
WARRANTY



NOM

- 120 V- 60Hz
- Diameter of 10" (254 mm)
- Double grip support
- Includes wool bonnet: Front: 100% wool Back: 100% cotton

WARRANTY
1 YEAR
WARRANTY



NOM

Wolfbox

Code	TC5469	WF9367
Power:	1 260 W	110 W
Diameter:	7"	10"
Speed:	1 000 - 3 600 rpm	3 000 rpm
Axis:	5/8"	
Workload:	30 min of work x 15 min of rest Maximum daily: 3 hrs	20 min of work x 15 min of rest Maximum daily: 1.5 hrs
Inner:	1	
Master:	4	

SPARE PARTS FOR POLISERS

Code	Accessories	Inner	Master	Code	Accessories	Inner	Master
TC2729	7" Bonnet	5	20	WF9657	10" Bonnet	5	100
TC2730	7" Velcro backrest	2	20				

Packaging: Box (TC5469) / Bag (TC2729, TC2930)

Packaging: Box (TC5469) / Bag (TC2729, TC2930)

9" INDUSTRIAL ANGLE GRINDER

- 120V~ 60 Hz
- Soft touch handle
- Axis block for fast wheel change
- Safety trigger switch
- 3 positions of auxiliary handle
- Key included
- Includes spare carbon brushes



Workload:
50 min of work x
20 min of rest
Maximum daily: 6 hrs



NOM

2 300 W

Code	Diameter	Axis	Power	Speed	Inner	Master
TC4473	9"	5/8"	2,300 W	6,000 rpm	1	2
Spare Parts						
TC4473C	Carbon brush angle grinder				1	50

Packaging: Box

4 1/2" INDUSTRIAL ANGLE GRINDER

- 120V~ 60 Hz
- Soft touch handle
- Axis block for fast wheel change
- Safety trigger switch
- 3 positions of auxiliary handle
- Key included
- Includes spare carbon brushes



Workload:
50 min of work x
20 min of rest
Maximum daily: 6 hrs



NOM

900 W

Code	Diameter	Axis	Power	Speed	Inner	Master
TC4472	4 1/2"	5/8"	900W	11,000 rpm	1	6
Spare Parts						
TC4472C	Carbon brush angle grinder				1	100

Packaging: Box

7" ANGLE GRINDER

- 120V~ 60 Hz
- Soft touch handle
- Axis block for fast wheel change
- Safety trigger switch
- 3 positions of auxiliary handle
- Key included
- Includes spare carbon brushes



NEW PRODUCT

Workload:
30 min of work x
15 min of rest
Maximum daily: 3.5 hrs



NOM

1 900 W

Code	Diameter	Axis	Power	Speed	Inner	Master
TC5478	7"	5/8"	1,900 W	6,000 rpm	2	2

Packaging: Box

4 1/2" ANGLE GRINDER

- 120V~ 60Hz
- Soft touch handle
- Axis block for fast wheel change
- 2 positions of auxiliary handle



NOM

1 200 W

Code	TC5477	TC5476	TC5476K
Diameter:		4 1/2"	
Axis:		5/8"	
Speed:		12 000 rpm	
Workload:	30 min of work x 15 min of rest. Maximum daily: 3 hrs		
Includes:	Disc/ Key / Spare Carbon brushes	5 extra discs: 3 discs thin metal cutting TC1903 2 metal roughing discs TC1908 / Key / Spare Carbon brushes	
Inner:		1	
Master:		6	
Packaging:	Box		



NOM

900 W



900 W

4 1/2" ANGLE GRINDER

- 120V~ 60Hz
- Soft touch handle
- Axis block for fast wheel change
- 2 positions of auxiliary handle



NOM

710 W



NOM

710 W

Wolfox



NOM

500 W

Code	TC5525	WF0780	WF0779
Diameter:		4 1/2"	
Axis:		5/8"	
Speed:		11 000 rpm	12 000 rpm
Workload:	30 min of work x 15 min of rest. Maximum daily: 3 hrs		20 min of work x 15 min of rest. Maximum daily: 3 hrs
Usage:	Semi Industrial		Household use
Included:	Disc/ Key / Spare Carbon brushes		Disc/ Key / Spare Carbon brushes
Inner:		1	
Master:	6	8	6
Packaging:	Box		

POWER TOOLS | JIGSAWS | SANDERS

INDUSTRIAL JIG SAW

· 120V~60Hz



750 W

JIG SAW

· 120V~60Hz



NOM



800 W

NOM



WARRANTY
2 YEARS

NOM

570 W

Wolfox

WARRANTY
1 YEAR



NOM

450 W

Code	TC4478	TC5480	TC5479	WF0781
Speed:	800 - 3 000 rpm			3 000 rpm
Cutting capacity:	Wood 90° - 100 mm/ Metal 90° - 10 mm	Wood 90° - 100 mm/ Metal 90° 6 - 10 mm	Wood 90° - 65 mm/ Metal 90° 8 mm	Wood 90° - 55 mm/ Metal 90° 6.5 mm
Laser guide:	Yes			-
Workload:	50 min of work x 20 min of rest. Maximum daily: 6 hrs	30 min of work x 15 min of rest. Maximum daily: 3 hrs		20 min of work x 15 min of rest. Maximum daily: 1.5 hrs
Stroke length:	-	11/16" (17.46 mm)	11/16" (17.46 mm)	-
Variable speed	Yes			-
Guiding bar:	Yes			-
Blade shark:	Type "T"			Type "U"
Blade change:	Yes, no tools needed		Yes	
Includes:	Blade / Spare carbon brushes		Key / Blade / Spare carbon brushes	
Inner:	1		2	
Master:	4		10	
Packaging: Box				

BELT SANDER

- Variable speed
- With safety button



1 010 W

NOM

FINISHING SANDER

- Two-finger trigger



400 W

NOM



180 W

NOM



150 W

NOM

- Sealed switch for longer life

WARRANTY
2 YEARS

- Double grip support
- Dust outlet

Wolfox
WARRANTY
1 YEAR

Code	TC5482	TC3431	TC3432	WF9652
Speed:	200 - 300 m/min	14 000 rpm	10 000 rpm	9 500 rpm
Sanding surface:	3" x 21" (76.2 mm x 533.4 mm)	1/2 blade: 4 1/2" x 9" (114.3 mm x 228.6 mm)	1/4 blade: 4 1/4" x 4 1/2" (107.95 mm x 114.3 mm)	1/3" blade: 3 1/2" x 7 3/8" (90 x 187 mm)
Voltage / Frequency:	120V~60Hz			
Grip:	Soft touch and support handle	Soft touch handle with double grip support	-	-
Workload:	40 min of work x 20 min of rest. Maximum daily: 6 hrs		20 min of work x 15 min of rest. Maximum daily: 3 hrs	20 min of work x 15 min of rest. Maximum daily: 1.5 hrs
Continuous work button:	-		Yes	
Includes:	Collection bag/ Spare carbon brushes	Spare carbon brushes	Collection Bag/ Spare carbon brushes	-
Inner:	1		2	
Master:	4		10	
Packaging: Box				

3 1/4" ELECTRIC PLANER, 700 W

- 120V - 60Hz
- Mounted on a ball bearing
- Fine depth brushing adjustment
- Handle with soft grip
- Parallel guide
- Includes bag and key
- Spare carbon brushes included

Workload:
25 min of work x
15 min of rest
Maximum daily: 3 hrs



WARRANTY
2 YEARS
WARRANTY

NOM

Code	Power	Speed	Inner	Master
TC3440	700 W	16,000 rpm	1	6

Packaging: Box

MULTITOOL ACCESSORIES

- (1) Cuttings in plaster wall, PVC, aluminum and copper. Thickness: 0.8mm
- (2) Cuttings in wood, plastic and non-ferrous metals. Thickness: 0.6
- (3) Roughing of wood and non-ferrous metals. Grit: 30-40
- (4) Sanding wood, plastic and non-ferrous metals. Grit: 2 pcs each 60/80/120/240
- (5) Pad to place the sandpaper.
- (6) To remove paint, adhesives and carpets. Thickness: 0.8mm
- (7) To remove cement, plaster and fillings Thickness: 1mm

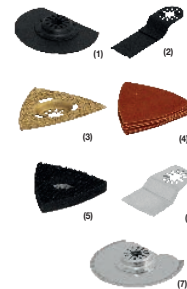

Code	Product	Size	Inner	Master
TC5312	(1) Semicircular saw blade	3 1/2"	10	100
TC5313	(2) Blade for cutting	1 1/4"	6	120
TC5311	(3) Tungsten carbide rasp	78 mm x side	6	120
TC5316	(4) Sandpaper set 8 pcs	78 mm x side	6	120
TC5310	(5) Sanding pad	80 mm x side	6	120
TC5314	(6) Scrape blade	2"	6	120
TC5315	(7) Remove grout blade	3 1/2"	5	100
TC5317	Accessories set (1, 2, 4, 6)		4	40

Packaging: Blister

MULTITOOL WITH ACCESSORIES 300 W

- 120V - 60Hz
- Variable Speed
- Includes case and 5 accessories:
 - Saw blade
 - Blade type shovel
 - Hexagonal key
 - Paper and sandpaper for metal and wood
- For sanding, cutting, polish, scrape, remove painting, jobs in wood, pipe cuts PVC and cuts in plaster panels.
- Spare carbon brushes included

Workload:
30 min of work x
15 min of rest
Maximum daily: 3 hrs



WARRANTY
2 YEARS
WARRANTY

NOM

Code	Power	Variable Speed	Inner	Master
TC4486	300 W	15,000 to 22,000 rpm	1	6

Packaging: Box

MOTOTOOL 1/8", 150 W

- 120V - 60Hz
- 2 m power cord
- Collet: 1/8 "(3.1 mm)
- Variable speed
- Clamping hook
- Includes case and 40 accessories
 - For grinding and roughing metal, polishing, cutting, sharpening, brushed, pyrographed, sanding and engraved
 - Spare carbon brushes included
 - Includes extension pencil-type

Workload:
30 min of work x
15 min of rest
Maximum daily: 3 hrs



WARRANTY
2 YEARS
WARRANTY

NOM

Code	Power	Variable Speed	Inner	Master
TC5448	150 W	10,000 to 36,000 rpm	1	10

Packaging: Plastic Box

HEAT GUN 1,700 W

- 120V - 60Hz
- Two-step switch
- Air flow:
 - 1st speed: 240 L/min
 - 2nd speed: 390 L/min
- Includes case and accessories (5 pieces)
- To thaw pipes, union of tarpaulins, remove paint, etc.

Workload:
30 min of work x
15 min of rest
Maximum daily: 3 hrs



WARRANTY
2 YEARS
WARRANTY

NOM

Code	Power	Temperature	Inner	Master
TC4049	1,700 W	45°C a 540°C	1	5

Packaging: Case

ROUTER



1 500 W

NOM



1 200 W

NOM

WARRANTY
2 YEARS
WARRANTY

Code	TC2753	TC3430
Diameter:	1/2"	1/4"
Speed:	6 000 to 26 000 rpm	4 000 to 30 000 rpm
Voltage / Frequency:	120 V - 60Hz	
Collet diameter:	1/2" (12.7 mm)	1/2" (12.7 mm)
Grip:	Soft Grip	
Depth adjustment:	Yes	
Security switch button:	Yes	
Workload:	30 min of work x 15 min of rest. Maximum daily: 3 hrs	
Includes:	Collet 1/4" (6.35 mm) / Spare carbon brushes	Spare carbon brushes
Inner:	1	
Master:	2	4

Packaging: Box



HAMMER DRILLS

INDUSTRIAL HAMMER DRILL 1/2"

- 120V~ 60Hz
- Variable speed
- Reversible function
- Two functions:
drill-hammer drill
- Depth guide
- Lock-on button for continuous operation



1 050 W



850 W

WARRANTY
2 YEARS
WARRANTY

NOM



PROFESSIONAL HAMMER DRILL 1/2"



1 000 W

WARRANTY
2 YEARS
WARRANTY

NOM



Code	TC4476	TC4475	TC5475
Drill bit:		1/2"	
Speed:	0 - 3 000 rpm		0 - 2 800 rpm
Reversible function:		Si	
Workload:	50 min of work x 20 min of rest. Maximum daily: 6 hrs		30 min of work x 15 min of rest. Maximum daily: 3 hrs
Handle:			Soft Touch
Includes:	Drill chuck key / Lateral handle / Spare carbon brushes		
Spare parts:	TC4476C Hammer drill carbons, Inner 1/Master 50	TC4475C Hammer drill carbons, Inner 1/Master 50	
Inner:		1	
Master:		6	
Packaging: Box			

HAMMER DRILL

- 120V~ 60Hz
- Variable speed
- Reversible function
- Two functions:
drill-hammer drill
- Depth guide
- Lock-on button for continuous operation



710 W



600 W

NOM



550 W

WARRANTY
2 YEARS
WARRANTY

Code	TC5474	TC5473	TC5472
Drill bit:		1/2"	3/8"
Speed:	0 - 2 600 rpm		0 - 3 000 rpm
Reversible function:		Yes	
Soft touch handle	Yes		-
Workload:	30 min of work x 15 min of rest. Maximum daily: 3 hrs		
Includes:	Drill Chuck Key / Lateral Handle / Spare carbon brushes		
Inner:		1	
Master:	6		10
Packaging: Box			

**HAMMER DRILL
3/8"**

- 120V~ 60Hz
- Variable speed
- Reversible function
- Lock-on button for continuous operation
- Includes chuck and lateral handle



Workload:
30 min of work x
15 min of rest
Maximum daily: 3 hrs



450 W



Code	Drill Bit	Speed	Power	Inner	Master
TC5484	3/8"	0 - 2,800 rpm	450 W	1	10

Packaging: Box

HAMMER DRILL

- 120V~ 60Hz
- Variable speed
- Reversible function
- Two functions:
drill-hammer drill
- Depth guide
- Lock-on button for continuous operation



500 W



500 W



Code	WF0778	WF0777
Drill Bit:	1/2"	3/8"
Speed:	0 - 3 000 rpm	
Workload:	20 min of work x 15 min of rest. Maximum daily: 1.5 hrs	
Includes:	Drill Chuck Key / Lateral Handle	
Inner:	1	
Master:	10	

Packaging: Box

CORDLESS HAMMER DRILL

- Variable speed
- Reversible function
- With LED light to work on dark areas
- Do not charge battery for more than 5 hours

Battery: Ni-Cd 1.2 Ah
Power: 40 W



18 V



Battery: Ni-Cd 1.2 Ah
Power: 38 W

18 V



18 V



Battery: Li-Ion 1.3 A
Power: 25 W

12 V



Code	TC4477	TC3423	WF9366
Function:	Drill - Hammer Drill	-	-
Drill bit:	1/2"	3/8"	3/8"
Speed:	0 - 1 250 rpm	0 - 550 rpm	0 - 650 rpm
Torque:	22 Nm	12 Nm	22 Nm
Torque positions:	21	16	8
Workload:	25 min of work x 15 min of rest. Maximum daily: 3 hrs		20 min of work x 10 min of rest. Maximum daily: 1.5 hrs
Includes:	120 V~ 60 Hz Charger / Lateral Handle	120 V~ 60 Hz Charger	120 V~ 60 Hz Charger/ 6 Bits / 6 Drill bits / 1 Adapted
Spare parts:	TC4477B / Battery hammer drill INNER 1/ MASTER 25 TC4477C / Charger hammer drill INNER 1/ MASTER 25	TC3423B / Battery hammer drill INNER 1/ MASTER 20 TC3423C / Charger hammer drill INNER 1/ MASTER 16	WF9366B / Battery hammer drill INNER 1/ MASTER 20 WF9366C / Charger hammer drill INNER 1/ MASTER 20
Inner:	1		10
Master:	4		10

Packaging: Box

CORDLESS SCREWDRIVER

- Variable speed
- Reversible function

LED light for working in dark areas



4.8 V



4.8 V



Code	TC3424	WF9651
Drill bit:	1/4"	
Speed:	0 - 180 rpm	
Torque:	2.5 Nm	
Torque positions:	16	
Drill bit adjustment:	Manual	
Workload:	20 min of work x 10 min of rest. Maximum daily: 1.5 hrs	
Includes:	120 V~ 60 Hz Charger / 22 Bits (25 mm) / 4 Extension bits / Two work positions / Articulated movement	120 V~ 60 Hz Charger / 11 Bits / 1 Extension bit
Inner:	2	
Master:	12	

Packaging: Blister

Drill Bit

- Tempered body and tip for major durability
- Chuck and key set
- Compatible with most commercial 3/8" and 1/2" drills and drill hammers



Code	Size	Inner	Master
Chuck and key set			
TC5538	3/8"	6	48
TC5539	1/2"	6	36
Key			
TC5540	3/8"	12	72
TC5541	1/2"	12	72

Packaging: Blister

POWER TOOLS | ELECTRIC HOISTS | COMPRESSORS | PAINT SPRAY GUNS

ELECTRIC HOIST

- Voltage 120 V~ / 60 Hz
- Includes pulley system and supports to suspend the hoist



	1 000 Kg	800 Kg	600 Kg	400 Kg	200 Kg
Code	TC3502	TC3501	TC3415	TC3414	TC5399
Load Capacity:	500 Kg / 1 000 Kg	400 Kg / 800 Kg	300 Kg / 600 Kg	200 Kg / 400 Kg	200 Kg / 100 Kg
Power:	1,700 W	1,350 W	1,050 W	745 W	460 W
Maximum lifting height:	12 m for loading of 500 kg 6 m for loading of 1,000 kg	12 m for loading of 400 kg 6 m for loading of 800 kg	12 m for loading of 300 kg 6 m for loading of 600 kg	12 m for loading of 200 kg 6 m for loading of 400 kg	12 m for loading of 100 kg 6 m for loading of 200 kg
Steel cable (thickness)	5.6 mm	5.0 mm	4.2 mm	3.6 mm	3 mm
Suggested cable for replacement	TC0989		TC0988		TC0986
Workload:	1 min of work x 9 min of rest. Maximum daily: 3 hrs				2 min of work x 8 min of rest. Maximum daily: 3 hrs
Inner:	1				
Master:	1		2		

Packaging: Box

12 V CD AIR COMPRESSOR

- Adapter for car 12 volts
- Manometer calibrator



Code	WF1010	WF1011
Maximum pressure:	300 PSI	
Emergency lamp	Yes	-
Cable:	2.5 m	2.7 m
Hose:	40 cm	-
Nozzle:	Adjustable 1.8 - 2.6 mm	-
Dispersion range:	25 cm	47 cm
Workload	20 min of work x 10 min of rest. Maximum daily: 1 hrs	
Includes:	3 adapters to inflate	-
Inner:	2	5
Master:	8	20

Packaging: Box

ELECTRIC PAINT SPRAYER

- 120V ~ 60 Hz
- 800 ml polypropylene cup
- Ergonomic handle



Code	TC5471	WF0598
Power	800 W	110 W
Max flow:	300 ml/min	350 ml/min
Adjustable Nozzle	Fan (Vertical /Horizontal/circular)	Fan
Paint Flow:	Adjustable	-
Nozzle:	Adjustable 1.8 - 2.6 mm	-
Dispersion range:	25 cm	-
Workload	30 min of work x 15 min of rest. Maximum daily: 1 hrs	-
Includes	1.8 m hose	-
Inner:	1	
Master:	4	5

Packaging: Box

12", COMPOUND MITER SAW TELESCOPIC ARM

- 120 V- 60 Hz
- Telescopic arm for up to 12" cut at 90°
- Extensions for better support of material
- Beveling at 45° (left and right)
- Base at 45° left and right
- 90° cutting capacity: 3 1/4" x 11 5/8"
- 45° cutting capacity: 1 3/4" x 11 5/8"
- Safety switch button
- Dust collection bag included
- Laser guide system



Laser included



NOM



Retractable guard 3/4

D-handle for better grip

Trim mark Beveled at 45° (left and right)



2 000 W

10", COMPOUND MITER SAW TELESCOPIC ARM

- 120V- 60Hz
- Telescopic arm for up to 10" cut at 90°
- Extensions for better support of material
- Beveling at 45° (left and right)
- Base at 45° left and right
- 90° cutting capacity: 3 1/4" x 11 5/8"
- 45° cutting capacity: 1 3/4" x 11 5/8"
- Safety switch button
- Dust collection bag included
- Laser guide system



Laser included



NOM



2 000 W

Code	TC4487	TC4636
Diameter	12"	10"
Speed	4 500 rpm	4 500 rpm
Axis	1"	5/8"
Workload	40 min of work x 20 min of rest. Maximum daily: 6 hrs	
Includes	Collection bag / 40 DP tungsten carbide blade for wood / Spare carbon brushes	
Inner:	1	
Master:	1	
Packaging: Box		

INDUSTRIAL CIRCULAR SAW

- 120 V- 60Hz
- 90° to 45° base tilt
- Angle cutting guide
- Lock-on button for continuous operation
- Metal guard
- Laser guide system
- Beveling at 45°
- 45° cutting capacity: 1 3/4
- 90° cutting capacity: 2 1
- Cooper Motor



Láser integrado



1 500 W

CIRCULAR SAW

- 120 V- 60Hz
- 90° to 45° base tilt
- Angle cutting guide
- Lock-on button for continuous operation
- Metal guard
- Laser guide system
- Beveling at 45°
- 45° cutting capacity: 1 3/4
- 90° cutting capacity: 2 1
- Cooper Motor



Láser integrado



1 200 W

Code	TC4479	TC1957
Diameter		7 1/4"
Speed	5 000 rpm	5 000 rpm
Axis		5/8"
Workload	50 min of work x 20 min of rest. Maximum daily: 6 hrs	30 min of work x 15 min of rest. Maximum daily: 3 hrs
Includes	Spare carbon brushes	
Inner:	1	
Master:	2	4
Packaging: Box		

900 W TIGER SAW

- 120 V- 60 Hz
- Hermetic seal to prevent dust
- Fast blade change system 1/4 turn
- 3 blades included: for wood, metal and plastic (10 - 14 dpd)
- Cutting capacity wood: 6" (150 mm)
- Cutting capacity metal: 4" (102 mm)
- Spare carbon brushes included



NOM



Code	TC4485		
Power	900 W		
Speed	2 500 rpm		
Workload	50 min of work x 15 min of rest. Maximum daily: 6 hrs		
Inner:	1		
Master:	4		
	Spare blades: 2 piece set	Inner	Master
TC4549	6" x 19mm	5	100
TC4550	9" x 19mm	5	100
TC4551	12" x 19mm	5	100
Packaging: Box			



STATIONARY MACHINES

EDGE BANDER

- 110 V / 220 V 60Hz
- Steel table top size:
- System for absorption of dust
- Steel Cabinet
- Cutting depth control system
- Support guide with an inclination of 45°-135°
- Power cable 18 AWG x 1.8 m



8", 1 1/2 HP



6", 1 HP

WARRANTY
2 YEARS
WARRANTY



Code	TC5424	TC5423
Cutting capacity (width)	203.2 mm	152.4 mm
Speed:	4 400 rpm	
Power:	1 110 W	750 W
Cutting capacity (slotted):	1/2"	
Work table:	1.525 m x 0.225 m (60 3/64" x 8 55/64")	1 m x 0.184 m (39 3/8" x 7 1/4")
Work cycle:	120 min of work x 30 of res, Maximum daily: 6 hr.	
Includes:	3 blades measuring 206 x 25 x 3 mm	3 blades measuring 154 x 18.6 x 2.5 mm
Inner:	1	
Master:	1	
Packaging:	Wooden box	

BANK PLANER 13", 2 3/4 HP

- 110 V - / 60Hz
- Cutting capacity: 13" (330 mm)
- Cutting thickness: 6 1/4 "
- Feed speed: 6 m / min
- Spindle speed: 8,000 rpm
- Work table: 13"x11 3/8 " (330x290 mm)
- Power cable: 16 AWG x 2 m

Workload:
2 hr of work x
30 min of rest
Maximum daily: 6 hr



WARRANTY
2 YEARS
WARRANTY

Code	Cutting capacity	Cuts per minute	Power	Inner	Master
TC5419	13" (330 mm)	16,000 cpm	2,000 W / 2 3/4 HP	1	1

Packaging: Box

TABLETOP SAW

110 V- / 60Hz



14", 1 1/2 HP



12", 1 HP



10", 1/2 HP



Code	TC5427	TC3448	TC5426
Power:	1 100 W	750 W	375 W
Speed:	400 - 480 m/min	370 - 800 m/min	730 m/min
Size:	355 mm	304 mm	245 mm
Table Size:	548 mm x 400 mm	480 mm x 400 mm	340 mm x 340 mm
Maximum cutting thickness:	230 mm	160 mm	100 mm
Table with inclination:	0° to 45°, 2 Speedes		0° to 45°, 1 Speed
Workload:	120 min of work x 30 min of rest. Maximum daily: 6 hrs		
Includes:	Tabletop saw: 2.56 m x 1/2" x 0.5 mm	Tabletop saw: 2.24 m x 3/8" x 0.5 mm	Tabletop saw: 1.712 m x 3/8" x 0.3 mm
Total measures, without bench:	Height: 1.26 m / Width: 56 cm / Lenght: 42 cm	Height: 1.12 m / Width: 49 cm / Lenght: 36 cm	Height: 88 m / Width: 42 cm / Lenght: 33 cm
Weight:	88 kg	75 kg	32 kg
Accessories:	-	TC3438 saw SC 2.24 m x 10 mm x 0.5mm x 6dpp Inner 1/Master 15	-
Inner:		1	
Master:		1	

Packaging: Box

**BAND SAW METALS
3/4 HP**

- 110 V- / 60Hz
- Circular cutting capacity: 5 1/2 "(114 mm)
- Cutting capacity: 45° to 90°
- 2 speeds: 21 m / min and 44 m / min
- Saw band size: 64 1/2 "x 1/2" x 0.76
- Power cable: 18 AWG x 1.8 m



Workload:
12 hr of work x
20 min of rest
Maximum daily:6 hr



Code	Power	Speed	Inner	Master
TC5428	550 W / 3/4 HP	1,780 rpm	1	1

Packaging: Box

90W JIG SAW WITH BENCH

- 120 V ~ / 60Hz
- Body made of cast iron
- Includes sawdust blower
- Work table: 16 5/16 "x 10" (415 x 250 mm)
- Blade length: 5 "
- Maximum cutting capacity: 2 "
- Power cable: 18AWG x 2 m
- Weight: 10 kg



Workload:
30 min of work x
15 min of rest
Maximum daily:6 hr



Code	Depth	Power	Speed	Inner	Master
TC5470	16"	90 W	400 - 1600 rpm	1	1

Packaging: Box

POWER TOOLS | STATIONARY MACHINES

TABLE SAW

- 110 V / 220 V 60Hz
- Scale for miter cutting

- 120 V / 60Hz
- Scale for miter cutting



10", 2.7 HP



10", 2 1/4 HP

Code	TC3447	TC5449
Type:	Floor	Portable
Power:	2 000 W / 2.7 HP	1 600 W / 2 1/4 HP
Speed:	3 400 rpm	4 800 rpm
Cutting capacity:	90°: 80 mm / 45°: 52 mm	90°: 76 mm / 45°: 63 mm
Work table:	With extensions: 27" x 40" (.686 m x 1.01 m) / Without extensions: 27" x 20"(0.68 x 0.508 m)	26" x 20" (0.66 x .50 m)
Workload:	120 min of work x 30 min of rest. Maximum daily: 6 hrs	30 min of work x 10 min of rest. Maximum daily: 6 hrs
Axis:	5/8"	
Includes:	40 DP tungsten carbide disc (for Wood)	
Inner:	1	
Master:	1	

Packaging: Box

7", 3/4 HP TABLE TILE CUTTER

- 120 V- 60 Hz
- Includes continuous rim diamond cutting blade
- Cutting capacity at 45° of 21 mm
- Cutting capacity at 90° of 34 mm
- Consumption: 4.8 A
- Ideal for thin cuts
- Graduated table
- With water container



Workload:
40 min of work x
20 min of rest
Maximum daily: 6 hr



Code	Diameter	Axis	Power	Speed	Inner	Master
TC4469	7"	5/8"	3/4 HP (600W)	3,500 rpm	1	1

Packaging: Box

BELT SANDER 4" AND DISC 6", 1/2 HP

- 110 V ~ / 60Hz
- Band measurement: 4 "x 36" (102 x 914 mm)
- Band speed: 5.6 m / min
- Disc size: 6 "(152 mm)
- Disc speed: 1,900 rpm
- Includes fixing guide on work table
- Working table inclination: 45 °
- Tilting band table: 90 °
- Power cable: 18 AWG x 1.8m



Workload:
50 min of work x
20 min of rest
Maximum daily: 6 hr



Code	Power	Speed	Inner	Master
TC5274	375 W / 1/2 HP	1,900 rpm	1	1

Packaging: Box

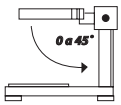

Work table inclinable

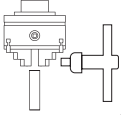

Drill Bit de Llave

FLOOR DRILL 5/8"

Voltage: 127~
Frequency: 60 Hz
Variable Speed

WARRANTY
2 YEARS

BENCH DRILL 1/2"

Voltage: 127~
Frequency: 60 Hz
Variable Speed

WARRANTY
2 YEARS

WARRANTY
1 YEAR

Wolfbox
NEW
PRODUCT



15", 1 HP

13", 3/4 HP



13", 3/4 HP



8", 1/3 HP



8", 1/3 HP

Code	TC5429	TC3449	TC3181	TC3139	WF0864
Power:	750 W	560 W	560 W	300 W	300 W
Drill Bit:	5/8"	5/8"	5/8"	1/2"	1/2"
Power consumption:	7.6 A	6.6 A	6.6 A	2.5 A	2.35 A
Speed:	12 220 - 3 600 rpm	16 220 - 3 600 rpm	12 300 - 2 900 rpm	5 760 - 3 070 rpm	
Working table:	11" x 11" (290 mm x 290 mm)	10" x 10" (254 mm x 254 mm)	10" x 10" (254 mm x 254 mm)	6 1/4" x 6 1/4" (160 mm x 160 mm)	6 1/4" x 6 1/4" (160 mm x 160 mm)
Total height:	163 cm	158 cm	99 cm	58 cm	58 cm
Workload:	60 min of work x 20 min of rest. Maximum daily: 6 hrs	50 min of work x 20 min of rest. Maximum daily: 6 hrs			30 min of work x 20 min of rest. Maximum daily: 6 hrs
Maximum depth:	80 mm	Maximum daily: 6 hrs	70 mm	50 mm	50 mm
Inner:	1				
Master:	1				

Packaging: Box

WELDING MACHINE

DOUBLE POWER SUPPLY VOLTAGE

- Knob to adjust the current, allows quick changes
- Primary connection board for voltage change

WELDING MACHINE



Transformer type Electric Arc Welders are very easy to start and maneuver. These can be used for a wide-variety of works since input parameters and voltage can be adjusted to output parameters for a specific purpose.



Code	TC4481		TC3307		TC2747		TC3508
Terminals:	3/8"		Yes				-
Workload:	20 % 2 min. of work x 8 min. of rest		10 % 1 min. of work x 9 min. of rest				
Power supply:	110 V 110V/68A/60Hz	220 V 220V/60A/60Hz	110 V 110V/68A/60Hz	220 V 220V/54A/60Hz	110 V 110V/68A/60Hz	220 V 220V/43A/60Hz	110 V 110V/68A/60Hz
Circuit Voltage:	110 V 78 VAC Step 1 58 VAC Step 2	220 V 78 VAC Step 1 58 VAC Step 2	110 V / 220 V 65 VAC		110 V / 220 V 50 VAC		110 V 48 VAC
Current range:	110 V 50 A 150 A CA Step 1 55 A 150 A CA Step 2	220 V 80 A 210 A CA Paso 1 55 A 250 A CA Paso 2	110 V 90 a 130 A CA	220 V 90 a 250 A CA	110 V 55 a 130 A CA	220 V 55 a 175 A CA	110 V 55 a 160 A CA
Power:	110 V 8.3 KVA	220 V 13.2 KVA	110 V 7.5 KVA	220 V 11.9 KVA	110 V 7.5 KVA	220 V 9.5 KVA	110 V 8 KVA
Phase:	Single Phase						
Works with electrodes:	6010: 1/8" (3.2 mm) / 6011: 1/8" (3.2 mm), 3/32" (2.4 mm) / 6013: 1/8" (3.2 mm), 5/32" (4 mm)						6013: 3/32" (2.4 mm), 1/8" (3.2 mm)
Work:	Industrial light duty			Light duty			
Includes:	-						Ground clamp / Electrode clamp / Ground cable 1.5 m #8 AWG / Electrode cable 2 m #8 AWG / Face shield / Brush
Accessories:	TC3525 Spare cables 250 A / Inner 1 / Master 6						
Inner:							1
Master:							1

Packaging: Box

INVERTER WELDER,

- Frequency 60 Hz
- Fine adjustment electronic current control
- Automatic arc control
- Quick entry terminals
- With thermal overload protector
- Ventilation cooling system

It can also use electrodes E5015, E5016, E4304 y E5003

NOM



WARRANTY
1 YEAR
WARRANTY

Code	TC5223	TC5222	TC4482
Voltage:	Automatic selection bi-voltage (120 / 260V~)		110 V
Coated electrode processes:	SMAW up to 5/32" and TIG		SMAW up to 5/32" and TIG
Terminals:	Yes, quick entry		
Workload:	50% 5 min. of work x 5 min. of rest	60% 6 min. of work x 4 min. of rest	20% 2 min. of work x 8 min. of rest
Power supply:	120 / 260 V ~	120 / 260 V ~	120 V ~
Input current:	42 A (260 V~)	32 A (260 V~)	14 A
Current range:	30 - 200 A	20 - 160 A	20 - 80 A
Power:	110 V 8.3 KVA	220 V 13.2 KVA	110 V 7.5 KVA
			220 V 9.5 KVA
Input rated capacity:	7 KW	5 KW	2.8 KW Circuit voltage 75 Vcc -
Works with electrodes:	120 V 6011 / 6013 / 7018: 3/32" 260 V 6011 / 6013 / 7018: 3/32", 1/8", 5/32"	120 V 6011 / 6013 / 7018: 3/32", 1/8" 260 V 6011 / 6013 / 7018: 3/32", 1/8", 5/32"	6011 / 6013: 3/32" 120 V
Work:	Industrial light duty		
Includes:	Ground clamp / Electrode clamp / Ground cable 5 m #6 AWG / Electrode cable 2 m #6 AWG / Face shield / Brush	Ground clamp / Electrode clamp / Ground cable 5 m #6 AWG / Electrode cable 2 m #6 AWG / Face shield / Brush	Ground clamp / Electrode clamp / Ground cable 1.5 m #7 AWG / Electrode cable 2 m #7 AWG / Face shield / Brush ...
Inner:		1	
Master:		1	
Packaging: Box			

**WELDER MICRO-WIRE,,
130 A CD**

- Knob for tap time control
- Integrated wire feeder
- With thermal overload protector
- Ventilation cooling system
- 4 voltage levels
- For MIG (GMAW) w / gas and MIG (FCAW) welding s / gas diameters from 0.6 to 0.9mm
- Reel capacity of 4 "diameter
- Industrial light duty

Includes cables, ground clamp, torch, face shield and brush to remove slag



Workload:
5 min of work x
8 min of rest

WARRANTY
1 YEAR
WARRANTY

20% Work cycle	
Power supply	120 V
Frequency	60 Hz
Current input	28 A
Current range	32 Vcc ~
Nominal Entry Capacity	5.7 KVA
Ground cable	1.5 m #5 AWG
Electrode Cable	2 m #5 AWG

Code	Amperage	Inner	Master
TC4483	130 A	1	1

Packaging: Box

POWER TOOLS | LATHE | CEMENT MIXER | WINCHS

WOOD COPYING LATHE 3/4 HP

- 110 V - / 60Hz
- Tipping measure: 13 3/4 "(350 mm)
- Distance between centers: 1 m
- 3 rollers
- Length of bed: 1 m
- Power cable: 16 AWG x 1.8 m

Workload:
120 min of work x
20 min of rest
Maximum daily: 6 hr



WARRANTY
2 YEARS



Code	Power	Roller speed	Inner	Master
TC5418	550 W / 3/4 HP	3,050 rpm	1	1

Packaging: Box

CEMENT MIXER, ELECTRIC

- 120 V- 60 Hz
- Made of steel
- Thickness
 - lower part: 1.8 mm / upper part 1.5 mm
- 2 solid wheels and 1 handlebar
- Spare band included
- Includes Power cable 18 AWG x 1.8 m
- Plastic motor cover

Workload:
15 min of work x
10 min of rest
Maximum daily: 4 hrs

STORAGE	
TC5065	1/2 SAC
TC5416	3/4 SAC



WARRANTY
2 YEARS



NOM

Code	Opening diameter	Drum capacity	Power	Speed	Inner	Master
TC5065	14 3/8"	120 L / 4.3 ft³ (1/2 BAG)	550W	40 rotations x min	1	1
TC5416	16 1/3"	180 L / 6.4 ft³ (3/4 BAG)	650W	32 rotations x min	1	1
Repuesto						
TC5065B		Band for cement mixer motor			1	50

Packaging: Box (TC5065, TC5416), Bulk (TC5065B)

CEMENT MIXER GAS-ENGINE 2.5 HP 1/2 BAG CAPACITY

- Engine capacity: 2.5 HP (97 cc)
- Made of steel
- Thickness: 1.8 mm
- With 2 pneumatic wheels of 10" and 1 handlebar
- Spare band included
- Capacity of the fuel tank 1.4 L (3 hours of use)
- Metal motor cover
- Total weight: 73 Kg

Workload:
1 tank x
60 min of rest



WARRANTY
2 YEARS

Delivered in 2 boxes



4-stroke engine; gasoline and oil are supplied in separate tanks

Warranty is subject to prior CSA assessment.

Code	Opening diameter	Drum capacity	Power	Speed	Inner	Master
TC5495	5 1/2"	160 L / 5.7 ft³ (1/2 SACO)	2.5 HP	30 rotations x min	1	1

Packaging: Box

ELECTRICAL WINCH

- Aluminum body
- Automatic break
- Remote control included
- Ideal to install in jeeps, trucks, ATVs and towing equipment

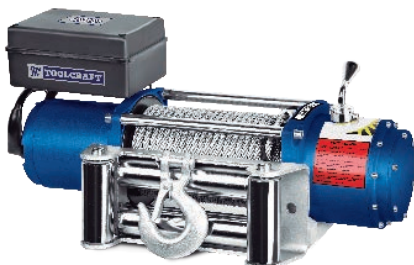

Includes remote control with a 3m reach



Includes remote control with a 1.5m reach

WARRANTY
2 YEARS

12 000 LB / 5,448 Kg

8 000 LB / 3,632 Kg

2 000 LB / 906 Kg

Code	TC4395	TC4394	TC5260
Power:		12 VCD	
Engine power:	5.5 HP (4,101 W)	3.6 HP (2,684 W)	3/4 HP (560 W)
Cable diameter:	3/8"	5/16"	5/32"
Cable length:		29 m	6.25 Kg
Weight:	40 Kg	38 Kg	99 cm
Workload:	1 min of work x 5 min of rest. Maximum daily: 6 hrs		
Inner:		1	
Master:	1		2

Packaging: Box

NAIL GUN NAIL IN ROLL

- Aluminum case
- Grip for better handle
- Air inlet connection: 1/4" NPT
- Use nails with a diameter of 2.5mm
- Deposit capacity: 225-300 nails
- Nail range (length): 1 3/4" to 2 3/4"
- Compatible with rolls of 225-300 nails
- Includes oil can and allen key.
- Weight: 3.9 kg

Work cycle:
continuous
(lubricate constantly)



Code	Nominal consumption	Work Pressure	Inner	Master
TC5357	3.2 CFM @ 90 psi	75-100 psi	1	4

Type of packaging: Case

NAIL GUN

- Aluminum case
- Grip for better handle
- Air inlet connection: 1/4" NPT
- Uses 18 gauge nails (1.24mm)
- Deposit capacity: 100 nails
- Nail range (length): 5/8" to 2"
- Adjustable deflector to address air vent
- Includes oil can and allen key.
- Weight: 1.4 kg

Work cycle:
continuous
(lubricate constantly)



Code	Nominal consumption	Work Pressure	Inner	Master
TC5356	2.1 CFM @ 90 psi	75-100 psi	1	10

Type of packaging: Case

AIR STAPLER

- Aluminum case
- Grip for better handle
- Air inlet connection: 1/4" NPT
- Uses 18-gauge staples (1.24 mm)
- Deposit capacity: 100 staples
- Staple range (length): 1/2" to 1 1/2", crown of: 1/4"
- Adjustable deflector to address air vent
- Includes oil can and allen key
- Weight: 1.3 kg

Work cycle:
continuous
(lubricate constantly)



Code	Nominal consumption	Work Pressure	Inner	Master
TC5355	2.1 CFM @ 90 psi	60-100 psi	1	10

Type of packaging: Case

NAILS IN ROLL FOR NAIL GUN

- Made of high carbon steel Q235
- Body with special rolling
- Great resistance to extraction
- 300 nails per roll
- Diameter of nail: 2.5 mm

Compatible with our
TC5357 pneumatic
nailer



Box
30 rolls
*Price per box

Code	Size	Gauge	Head Diameter	Inner	Master
TC5326	1 3/4"	12	6mm	1	1
TC5327	2"	12	6mm	1	1
TC5328	2 1/2"	12	6mm	1	1

Type of packaging: Box

NAILS FOR PNEUMATIC NAILER

- Made of steel with galvanized finish
- Nail with head
- 18 Gauge
- Compatible with the TC5356 pneumatic nailer
- Thickness 1.24 mm



Box
5,000 nails
*Price per box

Code	Size	Weight x box (5,000 pcs)	Inner	Master
TC5387	5/8"	0.61 kg	1	20
TC5388	3/4"	0.82 kg	1	20
TC5389	1"	1.04 kg	1	20
TC5390	1 1/4"	1.5 kg	1	20
TC5391	1 5/8"	1.7 kg	1	10
TC5392	2"	2.01 kg	1	10

Type of packaging: Box

STAPLES FOR PNEUMATIC STAPLER

- Made of steel with galvanized finish
- Made of 1/4" crown
- 18 Gauge
- 80 staples per strip
- Compatible with the TC5355 pneumatic stapler
- Thickness 1.24 mm



Box
5,000 staples
*Price per box

Code	Length	Inner	Master
TC5393	5/8"	1	16
TC5394	3/4"	1	12
TC5395	7/8"	1	12
TC5396	1"	1	10
TC5397	1 1/8"	1	10
TC5398	1 1/4"	1	8

Type of packaging: Box

1/2" PROFESSIONAL IMPACT WRENCH

- Polished aluminum case
- Twin Hammer mechanism
- Air inlet connection: 1/4" NPT
- Frame 1/2"
- Variable speed (7,000 rpm)
- Weight: 2.5 kg

Workload:
continuous (lubricate constantly)



Code	Nominal consumption	Torque Range	Inner	Master
TC5349	3.9 CFM @ 90 psi	50-450 lb/ft	1	8

Type of packaging: Box

1/2" IMPACT WRENCH

- Polished aluminum case
- Rocking dog mechanism
- Air inlet connection: 1/4" NPT
- Frame 1/2"
- Variable speed (7,000 rpm)
- Weight: 2.1 kg

Workload:
continuous (lubricate constantly)



Code	Nominal consumption	Torque Range	Inner	Master
TC5348	3.6 CFM @ 90 psi	30-260 lb/ft	1	8

Type of packaging: Box

1/2" IMPACT WRENCH KIT

- Includes TC5348 impact wrench
- Polished aluminum case
- Rocking dog mechanism
- Air inlet connection: 1/4" NPT
- Frame 1/2"
- Variable speed (7,000 rpm)
- Weight: 2.1 kg

Accessories:

- 10 Sockets:
 - 3/8", 7/19", 1/2", 9/16", 5/8", 11/16", 3/4", 16", 7/8", 15/16"
- Extension of 5"
- Air filter
- Oil canister
- 4mm allen key
- Nipple 1/4" NPT

Work cycle: continuous
(lubricate constantly)



Code	Nominal consumption	Torque Range	Inner	Master
TC5350	3.6 CFM @ 90 psi	30-260 lb/ft	1	4

Type of packaging: Case

PNEUMATIC TOOL | RATCHET | GUNS

RATCHET 1/2"

- Aluminum case
- Air inlet connection: 1/4" NPT
- Frame 1/2"
- Speed 160 rpm
- Reversible
- Weight: 1.2 kg



Workload:
continuous (lubricate constantly)



Code	Nominal consumption	Torque Range	Inner	Master
TC5353	3.1 CFM @ 90 psi	5-50 lb/ft	1	20

Type of packaging: Box

1/4" ANGLE GRINDER

- Aluminum case
- Air inlet connection: 1/4" NPT
- Clamp 1/4"
- Variable speed
- Key included
- Weight: 0.3 kg



Workload:
continuous (lubricate constantly)



Code	Speed	Nominal consumption	Inner	Master
TC5351	25,000 rpm	2.9 CFM @ 90 psi	2	20

Type of packaging: Box

1/4" MINI ANGLE GRINDER KIT

- Includes mini TC5351 grinder
- Aluminum case
- Air inlet connection: 1/4" NPT
- Clamp 1/4"
- Variable speed
- Key included
- Weight: 0.3 kg



Accessories:

- 1 collect 1/4 " and 1 collect 1/8 "
- Stones mounted: 5 pieces of 1/4 " and 5 pieces of 1/8 "
- Nipple 1/4 " NPT
- 7/16 " and 11/16 " key



Work cycle: continuous (lubricate constantly)

Code	Speed	Nominal consumption	Inner	Master
TC5352	25,000 rpm	2.9 CFM @ 90 psi	2	10

Type of packaging: Case

FINISHING SANDER 6"

- Aluminum case
- Air inlet connection: 1/4" NPT
- Vinyl Pad 6"
- Variable speed
- Weight: 0.83 kg



Workload:
continuous (lubricate constantly)



Code	Speed	Nominal consumption	Inner	Master
TC5354	11,000 rpm	2.7 CFM @ 90 psi	1	10

Type of packaging: Box

MACHINE CLEANING GUN

- Aluminum body and brass nozzle
- 1 m plastic hose
- Long wand
- Removes grease and grime
- Air intake connection: 1/4 "NTP



Code	Maximum Pressure	Inner	Master
TC4290	90 PSI	4	24

Type of packaging: Box

ENGINE CLEANING GUN

- Made in cast aluminum alloy
- 0.9-liter glass
- 3 mm nozzle
- To remove grease and grime
- For spraying oils, cleaners and antioxidants
- Air intake connection: 1/4 "NTP



Code	Air consumption	Pressure	Inner	Master
TC4175	6 -11 CFM	60 - 100 PSI	1	10

Type of packaging: Box

AIR BLOW GUN, METAL

- Made of aluminum
- 5" short nozzle
- Air intake connection: 1/4 "NTP



Code	Maximum Pressure	Inner	Master
TC2034	120 PSI	6	36

Type of packaging: Blister

COMPACT AIR BLOW GUN, METAL

- Made of aluminum
- 4" short nozzle
- Air intake connection: 1/4 "NTP

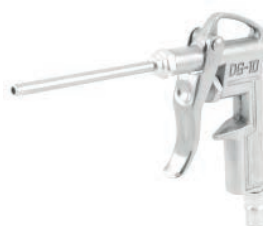

Code	Maximum Pressure	Inner	Master
TC2033	120 PSI	6	36

Type of packaging: Blister

AIR BLOW GUN

- Resistant POM body
- 6" long nozzle
- Air intake connection: 1/4 "NTP



Code	Maximum pressure	Inner	Master
TC2032	90 PSI	6	36

Type of packaging: Blister

HIGH PRESSURE AIR HOSE

- Rubber hose
- Brass end fittings (male and male)



Code	Hose	Length	Connection	Maximum Pressure	Inner	Master
TC5133	1/4"	10 m	1/4" NPT	300 PSI	2	12
TC5134	1/4"	15 m	1/4" NPT	300 PSI	2	12
TC5132	3/8"	7.5 m	1/4" NPT	300 PSI	2	6
TC2024	3/8"	10 m	1/4" NPT	300 PSI	2	6
TC2025	3/8"	15 m	1/4" NPT	300 PSI	2	6
TC5135	1/2"	10 m	3/8" NPT	900 PSI	1	6
TC5136	1/2"	15 m	3/8" NPT	900 PSI	1	6

Type of packaging: Cardboard

LOW PRESSURE HYBRID AIR HOSE

- PVC and rubber hose
- Brass end fittings (female and male)
- 300 PSI maximum pressure capacity
- 300 PSI maximum pressure capacity
- Connection 1/4"



Code	Hose	Length	Connection	Inner	Master
TC5105	3/8"	7.5 m	1/4" NPT	2	10
TC5106	3/8"	10 m	1/4" NPT	2	8

Type of packaging: Cardboard

LOW PRESSURE AIR HOSE

- PVC hose
- Brass end fittings (female and male)
- 300 PSI maximum pressure capacity
- 300 PSI maximum pressure capacity
- Connection 1/4"



Code	Hose	Length	Connection	Inner	Master
TC3044	1/4"	5 m	1/4" NPT	3	9
TC3045	1/4"	10 m	1/4" NPT	3	9
TC5104	1/4"	15 m	1/4" NPT	3	8

Type of packaging: Cardboard

1/4" BRASS COUPLER

- Ideal for air tank and compressors
- NPT thread



Code	Connector	Inner	Master
TC2010	Female / Female	12	96

Type of packaging: Blister

BRASS AIR CHUCK

- Ideal for air tank and compressors
- 1/4" NPT connection



Code	Connector	Inner	Master
TC2011	Female	12	144

Type of packaging: Blister

1/4" BRASS NIPPLE

- Ideal for air tank and compressors
- NPT thread



Code	Connector	Inner	Master
TC2009	Male / Male	12	96

Type of packaging: Blister

1/4" BRASS QUICK COUPLER

- NPT thread



Code	Connector	Inner	Master
TC2001	Female	12	144
TC2002	Male	12	144

Type of packaging: Blister

1/4" BRASS QUICK CONNECTOR

- NPT thread



Code	Connector	Inner	Master
TC2003	Female	12	144
TC2004	Male	12	144

Type of packaging: Blister

SPRING TYPE AIR HOSE

- PVC hose
- Brass end fittings
- 200 PSI maximum pressure capacity



Code	Connection	Length	Inner	Master
TC2026	1/4"	7.5 m	6	12
TC2027	1/4"	15 m	6	12

Type of packaging: Bulk

"F" TYPE BRASS QUICK COUPLER

- Ideal for air tank and compressors



Code	Connection	Inner	Master
TC4291	1/4" NPT	5	144

Type of packaging: Blister

1/4" DUAL BRASS AIR CHUCK

- Large head for easy assembly in truck tires



Code	Connection	Inner	Master
TC4292	1/4" NPT	6	48

Type of packaging: Blister

MANOMETER

- Ideal for air tank and compressors



Code	Pressure	Inner	Master
TC2030	0 - 100 PSI	10	100
TC2031	0 - 200 PSI	10	100

Type of packaging: Box

PNEUMATIC TOOL | ACCESSORIES

14-PIECE PNEUMATIC ACCESSORY SET

- Made in brass and steel
- Maximum pressure: 90 PSI
- Content:
 - 1 PVC air hose, 7.62m (25ft)
 - 1 brass coupler for 1/4" thread hose
 - 1 nipple for hose with 1/4" thread
 - 2 female quick brass coupler with 1/4" thread
 - 2 male quick connectors with 1/4" thread
 - 2 female quick connectors with 1/4" thread
 - 1 metal inflating needle
 - 1 metal air blow gun
 - 1 plastic nozzle for blow gun
 - 1 brass inflating head
 - 1 adapter for needle and gun connection



Code	Connection	Inner	Master
TC2029	1/4" NPT	2	12

Type of packaging: Blister

17-PIECE PNEUMATIC ACCESSORY SET

- Made in brass and steel
- Maximum pressure: 90 PSI
- Content:
 - 1 metal air blow gun
 - 1 metal pressure gauge
 - 1 tire double inflating valve
 - 1 metal inflating needle
 - 1 inflating nozzle adapter
 - 1 safety nozzle for air blow gun
 - 4 brass male connectors 1/4" thread
 - 1 brass nozzle to inflate with blowtorch
 - 1 brass connector for hose with 1/4" thread
 - 2 brass female connectors 1/2" NPT 2 pcs
 - 2 connectors for brass hose double thread 1/4"
 - 1 quick-change coupling female brass 1/4" with 1/2" thread



Code	Connection	Inner	Master
TC2028	1/4" NPT	2	24

Type of packaging: Blister

METAL AIR BLOW GUN

- Made of steel alloy
- Chrome finish
- PVC covered lever
- Nozzle for directed air flow
- 2 interchangeable nozzles included
- For cleaning duties
- Air intake connection: 1/4" NTP



Code	Maximum Pressure	Inner	Master
TC2014	90 PSI	6	36

Type of packaging: Blister

6-PIECE AIR BLOW GUN KIT

- 1 sprinkler extension
- 1 brass valve adapter
- 1 high pressure nozzle
- 1 plastic covered conic nozzle
- 1 ball inflating valve
- 1 needle tip inflator
- Air intake connection: 1/4" NTP



Code	Maximum Pressure	Inner	Master
TC4293	90 PSI	6	48

Type of packaging: Blister

5-NOZZLE AIR BLOW GUN KIT

- 3 nozzles with extension
- 1 conical nozzle
- 1 nozzle without extension
- Air intake connection: 1/4" NTP



Code	Maximum Pressure	Inner	Master
TC4289	90 PSI	6	48

Type of packaging: Blister

AIR REGULATOR

- 3 measurement scales: kg / cm², PSI, kPa



Code	Maximum Pressure	Connection	Inner	Master
TC4294	160 PSI	1/4" NPT	6	24

Type of packaging: Box

OIL/WATER FILTER SEPARATOR

- Aluminum base and polycarbonate body
- Prevents pneumatic tool rusting



Code	Maximum Pressure	Connection	Inner	Master
TC4295	120 PSI	1/4" NPT	6	24

Type of packaging: Blister

AIR VOLUME CONTROL

- For hydro-pneumatic equipment tanks



Code	Capacity	Inner	Master
TC2744	100 gallons	2	25

Type of packaging: Box

5-PIECE BRASS QUICK COUPLER AND CONNECTOR KIT

- Maximum pressure: 90 PSI
- Content:
 - 1 female quick coupler
 - 3 male quick connectors
 - 1 female quick connector



Code	Connection	Inner	Master
TC2005	1/4" NPT	12	72

Type of packaging: Blister

6-PIECE HOSE ACCESSORY SET

- Made of solid brass and steel
- Content:
 - 1 metal inflating head, 1/4 NPT
 - 1 brass quick double barb connector for 3/8"
 - 1 brass quick double connector for 3/8" hose with 1/4 NPT thread
 - 3 5/8" stainless steel hose clamps



Code	Characteristics	Inner	Master
TC2008	6-pieces set	4	72

Type of packaging: Blister

1/4" STEEL QUICK COUPLER

- Chrome finish
- NPT thread



Code	Connector	Inner	Master
WF0146	Female	6	144
WF0147	Male	6	144

Type of packaging: Blister

1/4" STEEL QUICK COUPLER

- Chrome finish
- NPT thread

thread



Code	Connector	Inner	Master
WF0151	Female	6	144
WF0152	Male	6	144

Type of packaging: Blister

INFLATING VALVE

- Made of chromed steel



Recommended for inflating balls, inflatable mattress etc.

Code	Connector	Inner	Master
WF8201	1/4"	100	5000

Type of packaging: Bulk

1/4" DUAL AIR CHUCK

- Metal body
- Chrome finish



Code	Connection	Inner	Master
WF0150	1/4" NPT	6	6

Type of packaging: Bag

14-PIECE PNEUMATIC ACCESSORY SET

- Made of steel and zinc
- Maximum pressure 90 PSI
- Input 1/4" NPT
- Content:
 - 1 PVC air hose, 7.62 m (25ft)
 - 1 coupler for 1/4" thread hose
 - 1 nipple for hose with 1/4" thread
 - 2 female quick couplers with 1/4" thread
 - 2 male quick connectors with 1/4" thread
 - 2 female quick connectors with 1/4" thread
 - 1 metal inflating needle
 - 1 metal air blow gun
 - 1 plastic nozzle for blow gun
 - 1 inflating head
 - 1 adapter for needle and gun connection



Code	Connection	Inner	Master
WF0148	1/4" NPT	2	12

Type of packaging: Blister

17-PIECE PNEUMATIC ACCESSORY SET

- Made of steel and zinc
- Maximum pressure 90 PSI
- Content:
 - 1 metal air blow gun
 - 1 metal pressure gauge
 - 1 tire double inflating valve
 - 1 metal inflating needle
 - 1 inflating nozzle adapter
 - 1 safety nozzle for air blow gun
 - 4 male connectors with 1/4" thread
 - 1 nozzle for air blown gun
 - 1 connector for 1/4" thread hose
 - 2 female connectors with 1/2" thread NPT, 2 pieces
 - 2 double connectors for 1/4" thread hose
 - 1 1/4" female quick coupler with 1/2" thread



Code	Connection	Inner	Master
WF0149	1/4" NPT	2	24

Type of packaging: Blister

5-PIECE STEEL QUICK COUPLER AND CONNECTOR KIT

- Chrome finish
- Maximum pressure: 90 PSI
- Content:
 - 1 female quick coupler
 - 3 male quick connectors
 - 1 female quick connector



Code	Connection	Inner	Master
WF0153	1/4" NPT	6	72

Type of packaging: Blister

NYLON THREAD FOR BRUSHCUTTER

- Impact resistant
- Available in roll and blister packaging
- Can be used on electric brush cutters and gas-engine to cut grass plants and lawn



Cross-head type wire

Code	Color	Diameter Roll	Length	Inner	Master
TC3212	Green	2 mm	120 m	4	32
TC3213	Orange	2.4 mm	78 m	4	32
TC3214	Red	2.7 mm	63 m	4	32
TC3215	Yellow	3.3 mm	48 m	4	32
Blister					
TC3216	Blue	1.65 mm	15 m	12	72
TC3217	Green	2 mm	15 m	12	72
TC3218	Orange	2.4 mm	12 m	12	72
TC3219	Red	2.7 mm	12 m	12	72

Type of packaging: Blister and Roll



GARDENING



METAL - PLASTIC LAWN RAKE 22 TINES

- Tempered metal tines offering flexibility and avoiding deformation
- Metal tensor for higher resistance
- 47" fine and treated wood handle included
- Spare handle: TC1472



Code	Characteristics	Inner	Master
TC0660	Flexible teeth	3	4

Type of packaging: Bulk

METAL LAWN RAKE WITH TENSOR 22 TINES

- Tempered metal tines offering flexibility and avoiding deformation
- Metal tensor for higher resistance included
- 47" fine and treated wood handle included
- Spare handle: TC1472



Code	Characteristics	Inner	Master
TC0662	Flexible teeth	5	4

Type of packaging: Bulk

REINFORCED METAL LAWN RAKE 22 TINES

- Tempered metal tines offering flexibility and avoiding deformation
- 47" fine and treated wood handle included
- Spare handle: TC1472



Code	Characteristics	Inner	Master
TC0663	Flexible teeth	3	10

Type of packaging: Bulk

METAL LAWN RAKE 20 TINES

- Tempered metal tines offering flexibility and avoiding deformation
- 47" fine and treated wood handle included
- Spare handle: TC1472



Code	Characteristics	Inner	Master
TC0664	Flexible teeth	10	10

Type of packaging: Bulk

PLASTIC LAWN RAKE 30 TINES

- 47" fine and treated wood handle included
- Spare handle: TC1472



Code	Characteristics	Inner	Master
TC4033	Flexible teeth	3	3

Type of packaging: Bulk

PLASTIC LAWN RAKE 26 TINES

- 47" fine and treated wood handle included
- Spare handle: TC1472



Code	Characteristics	Inner	Master
TC3515	Flexible teeth	5	4

Type of packaging: Bulk

METAL LAWN RAKE FOLDING 15 TINES

- Made with hardened steel strap
- Tubular PVC handle
- Fits large and small spaces



Wolfcraft

Code	Characteristics	Inner	Master
WF2980	Fan type	6	24

Type of packaging: Bulk

METAL LAWN RAKE 20 TINES

- Tempered metal tines offering flexibility and avoiding deformation
- 47" fine and treated wood handle included
- Spare handle: TC1472.



Wolfcraft

Code	Characteristics	Inner	Master
WF9727	Flexible teeth	12	48

Type of packaging: Bulk

WOOD HANDLE FOR LAWN RAKE

- Varnished



For rake

Code	Size	Inner	Master
TC1472	47"	6	60

Type of packaging: Bulk

15 L BACKPACK SPRAYER

- For agricultural and gardening uses
- Central piston pump system
- Brass pipette
- Adjustable brass nozzle
- High density polyethylene tank
- 1,5 m PVC hose
- Wide mouth opening for easy filling
- Padded belt

Agricultural use
* Does not generate VAT



SPECIFICATIONS

D / hose	1 cm
Length / pipette	36 cm



Code	Capacity	Pressure	Weight	Inner	Master
TC4165	15 L (3,9 gal)	29 - 72 PSI	3,5 kg	1	1

Type of packaging: Box

12 L BACKPACK SPRAYER

- For agricultural and gardening uses
- Lateral piston pump system
- Fiberglass pipette
- Adjustable fiberglass nozzle
- High density polyethylene tank
- 1,5 m PVC hose
- Wide mouth opening for easy filling
- Padded belt

Agricultural use
* Does not generate VAT



SPECIFICATIONS

D / hose	1,1 cm
Length / pipette	61 cm



Code	Capacity	Pressure	Weight	Inner	Master
TC4166	12 L (3,1 gal)	29 - 72 PSI	3,5 kg	1	1

Type of packaging: Box

LAWN SPRAYER

- Agricultural use and gardening
- Central piston pump system
- Brass pipette and nozzle
- Polyethylene tank
- 1,5 m PVC hose
- Wide mouth for easy filling

Agricultural use
* Does not generate VAT



SPECIFICATIONS

D / hose	1 cm
Length / pipette	36 cm



Code	Capacity	Pressure	Inner	Master
TC4167	11 L (3 gal)	29 - 72 PSI	1	6
TC2865	7,6 L (2 gal)	29 - 72 PSI	1	6
TC2864	3,8 L (1 gal)	29 - 72 PSI	1	6 T

Type of packaging: Box

2L HOUSEHOLD SPRAYER

- Cleaning Agricultural use and gardening
- Adjustable brass nozzle
- Pressure 36 PSI

Agricultural use
* Does not generate VAT



Code	Capacity	Inner	Master
TC4169	2 L (0,5 gal)	4	16

Type of packaging: Box

SPRAY BOTTLE

- Polyethylene atomizer
- Anti-leakage trigger



Code	Capacity	Inner	Master
TC3562	0,5 L	12	24
TC3563	1 L	12	24

Type of packaging: Bag

16 L BACKPACK SPRAYER

- For agricultural and gardening use
- Lateral piston pump system
- Fiberglass pipette
- Polypropylene nozzle
- Polyethylene tank
- PVC hose: 1,6 m
- Wide mouth for easy filling

Wolfox



Agricultural use
* Does not generate VAT

SPECIFICATIONS

D / hose	1 cm
Length / pipette	58 cm

Code	Capacity	Pressure	Weight	Inner	Master
WF0011	16 L (4,2 gal)	44 PSI	2,3 kg	1	1

Type of packaging: Box

5L LAWN SPRAYER

- For agricultural and gardening use
- Side piston pump system
- Brass pipette: 35 cm
- Brass nozzle
- Polyethylene tank
- PVC hose: 1.1 m
- Wide mouth for easy filling

Wolfox



SPECIFICATIONS

Pressure	36 PSI
D / hose	0,8 cm
Length / pipette	35 cm
Weight	1 kg



Agricultural use
* Does not generate VAT

Code	Capacity	Inner	Master
WF0012	5 L (1,3 gal)	1	10

Type of packaging: Box

1.2L HOUSEHOLD SPRAYER

- Cleaning Agricultural use and gardening
- Adjustable brass nozzle
- Pressure 36 PSI

Wolfox



Agricultural use
* Does not generate VAT

Code	Capacity	Inner	Master
WF0013	1,2 L (0,3 gal)	4	12

Type of packaging: Box

RUBBER GASKET SET

- Pressure relief valve
- Wand gasket set
- Hose gasket set
- Dispenser handle gasket set
- Compatible with fumigators:
TC4165, TC4166, TC2864, TC2865
TC4167, WF0011 y WF0012.

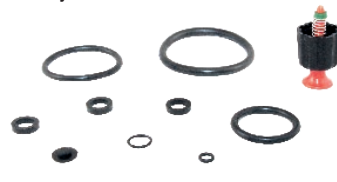

Code	Content	Inner	Master
TC3187	10 pieces	1	10

Type of packaging: Bag

HANDLE REPLACEMENT DISPENSER WITH ROD

- Flexible hose
- Dosing handle
- Brass nozzle
- Brass lancet
- Compatible with models:
TC4165, TC4166,
TC2864, TC2865,
TC4167, WF0011,
WF0012



Code	Characteristics	Inner	Master
TC3186	1 set of 4 pieces	4	40

Type of packaging: Easel

GARDENING | HOSES

5/8" GARDEN HOSE, 3-PLY, BRASS CONNECTOR

- Reinforced and resistant 3-ply hose
- Gaskets included
- Maximum pressure: PSI



Code	Measure / Length	Wall thickness	Inner	Master
TC5121	5/8" x 15 m	2.1 mm	1	5
TC5122	5/8" x 20 m	2.1 mm	1	4
TC5123	5/8" x 25 m	2.1 mm	1	3

Type of packaging: Roll

1/2" GARDEN HOSE, 3-PLY, BRASS CONNECTOR

- Reinforced and resistant 3-ply hose
- Gaskets included
- Maximum pressure: PSI



Code	Measure / Length	Wall thickness	Inner	Master
TC5125	1/2" x 10 m	1.8 mm	1	7
TC5126	1/2" x 15 m	1.8 mm	1	6
TC5127	1/2" x 20 m	1.8 mm	1	5
TC5128	1/2" x 25 m	1.8 mm	1	4

Type of packaging: Roll

*Price per roll

1/2" REINFORCED HOSE, 3-PLY, 100 M ROLL

- Reinforced and resistant 3-ply hose
- Connectors not included
- Maximum pressure: 300 PSI



*Price per roll

Code	Size	Length	Wall thickness	Inner	Master
TC5129	1/2"	100 m	1.8 mm	1	2
TC5130	5/8"	100 m	2.1 mm	1	2
TC5131	3/4"	100 m	2.5 mm	1	1

Type of packaging: Roll

1/2" REINFORCED HOSE, 2-PLY, 100 M ROLL

- Connectors not included
- Maximum pressure: 260 PSI

Wolfox



*Price per roll

Code	Size	Length	Wall thickness	Inner	Master
WF0616	1/2"	100 m	1.5 mm	1	2

Type of packaging: Roll

1/2" REINFORCED HOSE, 2-PLY, PLASTIC CONNECTOR

- Gaskets included
- Maximum pressure: 260 PSI

Wolfox



*Price per roll

Code	Size	Length	Wall thickness	Inner	Master
WF9884	1/2"	10 m	1.5 mm	1	8
WF9885	1/2"	15 m	1.5 mm	1	6

Type of packaging: Roll

EXPANDABLE HOSE

- Includes 7 functions gun
- Made of latex, light and resistant
- Continuous flow
- Brass connector (3/4 ")
- Includes brass through valve

Wolfox
IMPROVED PRODUCT



- * Avoid long-lasting sun exposure
- * Do not place heavy objects on the hose

Code	Length	Max. pressure	Inner	Master
WF0784	15 m	10 kg	1	6
WF0785	22.5 m	10 kg	1	6

Type of packaging: Box

INDUSTRIAL HOSE, 100 M ROLL

- Clear PVC body
- To transport any non-corrosive liquid that is not under pressure



*Price per roll

Code	Size	Length	Wall thickness	Inner	Master
TC2304	1/2"	100 m	0.90 mm	1	1

Type of packaging: Roll

WATER LEVEL HOSE, 100 M ROLL

- Clear PVC body
- To transport any non-corrosive liquid that is not under pressure



*Price per roll

Code	Size	Length	Wall thickness	Inner	Master
TC2305	1/4"	100 m	0.66 mm	1	1
TC2306	5/16"	100 m	0.66 mm	1	1
TC2307	3/8"	100 m	0.66 mm	1	1

Type of packaging: Roll

BALL VALVE OUTDOOR FAUCET

- Made of brass
- Inlet 1/2", 6 threads
- Outlet: 3/4", 3 threads
- Weight: 145 g



More outdoor faucets in section **YARDEN**. Page 228

Code	Size	Inner	Master
TC0864	1/2"	12	120

Type of packaging: Card

BALL VALVE OUTDOOR FAUCET

- Zinc body
- Inlet: 1/2"
- Outlet: 3/4"



More outdoor faucets in section **YARDEN**. Page 228

Code	Size	Inner	Master
*WF9646	1/2"	24	120

Type of packaging: Bulk

METAL BASE REVOLVING SPRINKLER

- Watering area: 360°
- Aluminum arms
- Inlet 3/4"



Code	Pressure	Inner	Master
TC3237	40 to 50 PSI	6	24

Type of packaging: Box

PLASTIC REVOLVING SPRINKLER

- Watering area: 360°
- Aluminum arms
- Inlet 3/4"



Code	Pressure	Inner	Master
WF1684	40 to 50 PSI	12	72

Type of packaging: Bag



METAL PULSATING SPRINKLER

- Watering area: 90°, 180°, 270°, 360°
- Inlet 3/4"



Code	Ways	Pressure	Inner	Master
TC0858	2	40 to 50 PSI	6	48
TC1875	1	40 to 50 PSI	4	48

Type of packaging: Card

METAL PULSATING SPRINKLER

- Watering area: 90°, 180°, 270°, 360°



Code	Pressure	Inner	Master
TC1877	40 to 50 PSI	6	48

Type of packaging: Card

PLASTIC PULSATING SPRINKLER, METAL SPIKE

- Watering area: 90°, 180°, 270°, 360°
- Inlet 3/4"



Code	Ways	Pressure	Inner	Master
TC0859	2	40 to 50 PSI	6	48
TC1876	1	40 to 50 PSI	6	48

Type of packaging: Card

WATERING WAND

- Metal body
- PVC handle
- Reinforced nylon lever
- Clip for continuous spraying
- Breaker head
- 71 cm long



PLASTIC REVOLVING SPRINKLER 2 WAYS, PLASTIC SPIKE

- Watering area: 90°, 180°, 270°, 360°
- Inlet 3/4"



Code	Pressure	Inner	Master
WF0602	40 to 50 PSI	12	48

Type of packaging: Card

PLASTIC REVOLVING SPRINKLER

- Watering area: 90°, 180°, 270°, 360°



Code	Pressure	Inner	Master
TC1878	40 to 50 PSI	6	48

Type of packaging: Card

Code	Model	Inner	Master
TC1857	1 function	4	24

Type of packaging: Bulk

GARDENING | WATERING

PVC-METAL HOSE NOZZLE, 9 FUNCTIONS

- Reinforced nylon lever
- PVC covered handle
- Clip for continuous spraying



Code	Model	Inner	Master
TC1847	9 functions	6	48

Type of packaging: Card

PVC-METAL HOSE NOZZLE, 7 FUNCTIONS

- Reinforced nylon lever
- PVC covered handle
- Clip for continuous spraying



Code	Model	Inner	Master
TC1846	7 functions	6	48

Type of packaging: Card

ADJUSTABLE PVC-PLASTIC HOSE NOZZLE

- Reinforced nylon lever
- PVC covered handle
- Clip for continuous spraying



Code	Model	Inner	Master
TC1848	1 function	6	48

Type of packaging: Card

PVC-METAL HOSE NOZZLE

- PVC covered handle
- Reinforced nylon lever
- Clip for continuous spraying



Code	Model	Inner	Master
TC1849	1 function	6	48

Type of packaging: Card

TRADITIONAL METAL HOSE NOZZLE

- Reinforced nylon lever
- Clip for continuous spraying



Code	Model	Inner	Master
TC0740	Traditional	12	48

Type of packaging: Card

PVC-PLASTIC HOSE NOZZLE 7 FUNCTIONS

- Reinforced nylon lever
- Clip for continuous spraying
- Handle covered with PVC



Code	Model	Inner	Master
TC1852	7 functions	12	48

Type of packaging: Card

ADJUSTABLE PVC-PLASTIC HOSE NOZZLE

- PVC covered handle
- Reinforced nylon lever
- Clip for continuous spraying



Code	Model	Inner	Master
TC1851	Adjustable	12	48

Type of packaging: Card

PLASTIC HOSE NOZZLE 6 FUNCTIONS

- Clip for continuous spraying
- Adjustable flow



Code	Model	Inner	Master
WF0309	6 functions	12	48

Type of packaging: Card

PLASTIC HOSE NOZZLE 5 FUNCTIONS

- Clip for continuous spraying
- Adjustable flow



Code	Model	Inner	Master
WF0308	5 functions	12	48

Type of packaging: Card

Wolfax

PLASTIC HOSE NOZZLE

- Clip for continuous spraying
- Adjustable flow



Code	Size	Inner	Master
WF0311	4 1/2"	12	48
WF0305	5 1/2"	24	144

Type of packaging: Card

Wolfax

BRASS HOSE NOZZLE

- 3/4" NTP thread
- Adjustable nozzle for pressure control



Code	Length	Inner	Master
TC0897	3"	10	200

Type of packaging: Bag

PLASTIC HOSE NOZZLE

- 3/4" NPT thread
- Adjustable nozzle for pressure control



Code	Length	Inner	Master
WF0310	4"	20	200

Type of packaging: Card

BRASS HOSE CONNECTORS SET

- Male and female 3/4" NPT thread



Code	Inlet	Inner	Master
TC3486	1/2"	10	300
TC0861	1/2"	10	500
TC0863	5/8"	10	300
TC0862	3/4"	1	200

Type of packaging: Blister (TC3486) / bulk (TC0861, TC0863, TC0862)

FEMALE BRASS CONNECTOR

- 3/4" NPT thread



Code	Inlet	Inner	Master
TC3485	1/2"	10	600
TC0860	1/2"	10	600
TC0893	5/8"	10	600
TC0892	3/4"	10	400

Type of packaging: Blister (TC3485) / Bulk (TC0860, TC0893, TC0892)

METAL "Y" ADAPTER

- Converts a simple water outlet into double
- Spherical pitch controls for each outlet



Code	Input / Output	Inner	Master
TC1859	3/4"	6	48

Type of packaging: Card

PLASTIC HOSE REPAIR CONNECTOR

- High impact plastic
- For use on hoses of all types of rubber and plastic



Code	Inlet	Inner	Master
TC1856	1/2"	24	72

Type of packaging: Card

FEMALE PLASTIC HOSE CONNECTOR

- 3/4" NPT thread



Code	Inlet	Inner	Master
TC1855	1/2"	12	72

Type of packaging: Card

MALE PLASTIC HOSE CONNECTOR

- 3/4" NPT thread



Code	Inlet	Inner	Master
TC1854	1/2"	12	72

Type of packaging: Card

HOSE CONNECTORS SET

- 3/4" NPT thread
- Male and female



Code	Inlet	Inner	Master
WF9649	1/2"	20	500

Type of packaging: Bulk

FEMALE CONNECTOR

- 3/4" NPT thread



Code	Inlet	Inner	Master
WF9648	1/2"	40	600

Type of packaging: Bulk

ABS "Y" ADAPTER

- Converts a simple water outlet into double
- Spherical pitch controls for each outlet



Code	Input / Output	Inner	Master
WF0301	3/4"	10	100

Type of packaging: Card

RUBBER GASKET SET

- Made of PVC
- Each set includes 10 gaskets



*Price per template

Code	Size	Inner	Master
TC2062	1"	20	120

Type of packaging: Bulk

RUBBER GASKET SET

- Made of rubber
- Each template includes 12 gaskets



*Price per template

Code	Size	Inner	Master
WF0307	1"	10	100

Type of packaging: Bulk

TOOLS FOR AGRICULTURE

FORGED GARDEN HOE WITH HANDLE

- Made of stainless steel 1045
- Polished head in cutting area
- Head with sharpened edges
- Forges in one single piece
- Round eye
- 120 cm (47") handle



Code	Weight of Head	Width of blade	Inner	Master
TC0450	N-1, 1.6 lb	7 1/2"	3	6
TC0451	N-2, 1.7 lb	8"	3	6
TC0452	N-3, 1.8 lb	8 1/2"	4	6

Type of packaging: Bulk

FORGED GARDEN HOE WITH HANDLE

- Hoe**
- Made of stainless steel 1045
 - Polished head in cutting area
 - Head with sharpened edges
 - Forges in one single piece
 - Round eye

Wooden handle

- Natural finish



Code	Weight of Head	Width of blade	Inner	Master
TC1393	N-1, 1.6 lb	7 1/2"	4	24
TC1394	N-2, 1.7 lb	8"	3	24
TC1395	N-3, 1.8 lb	8 1/2"	3	24
Wooden handle for hoe				
TC1469	120 cm (47")		6	6

Type of packaging: Bulk

MANURE FORK

- Made of steel carbon steel
- Fork forged in one single piece
- Wood handle measuring 54" (130 cm)
- Pin fastening to the cone with epoxy resin

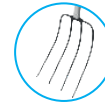

*Manure fork 4 teeth



*Manure fork 5 teeth



*Delivered with protectors on the tips to prevent accidents

Code	Characteristics	Head	Inner	Master
TC2043	4 teeth	8 1/2"	3	6
TC2044	5 teeth	9"	3	6
TC4218	6 teeth	10"	3	6

Type of packaging: Bulk

48" HERCULES PATTERN POST HOLE DIGGER FIBERGLASS HANDLE

- 2 pieces tempered steel blades
- Fiberglass handles
- 6 1/4" opening
- For agricultural use



Code	Size	Inner	Master
TC5284	48"	2	2

Type of packaging: Bulk

48" HERCULES PATTERN POST HOLE DIGGER

- 2 pieces tempered steel blades
- Handles of treated wood
- 6 1/4" opening
- For agricultural use



Code	Size	Inner	Master
TC2040	48"	2	6

Type of packaging: Bulk

45" ATLAS PATTERN POST HOLEDIGGER

- 1 piece tempered steel blades
- Treated wood handles
- Tempered steel blades
- Opening: 5 3/4"
- For gardening



Code	Size	Inner	Master
TC2039	45"	2	6

Type of packaging: Bulk

16-TOOTH BOW RAKE

- 60" treated wood handle
- Reinforced for construction and agricultural work



Code	Characteristics	Head width	Inner	Master
TC2042	1/4" steel	16"	4	6

Type of packaging: Bulk

14-TOOTH BOW RAKE

- 48" treated wood handle
- Arc model



Code	Characteristics	Head width	Inner	Master
TC2041	3/16" steel	16 1/2"	6	6

Type of packaging: Bulk

AXE, HALF LABOR

- Made of carbon steel
- Fully polished edge
- With protection for the edge
- Straight handle



Oval eye

Without handle:
TC0694
TC0695
TC0696

With handle:
TC0691
TC0692
TC0693

Code	Head weight	Handle	Inner	Master
TC0694	3 lb	Without handle	4	12
TC0695	3.5 lb	Without handle	4	12
TC0696	4 lb	Without handle	4	12
TC0691	3 lb	With handle	2	24
TC0692	3.5 lb	With handle	2	24
TC0693	4 lb	With handle	2	24

Type of packaging: Bulk

AXE, FULL LABOR

- Made of carbon steel
- Fully polished edge
- With protection for the edge
- Straight handle



Oval eye

Without handle:
TC0688
TC0689
TC0690

With handle:
TC0685
TC0686
TC0687

Code	Head weight	Handle	Inner	Master
TC0688	3 lb	Without handle	4	12
TC0689	3.5 lb	Without handle	4	12
TC0690	4 lb	Without handle	4	12
TC0685	3 lb	With handle	2	24
TC0686	3.5 lb	With handle	2	24
TC0687	4 lb	With handle	2	24

Type of packaging: Bulk

MICHIGAN AXE WITH 35" HANDLE

- Made of carbon steel
- Fully polished edge
- With protection for the edge
- Hinged curved handle



Oval eye

Code	Head weight	Inner	Master
TC0697	3.5 lb	2	12

Type of packaging: Bulk

HUNTER AXE WITH 14" HANDLE

- Made of carbon steel
- Fully polished edge
- With protection for the edge



Oval eye

Code	Head weight	Inner	Master
TC0698	1.5 lb	4	12

Type of packaging: Bulk

WOOD HANDLE, FOR AXE

- Natural finish



For axe

Code	Size	Inner	Master
TC1471	36"	6	6

Type of packaging: Bulk

GARDENING | MACHETES

POLISHED STANDARD MACHETE

- Full length blade
- Polished blade
- Factory sharpening
- Riveted handle



Code	Size	Inner	Master
TC1209	14"	6	36
TC1210	16"	6	36
TC1211	18"	6	36
TC1212	20"	6	36
TC1213	22"	6	36
TC1214	24"	6	36
TC1215	26"	6	3

6 Type of packaging: Bulk

POLISHED STANDARD MACHETE

- Full length blade
- Polished blade
- Factory sharpening
- Injected handle



Code	Size	Inner	Master
TC4412	14"	6	36
TC4413	16"	6	36
TC4414	18"	6	36
TC4415	20"	6	36
TC4416	22"	6	36
TC4417	24"	6	36
TC4418	26"	6	3

6 Type of packaging: Bulk

POLISHED ACAPULQUEÑO MACHETE

- Full length blade
- Polished blade
- Factory sharpening
- Riveted handle



Code	Size	Inner	Master
TC1216	24"	6	36
TC1217	27"	6	36

Type of packaging: Bulk

POLISHED ACAPULQUEÑO MACHETE

- Full length blade
- Polished blade
- Factory sharpening
- Injected handle



Code	Size	Inner	Master
TC4419	24"	6	36
TC4420	27"	6	36

Type of packaging: Bulk

POLISHED CAGUAYANO MACHETE

- Full length blade
- Polished blade
- Factory sharpening
- Riveted handle



Code	Size	Inner	Master
TC1218	27"	6	36

Type of packaging: Bulk

POLISHED CAGUAYANO MACHETE

- Full length blade
- Polished blade
- Factory sharpening
- Injected handle



Code	Size	Inner	Master
TC4421	27"	6	36

Type of packaging: Bulk

MATTOCKS AND PICKAXES WITHOUT HANDLE

- High carbon forged steel
- Heat treatment
- Oval eye



Code	Weight	Characteristics	Inner	Master
TC0680	5 lb	PICKAXE	6	6
TC0681	5 lb	5 lb	6	6
TC0682	5 lb	Mattock / Axe	6	6

Type of packaging: Bulk

HANDLES FOR MATTOCK AND PICKAXE



· Oak treated wood

Code	Characteristics	Inner	Master
TC5273	Fiberglass 36"	1	12
TC1470	Wood 36"	6	6

Type of packaging: Bulk

MATTOCKS AND PICKAXE WITH HANDLE

- 36" handle
- Forged steel



Code	Handle	Weight	Inner	Master
TC0895	Wood	5 lb	4	6
TC5319	Fiberglass	3.7 lb	4	6

Type of packaging: Bulk

PICKAXE WITH HANDLE

- 36" handle
- Forged steel



Code	Handle	Weight	Inner	Master
*TC0894	Wood	5 lb	6	6
TC5318	Fiberglass	3.7 lb	6	6

Type of packaging: Bulk

MATTOCK WITH AXE HANDLE

- 36" handle
- Forged steel



Code	Handle	Weight	Inner	Master
TC0896	Wood	5 lb	4	6
TC5320	Fiberglass	3.6 lb	4	6

Type of packaging: Bulk

GARDENING | PRUNING SHEARS

TWO-HAND PRUNING SHEARS, NEOPRENE HANDLE

- Ground rectified forged steel blades
- Wing nut
- Plastic cover for blade protection included



* Pruning shears size indicates the whole product size: shears + handle

Code	Size	Inner	Master
TC1332	22"	4	6

Type of packaging: Bulk

TWO-HAND PRUNING SHEARS, WOOD HANDLE

- Ground rectified forged steel blades
- Plastic cover for blade protection included



* Pruning shears size indicates the whole product size: shears + handle

Code	Size	Inner	Master
TC1330	19"	6	24
TC1331	22"	6	24

Type of packaging: Bulk

TWO-HAND REINFORCED PRUNING SHEARS, TUBULAR HANDLE

- Ground forged steel blades
- PVC handle
- Plastic cover for blade protection included



* Pruning shears size indicates the whole product size: shears + handle

Code	Size	Inner	Master
TC4039	21"	6	24

Type of packaging: Bulk

TWO-HAND PRUNING SHEARS, TUBULAR HANDLE

- Ground rectified forged steel blades
- Foam handle
- Plastic cover for blade protection included



* Pruning shears size indicates the whole product size: shears + handle

Code	Size	Inner	Master
TC1333	22"	6	6

Type of packaging: Bulk

BYPASS LOPPER, WOOD HANDLE

- Ground steel blades
- Cutting capacity: 1 1/2"



* Pruning shears size indicates the whole product size: shears + handle

Code	Size	Inner	Master
TC4040	28"	3	24

Type of packaging: Bulk

BYPASS LOPPER, TUBULAR HANDLE

- Ground steel blades
- Cutting capacity: 1 1/2"



* Pruning shears size indicates the whole product size: shears + handle

Code	Size	Inner	Master
TC4041	28"	3	24

Type of packaging: Bulk

TWO-HAND PRUNING SHEARS, WOOD HANDLE

- Forged steel blades
- Plastic cover for blade protection included



* Pruning shears size indicates the whole product size: shears + handle

Code	Size	Inner	Master
WF1698	19"	6	24

Type of packaging: Bulk

Wolfox

BYPASS LOPPER, WOOD HANDLE

- Blades made of carbon steel
- Cutting capacity: 1 1/4"



* Pruning shears size indicates the whole product size: shears + handle

Code	Size	Inner	Master
WF9930	16"	6	24

Type of packaging: Bulk

Wolfox

TREE PRUNER, NO HANDLE

- Steel body
- Includes: 1 cutter, 1 blade, 1 rope of nylon and 1 plastic handle
- Tempered steel 14" (35 cm) serrated blade
- Compatible with TC2132 handle



Code	Content	Inner	Master
TC2130	1 1/4" (32 mm)	2	12
Spare parts			
TC2131	1 1/4" (32 mm)	3	20

Type of packaging: Blister

ALUMINUM TELESCOPIC POLE

- Includes sponge grip for easy handling
- Minimum extension: 1.28 m
- Maximum extension: 2.40 m
- Easy-to-adjust rotating mechanism
- Compatible with model TC2130



Code	Characteristics	Inner	Master
TC2132	Rotating adjustment	3	12

Type of packaging: Bag

FRUIT PICKER

- Vinyl coated
- Includes sponge to prevent fruit from bruising
- Includes clamp to secure handle
- Compatible with TC2132 handle



Code	Characteristics	Inner	Master
TC4038	Vinyl coated	1	6

Type of packaging: Bulk

4-PIECE GARDEN TOOL SET

- Heads made of tempered steel
- Contains one pitchfork, one cultivator, one transplanter and one frowel
- 152.4 mm (6") handle



*Price per roll

Code	Characteristics	Inner	Master
TC2724	Wooden handle	6	12

Type of packaging: Box

3-PIECE GARDEN TOOL SET

- Heads made of enameled metal
- Contains one frowel, cultivator, and one transplanter



Code	Characteristics	Inner	Master
WF5111	Plastic handle	6	24

Type of packaging: Bag

Wolfox

SCYTHER

- One single piece
- Protected edge
- Reinforced rib
- SCYTHER NO HANDLE

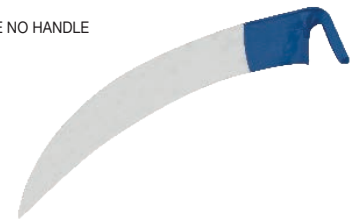

Code	Size	Inner	Master
TC2862	26"	2	12

Type of packaging: Bulk

ALUMINUM ANVIL PRUNING SHEARS

- Aluminum body



Code	Size	Inner	Master
TC1267	8"	6	72

Type of packaging: Blister

CURVED BYPASS PRUNING SHEARS

- Made of forged steel



Code	Size	Inner	Master
TC1265	6"	6	36
TC1263	8 1/2"	6	36

Type of packaging: Blister

AVOCADO PRUNING SHEARS

- Made of forged steel
- For harvesting avocados, mangos and delicate fruits



Code	Size	Inner	Master
TC1268	5 1/2"	6	36

Type of packaging: Blister

GRAPE PRUNING SHEARS

- Made of forged steel
- Pointed blades.



Code	Size	Inner	Master
TC1264	8"	6	36

Type of packaging: Blister

ALUMINUM CURVED PRUNING SHEARS

- Aluminum body



Code	Size	Inner	Master
TC1266	8 1/2"	6	72

Type of packaging: Blister

CURVED BLADE PRUNING SHEARS

- Aluminum body



Code	Size	Inner	Master
WF7708	8"	10	60

Type of packaging: Blister

Wolfox

SANDPAPERS

WOOD SANDING CABINET PAPER

- Aluminum oxide grits
- Cabinet paper
- 9 "x 11" sheets
- To be used manually or with a machine



Code	Thickness	Inner	Master
TC2824	36	12	250
TC2825	40	25	250
TC2826	50	25	250
TC2827	60	25	250
TC2828	80	25	250
TC2829	100	25	250
TC2830	120	25	250
TC2831	150	25	250
TC2832	180	25	250

Type of packaging: Case

RED EMERY CLOTH

- Cotton-base flexible cloth sheet
- Aluminum oxide grits
- Sheet: 9 "x 11"
- To be used in machine or manually



Code	Thickness	Inner	Master
TC2820	36	25	250
TC5233	40	25	250
TC2821	50	25	250
TC2822	80	25	250
TC5234	100	25	250
TC2823	120	25	250

Type of packaging: Case

WET SANDPAPER

- Made of 100% silicon carbide
- Waterproof paper
- Sheet: 9 "x 11"
- To be used in machine or manually
- For wet or dry treatment



Code	Thickness	Inner	Master
TC5235	60	25	250
TC2836	80	25	250
TC2837	100	25	250
TC2838	120	25	250
TC2839	150	25	250
TC2840	180	25	250
TC2841	220	25	250
TC2842	240	25	250
TC2843	280	25	250
TC2844	320	25	250
TC2845	360	25	250
TC2846	400	25	250
TC2847	500	25	250
TC2848	600	25	250
TC2849	1000	25	250
TC2850	1200	25	250
TC5236	1500	25	250
TC5237	2000	25	250

Type of packaging: Case

BLACK EMERY FILE

- Cotton-base flexible cloth sheet
- Aluminum oxide grits
- Sheet: 9 "x 11"
- To be used in machine or manually



Code	Thickness	Inner	Master
TC2816	36	25	250
TC2817	50	25	250
TC2818	80	25	250
TC2819	120	25	250

Type of packaging: Case

WOOD SANDING CLOTH, KRAFT PAPER

- Aluminum oxide grits
- Kraft paper
- Sheets: 9 "x 11"



Code	Thickness	Inner	Master
TC2833	60	25	250
TC2834	100	25	250
TC2835	150	25	250
TC3185	220	25	250

Type of packaging: Case

BLACK EMERY FILE SET , 10 PCS

- Cotton-base flexible cloth sheet
- Aluminum oxide grits
- Sheet: 9 "x 11"
- To be used in machine or manually
- Content:
 - 2 sheets grit 60
 - 3 sheets grit 80
 - 3 sheets grit 120
 - 2 sheets grit 150



Code	Thickness	Inner	Master
WF0674	50, 80 and 120	20	50

Type of packaging: Case



WET SANDPAPER FILE, 7 PCS

- Waterproof paper sheet
- 100% silicon carbide grits
- Sheet: 9" x 11"
- To be used in machine or manually
- For wet or dry treatment
- Content:
 - 1 sheet grit 80
 - 2 sheets grit 120
 - 1 sheet grit 150
 - 2 sheets grit 180
 - 1 sheet grit 220

Wolfox



Code	Thickness	Inner	Master
WF0676	80,100,120,180,220	20	50

Type of packaging: Case

DISPLAY RACK TOOLCRAFT FILES TYPE CHICO

- Main structure in 3 lime wire
- 8 trays made of lime wire 8 with borders holder sheet lime 24
- Application of electrostatic paint black color
- Digitally printed borders
- Measures:

Height: 65 cm
Width: 46 cm
Bottom: 27 cm

* Does not include product

Code	Capacity	Inner	Master
TC5439	8 models of sandpapers	1	1



ABRASIVE ROLL

- Roll width: 1 1/2"
- Aluminum oxide grits



Ferrous metal and non-ferrous

Code	Length	Thickness	Inner	Master
TC3183	5 m	120	12	48
TC3184	45 m	120	12	12

Type of packaging: Box

SANDPAPER DISCS WITH FIBER SUPPORT

- Made of aluminum oxide
- For use in angle grinder
- For roughing metal and wood
- Glue support



Cover
5 pcs
*Price per cover

Code	Diameter	Thickness	Inner	Master
TC5248	4 1/2"	24	5	25
TC5249	4 1/2"	36	5	25
TC5250	4 1/2"	50	5	25
TC5251	4 1/2"	80	5	25
TC5252	4 1/2"	120	5	25
TC5253	7"	24	5	25
TC5254	7"	36	5	25
TC5255	7"	50	5	25
TC5256	7"	80	5	25
TC5257	7"	120	5	25

Type of packaging: Box

SUPPORT FOR SAND DISKS

- With cooling channels for higher disc performance
- Made of polypropylene
- For use with self-adhesive sanding discs



Code	Screw	Inlet	Diameter	Inner	Master
TC5241	Standard	5/8"	4 1/2"	10	60
TC5242	Millimeter	M14	4 1/2"	10	60
TC5243	Standard	5/8"	7"	10	40
TC5244	Millimeter	M14	7"	10	40

Type of packaging: Hanger

4" X 24" ABRASIVE BELT

- Aluminum oxide grits
- 3-piece cover



For use in belt sanders

Cover
3 pcs
*Price per cover

Code	Thickness	Inner	Master
TC5226	36	4	20
TC5227	40	4	20
TC5228	50	4	20
TC5229	60	4	20
TC5230	80	4	20
TC5231	100	4	20
TC5232	120	4	20

Type of packaging: Case

3" X 21" ABRASIVE BELT

- Aluminum oxide grits
- 3-piece cover



For use in belt sanders

Cover
3 pcs
*Price per cover

Code	Thickness	Inner	Master
TC5224	36	4	20
TC2356	40	4	20
TC5225	50	4	20
TC2357	60	4	20
TC2358	80	4	20
TC2359	100	4	20
TC2360	120	4	20

Type of packaging: Case

FILES

CUT HEAVY TAPER FILE

- For filing hand saws, saws, machetes and sickles



Code	Size	Inner	Master
TC0183	4"	12	600
TC0184	5"	12	360
*TC0185	6"	12	300
TC0186	7"	12	180
TC0187	8"	12	180

Type of packaging: Bulk

REGULAR THREE-SQUARE FILE

- For filing hand saws and other cutting tools



Code	Size	Inner	Master
TC0190	6"	12	360
TC0191	7"	12	180
TC0192	8"	12	180

Type of packaging: Bulk

DOUBLE THREE-SQUARE FILE

- For filing cutting tools
- Includes detachable handle



Code	Size	Inner	Master
TC0198	6"	12	120
TC0202	7"	12	120
TC0199	8"	12	600

Type of packaging: Bulk

ROUND CHAINSAW FILE

- For filing chainsaw



Code	Size	Inner	Master
*TC0206	5/32" x 8"	12	600
TC0205	3/16" x 8"	12	600
TC0182	7/32" x 8"	12	600

Type of packaging: Bulk

BASTARD FLAT FILE

- For filing and finishing in metals

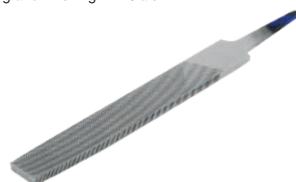

Code	Size	Inner	Master
TC0131	4"	12	720
TC0132	6"	12	360
TC0133	8"	12	180
TC0134	10"	12	120
TC0135	12"	6	72
TC0136	14"	6	60

Type of packaging: Bulk

MILL SAW FILE

- For filing and fine finishing of metals

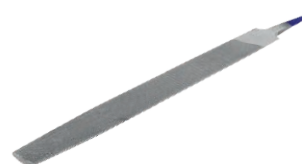

Code	Size	Inner	Master
TC0137	4"	12	720
TC0138	6"	12	360
TC0139	8"	12	180
TC0140	10"	12	120
TC0141	12"	6	72

Type of packaging: Bulk

BASTARD CUT HALF ROUND FILE

- For concave and convex surfaces
- For rapid roughing and rough edges



Code	Size	Inner	Master
TC0142	6"	12	360
TC0143	8"	12	216
TC0144	10"	6	144
TC0145	12"	6	72

Type of packaging: Bulk

SK00TU CUT HALF ROUND FILE

- For concave and convex surfaces
- For fast grinding in fine finishes



Code	Size	Inner	Master
TC0147	6"	12	360
TC0148	8"	12	192
TC0149	10"	4	120
TC0150	12"	6	72

Type of packaging: Bulk

ROUND BASTARD FILE

- For roughing holes and/or concave surfaces
- For rapid roughing and rough edges

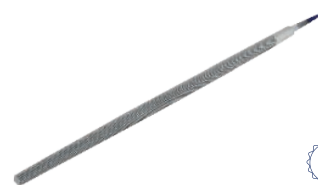

Code	Size	Inner	Master
TC0152	4"	12	720
TC0154	6"	12	720
TC0155	8"	12	300
TC0156	10"	12	216
TC0157	12"	6	120

Type of packaging: Bulk

SMOOTH CUT ROUND FILE

- For roughing holes and/or concave surfaces
- For grinding slabs in fine finishes



Code	Size	Inner	Master
TC0161	6"	12	720
TC0162	8"	12	300
TC0163	10"	12	216
TC0164	12"	6	120

Type of packaging: Bulk

HALF ROUND RASP FILE

- For roughing in soft materials such as wood, lead, aluminum, etc



Code	Size	Inner	Master
TC0174	Bastard 6"	6	300
TC0175	Bastard 8"	6	180
TC0176	Bastard 10"	6	120
TC0177	Bastard 12"	6	60

Type of packaging: Bulk

HALF ROUND WOOD RASP

- For roughing on soft materials



Code	Size	Inner	Master
TC0179	12"	4	60

Type of packaging: Bulk

HALF ROUND TIN FILE

- Special for roughing in bronze, lead, iron, aluminum, etc



Code	Size	Inner	Master
TC0181	14"	4	90

Type of packaging: Bulk

BASTARD CUT HALF ROUND FILE WITH HANDLE

- For concave and convex surfaces
- For rapid roughing and rough edges



Code	Size	Inner	Master
TC1484	6"	6	60
TC1485	8"	6	60

Type of packaging: Blister

BASTARD FLAT FILE WITH HANDLE

- For filing and finishing in metals



Code	Size	Inner	Master
TC1474	6"	6	60
TC1475	8"	6	60

Type of packaging: Blister

ROUND BASTARD FILE WITH HANDLE

- For roughing holes and/or concave surfaces
- For rapid roughing and rough edges



Code	Size	Inner	Master
TC1476	6"	6	60
TC1477	8"	6	60

Type of packaging: Blister

DOUBLE THREE-SQUARE FILE WITH HANDLE

- For filing cutting tools
- Includes detachable handle



Code	Size	Inner	Master
TC1478	6"	6	60
TC1479	8"	6	60

Type of packaging: Blister

CUT HEAVY TAPER FILE WITH HANDLE

- For handsaws, saws, machetes and sickles



Code	Size	Inner	Master
TC1480	6"	6	60
TC1481	8"	6	60

Type of packaging: Blister

REGULAR THREE-SQUARE FILE WITH HANDLE

- For filing handsaws and other cutting tools



Code	Size	Inner	Master
TC1482	6"	6	60
TC1483	8"	6	60

Type of packaging: Blister

HANDLE FOR FILE

- Handle with 4 different inserts

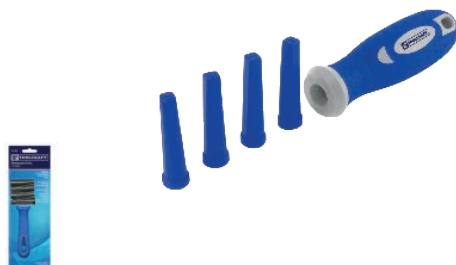

Inner shape	Inner shape
No. 0 8" Flat	No. 1 6" Simple flat
10" Simple flat	8" Simple flat
10" Flat	8" Half-cane
10" Half-cane	8" Wooden rasp
Inner shape	Inner shape
No. 3 6" Slim triangular	No. 4 6" Slim triangular
6" Round	6" Slim triangular
8" Round	
10" Round	

Code	Characteristics	Inner	Master
TC1486	5 pieces	6	60

Type of packaging: Blister

12-PIECE FILE SET

- Made of T8 steel
- For quick roughing, fine finishes and general use.
- Content:
 - 10" bastard flat file
 - 8" bastard cut half round file
 - 6" round bastard file
 - 8" mill saw file
 - 8" half round rasp file
 - 8" round rasp file
 - 8" manual lawnmower file
- 8" file rasp for tinsmith
- 6" slim taper file
- 6" extra-fine tip file
- 2 high impact handles



Code	Length	Inner	Master
WF0605	6", 8" y 10"	2	12

Type of packaging: Case

FILES | BATTERIES

5-PIECE FILES WITH HANDLE SET

- Made of T8 steel
- For quick roughing, fine finishes and general use.
- Content:
 - Bastard flat file
 - Bastard cut half round file
 - Round bastard file
 - Bastard three-square file
 - Bastard square file

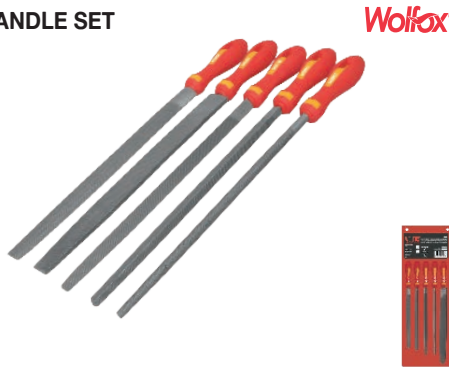

Wolfox

Code	Length	Inner	Master
WF0604	12"	3	12

Type of packaging: Case

12-PIECE METRIC FILE SET

- Made of T8 steel
- For precise work and general use
- Content:
 - Square flat file
 - Flat tip file
 - Half-round file
 - Three-square file
 - Round file
 - Square file
 - Oval file
 - Almond file
 - Knife file
 - Sword file

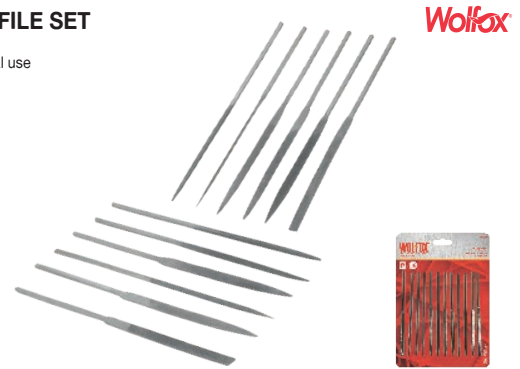

Wolfox

Code	Length	Inner	Master
WF0608	5 1/2"	6	72

Type of packaging: Blister

3-PIECE FILE SET

- Made of T8 steel
- For works on soft materials like wood, lead, and aluminum
- Content:
 - Flat rasp file
 - Half round rasp file
 - Round rasp file



Wolfox

Code	Length	Inner	Master
WF0607	8"	6	36

Type of packaging: Blister

3-PIECE CHAINSAW FILE SET

- Made of T8 steel
- For filing chainsaw
- Each file with handle included



Wolfox

Code	Length	Inner	Master
WF0606	8"	6	72

Type of packaging: Blister

9-VOLT ALKALINE BATTERY

- High performance



*Price per blister of 1 piece

Code	Characteristics	Inner	Master
TC3106	Alkaline	6	48

Type of packaging: Blister

D ALKALINE BATTERY

- High performance



*Price per blister of 2 pieces

Code	Characteristics	Inner	Master
TC3105	Alkaline	6	48

Type of packaging: Blister

C ALKALINE BATTERY

- High performance



*Price per blister of 2 pieces

Code	Characteristics	Inner	Master
TC3104	Alkaline	6	48

Type of packaging: Blister

AA ALKALINE BATTERY

- High performance



*Price per blister of 4 pieces

Code	Characteristics	Inner	Master
TC3103	Alkaline	10	80

Type of packaging: Blister

AAA ALKALINE BATTERY

- High performance



*Price per blister of 4 pieces

Code	Characteristics	Inner	Master
TC3102	Alkaline	10	80

Type of packaging: Blister



FLASHLIGHTS

WORKSHOP LED RECHARGEABLE FLASHLIGHT

- ABS body
- Input 120 V ~ 60 Hz
- Charger included
- Battery life: 3.5 hr
- Magnetic base
- Charging time: 8 hr



Duration
3.5 hr

Rechargeable

Code	LEDS	Lumens	Inner	Master
TC5385	12	140 lm	2	24

Type of packaging: Box

WORKSHOP LED FLASHLIGHT 16+6 LED

- Aluminum body
- Magnetic base
- 3 "AAA" batteries (Not included)
- (Not included)
 - 6 Led: 8 hr- 6 Led: 8 hr
 - 16 Led: 3 hr- 16 Led: 3 hr



Batteries

Code	LEDS	Lumens	Inner	Master
TC4564	22	65	2	60

Type of packaging: Blister

PEN LED FLASHLIGHT

- Aluminum body
- AAA" batteries (not included)
- Battery life: 3.5 hr



Batteries

Code	LEDS	Lumens	Inner	Master
TC5386	9	180 lm	4	48

Type of packaging: Card

PORTABLE RECHARGEABLE FLASHLIGHT 120 ML

- ABS body
- Input 120 V ~ 60 Hz
- Retractable plug
- Charging time: 12 hrs



Duration
4 hr

Rechargeable

To extend the life of your battery charge the battery every 40 days

Code	LEDS	Lumens	Inner	Master
TC3389	1	120 lm	6	36

Type of packaging: Blister

PORTABLE RECHARGEABLE FLASHLIGHT 70 ML

- ABS body
- Input 120 V ~ 60 Hz
- Retractable plug
- Charging time: 12 hrs



Duration
3 hr

Rechargeable

To extend the life of your battery charge the battery every 40 days

Code	LEDS	Lumens	Inner	Master
TC3388	1	70 lm	6	36

Type of packaging: Blister

ERGONOMIC RECHARGEABLE FLASHLIGHT

- ABS body
- Input 120 V ~ 60 Hz
- Retractable plug
- Charging time: 12 hrs

TC1921
Duration
5 hr



TC3387
Duration
3 hr

Rechargeable

To extend the life of your battery charge the battery every 40 days

Code	LEDS	Lumens	Inner	Master
TC1921	1	70 lm	12	60
TC3387	1	100 lm	6	36

Type of packaging: Blister

FLASHLIGHTS

ALUMINUM LED FLASHLIGHT

- Aluminum body
- 1 LED
- Impact resistant
- Batteries included



Battery life	
TC4368	2.5 hr
TC4369	8 hr
TC4370	12 hr



Code	Batteries	Lumens	Inner	Master
TC4368	2 AA	100 lm	4	48
TC4369	2 C	250 lm	4	24
TC4370	2 D	300 lm	4	12

Type of packaging: Blister

RECHARGEABLE FLASHLIGHT 130 lm

- ABS body
- Input 120 V ~ 60 Hz
- Retractable plug
- Charging time: 12 hrs



To extend the life of your battery charge the battery every 40 days



Code	LEDS	Lumens	Inner	Master
TC3386	1	130 lm	4	16

Type of packaging: Box

ALUMINUM LED FLASHLIGHT FOR HEAD

- ABS body
- Uses 3 AAA 1.5 V DC batteries (Not included)
- 8 LED head lamp
- 3 Lighting levels: low, high and intermittent
- Adjustable light angle



Code	Batteries	Lumens	Duration	Inner	Master
TC4371	3 AAA	60 lm	5 hr	6	48
TC4372	3 AAA	90 lm	3 hr	6	48
TC4373	3 AAA	120 lm	2.5 hr	4	48

Type of packaging: Blister

12 LED RECHARGEABLE HEAD LAMP

- ABS body
- Input 120 V ~ 60 Hz
- Retractable plug
- Adjustable to 90 °



To extend the life of your battery charge the battery every 40 days

Code	LEDS	Lumens	Inner	Master
TC3391	12	36 lm	4	60

Type of packaging: Box

8 LED RECHARGEABLE HEAD LAMP

- ABS body
- Uses 3 AAA 1.5 V DC batteries (Not included)
- 3 Lighting levels: 2,4 and 8 LED
- Adjustable to 90 °



Code	LEDS	Batteries	Lumens	Inner	Master
TC1925	8	3 AAA	35 lm	6	48

Type of packaging: Blister

FLASHLIGHT WITH BATTERIES 1 LED

- Made in plastic
- 1 LED
- Batteries included



Wolfax



Code	Batteries	Duration	Lumens	Inner	Master
WF0565	2 AA	8 hr	30	12	48
WF0566	2 D	20 hr	30	8	24
WF0567	3 D	48 hr	50	4	24

Type of packaging: Blister

RECHARGEABLE FLASHLIGHT 1 LED

- ABS body
- Input: 120 V ~ 60Hz
- Retractable plug



Wolfox



Code	LEDS	Lumens	Inner	Master
WF0569	1	50 lumens	12	48

Type of packaging: Blister

ALUMINUM FLASHLIGHT WITH BATTERIES, 9 LED

- Aluminum body
- 9 LEDS
- Use 3 AAA batteries (Not included)



Wolfox



Code	Batteries	Lumens	Inner	Master
WF0568	3 AAA	30 lumens	10	60

Type of packaging: Blister

RECHARGEABLE FLASHLIGHT LED

- ABS body
- Input 120 V ~ 60 Hz
- Retractable plug
- Charging time: 12 hrs



Wolfox



To extend the life of your battery charge the battery every 40 days



Code	LEDS	Duration	Lumens	Inner	Master
WF1637	1	5 hr	35	12	48
WF1639	1	7 hr	45	12	48

Type of packaging: Blister

ERGONOMIC LED RECHARGEABLE FLASHLIGHT

- ABS body
- Input 120 V ~ 60 Hz
- Retractable plug
- Charging time: 12 hrs



Wolfox



To extend the life of your battery charge the battery every 40 days



Code	LEDS	Lumens	Inner	Master
WF9641	1	35	12	96

Type of packaging: Blister

PLASTIC FLASHLIGHT 3 LED

- ABS body
- Use 2 "D" batteries (included)
- Display box of 12 pcs (4 pcs. of each color)
- Three colors: Yellow, red and green



Wolfox



Code	LEDS	lumens	Inner	Master
WF9512	3	9	12	48

Type of packaging: 12 pieces display

FRONT ALUMINUM TORCH FOR BICYCLE

- Aluminum and ABS body
- 3 batteries AAA (included)
- Ignition switch
- 3 functions: high, low and intermittent



NEW PRODUCT



Code	LEDS	Lumens	Inner	Master
TC5515	1	100 lm	6	24

Type of packaging: Blister

REAR PLASTIC FLASHLIGHT FOR BICYCLE

- ABS body
- 2 batteries AAA (included)
- Ignition switch
- Functions: fixed light and 4 different intermittent functions



NEW PRODUCT



Code	LEDS	Lumens	Inner	Master
TC5516	9	2 lm	12	48

Type of packaging: Blister

FLASHLIGHT SET FOR BICYCLE

- It has the following codes TC5515 and TC5516
- Flashlights include batteries



NEW PRODUCT



Code	Inner	Master
TC5517	6	24

Type of packaging: Blister

FRONT AND REAR FLASHLIGHTS SET FOR BICYCLE

- Made of flexible silicone
- 2 CR2032 batteries (included)
- Ignition switch
- 3 functions: fixed light, fast and slow flash



Wolfox

NEW PRODUCT



Code	LEDS	Lumens	Inner	Master
WF0783	2	6 and 2 lm	12	48

Type of packaging: Blister

WRENCHES

25-PIECE HEX KEY SET

- Made of carbon steel Cr-V steel
- Satin coating, corrosion-resistant



Standard	1/16"	5/64"	3/32"	7/64"	1/8"	9/64"
	5/32"	3/16"	7/32"	1/4"	5/16"	3/8"
Milimetric	1.5 mm	2 mm	2.5 mm	3 mm	3.5 mm	4 mm
	4.5 mm	5 mm	5.5 mm	6 mm	7 mm	8 mm
					9 mm	10 mm

Code	Measure	Inner	Master
TC4374	Metric / Standard	2	24

Type of packaging: Plastic case

7-PIECE LONG STANDARD HEX KEY SET

- Made of carbon steel Cr-V steel
- Satin coating, corrosion-resistant



Measures
TC4379
1/8"
5/32"
3/16"
7/32"
1/4"
5/16"
3/8"

Code	Measure	Inner	Master
TC4379	Standard	6	36

Type of packaging: Blister

7-PIECE LONG METRIC HEX KEY SET

- Made of carbon steel Cr-V steel
- Satin coating, corrosion-resistant



Measures
TC4380
2.5 mm
3 mm
4 mm
5 mm
6 mm
8 mm
10 mm

Code	Measure	Inner	Master
TC4380	Milimetric	6	36

Type of packaging: Blister

13-PIECE STANDARD HEX KEY SET

- Made of carbon steel Cr-V steel
- Satin coating, corrosion-resistant

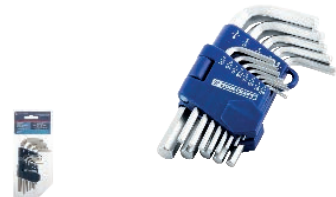

Measures
TC4375
3/64"
1/16"
5/64"
3/32"
7/64"
1/8"
9/64"
5/32"
3/16"
7/32"
1/4"
5/16"
3/8"

Code	Measure	Inner	Master
TC4375	Standard	6	36

Type of packaging: Blister

13-PIECE METRIC HEX KEY SET

- Made of carbon steel Cr-V steel
- Satin coating, corrosion-resistant



Measures
TC4376
1.3 mm 4.5 mm
1.5 mm 5 mm
2 mm 5.5 mm
2.5 mm 6 mm
3 mm 8 mm
3.5 mm 10 mm
4 mm

Code	Measure	Inner	Master
TC4376	Milimetric	6	36

Type of packaging: Blister

10-PIECE STANDARD HEX KEY SET

- Made of carbon steel Cr-V steel
- Satin coating, corrosion-resistant



Measures
TC4377
1/16"
5/64"
3/32"
1/8"
5/32"
3/16"
7/32"
1/4"
5/16"
3/8"

Code	Measure	Inner	Master
TC4377	Standard	6	36

Type of packaging: Blister

10-PIECE METRIC HEX KEY SET

- Made of carbon steel Cr-V steel
- Satin coating, corrosion-resistant



Measures
TC4378
1.5 mm
2 mm
2.5 mm
3 mm
4 mm
5 mm
5.5 mm
6 mm
8 mm
10 mm

Code	Measure	Inner	Master
TC4378	Milimetric	6	36

Type of packaging: Blister

9-PIECE TORX KEY SET

- Made of carbon steel Cr-V steel
- Satin coating, corrosion-resistant



Measures
TC4381
T-10
T-15
T-20
T-25
T-27
T-30
T-40
T-45
T-50

Code	Type	Inner	Master
TC4381	Torx	3	60

Type of packaging: Blister

8-PIECE FOLDING TORX KEY SET

- Made of carbon steel Cr-V steel
- Satin coating, resistant to corrosion



Measures
TC4382
T-9
T-10
T-15
T-20
T-25
T-27
T-30
T-40

Code	Type	Inner	Master
TC4382	Torx	6	60

Type of packaging: Blister

13 PIECE ALLEN WRENCH SET

- Made of carbon steel

Wolfox



Measures	
WF0572	
3/64"	5/32"
1/16"	3/16"
5/64"	7/32"
3/32"	1/4"
7/64"	5/16"
1/8"	3/8"
9/64"	

Code	Measure	Inner	Master
WF0572	Standard	6	36

Type of packaging: Blister

13-PIECE METRIC HEX KEY SET

- Made of carbon steel

Wolfox



Measures
WF0573
1.3 mm 4.5 mm
1.5 mm 5 mm
2 mm 5.5 mm
2.5 mm 6 mm
3 mm 8 mm
3.5 mm 10 mm
4 mm

Code	Measure	Inner	Master
WF0573	Milimetric	6	36

Type of packaging: Blister

10-PIECE STANDARD HEX KEY SET

- Made of carbon steel

Wolfox



Measures
WF0574
1/16"
5/64"
3/32"
1/8"
5/32"
3/16"
7/32"
1/4"
5/16"
3/8"

Code	Measure	Inner	Master
WF0574	Standard	6	36

Type of packaging: Blister

10-PIECE MILIMETRIC HEX KEY SET

- Made of carbon steel

Wolfox

Measures	
WF0575	
	1.5 mm
	2 mm
	2.5 mm
	3 mm
	4 mm
	5 mm
	5.5 mm
	6 mm
	8 mm
	10 mm



Code	Measure	Inner	Master
WF0575	Milimetric	6	36

Type of packaging: Blister

8-PIECE TORX KEY SET KNIFE TYPE

- Bar made of high carbon steel
- Razor-type case in chromed steel with metallic coating

Wolfox

Measures	
WF4545	
	T-9
	T-10
	T-15
	T-20
	T-25
	T-27
	T-30
	T-40



Code	Type	Inner	Master
WF4545	Torx	6	72

Type of packaging: Blister

8-PIECE HEX KEY SET

- Made of carbon steel
- Includes keyring type ring

Wolfox

Standard	Milimetric
WF4542	WF4571
1/16"	1.5 mm
5/64"	2 mm
3/32"	2.5 mm
1/8"	3 mm
5/32"	4 mm
3/16"	5 mm
7/32"	5.5 mm
1/4"	6 mm

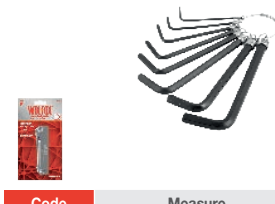

Code	Measure	Inner	Master
WF4542	Standard	12	96
WF4571	Milimetric	12	96

Type of packaging: Cover

STANDARD COMBINATION WRENCH

- Made of Cr-V steel
- Mirror finish



Mirror finish

Code	Measure	Length	Inner	Master
TC3836	1/4"	136 mm	6	36
TC3837	5/16"	148 mm	6	36
TC3838	3/8"	168 mm	6	36
TC3839	7/16"	182 mm	6	36
TC3840	1/2"	203 mm	6	36
TC3841	9/16"	215 mm	6	36
TC3842	5/8"	225 mm	6	36
TC3843	11/16"	243 mm	6	36
TC3844	3/4"	260 mm	6	36
TC3845	13/16"	282 mm	6	36
TC3846	7/8"	300 mm	6	36
TC3847	15/16"	325 mm	6	36
TC3848	1"	345 mm	6	36

Type of packaging: Hanger

METRIC COMBINATION WRENCH

- Made of Cr-V steel
- Mirror finish



Mirror finish

Code	Measure	Length	Inner	Master
TC3849	6 mm	136 mm	6	36
TC3850	7 mm	150 mm	6	36
TC3851	8 mm	158 mm	6	36
TC3852	9 mm	167 mm	6	36
TC3853	10 mm	167 mm	6	36
TC3854	11 mm	180 mm	6	36
TC3855	12 mm	190 mm	6	36
TC3856	13 mm	205 mm	6	36
TC3857	14 mm	215 mm	6	36
TC3858	15 mm	228 mm	6	36
TC3859	16 mm	228 mm	6	36
TC3860	17 mm	245 mm	6	36
TC3861	18 mm	245 mm	6	36
TC3862	19 mm	258 mm	6	36

Type of packaging: Hanger

STANDARD OPEN END WRENCH

- Made of Cr-V steel
- Mirror finish



Mirror finish

Code	Measure	Length	Inner	Master
TC3820	1/4" x 5/16"	106 mm	6	36
TC3821	5/16" x 3/8"	120 mm	6	36
TC3822	3/8" x 7/16"	135 mm	6	36
TC3823	7/16" x 1/2"	150 mm	6	36
TC3824	1/2" x 9/16"	150 mm	6	36
TC3825	9/16" x 5/8"	165 mm	6	36
TC3826	5/8" x 3/4"	170 mm	6	36
TC3827	5/8" x 11/16"	177 mm	6	36
TC3828	11/16" x 3/4"	194 mm	6	36

Type of packaging: Hanger

METRIC OPEN END WRENCH

- Made of Cr-V steel
- Mirror finish



Mirror finish

Code	Measure	Length	Inner	Master
TC3829	6 x 7 mm	110 mm	6	36
TC3830	8 x 9 mm	120 mm	6	36
TC3831	10 x 11 mm	130 mm	6	36
TC3832	12 x 13 mm	145 mm	6	36
TC3833	14 x 15 mm	160 mm	6	36
TC3834	16 x 17 mm	180 mm	6	36
TC3835	18 x 19 mm	195 mm	6	36

Type of packaging: Hanger

11-PIECE STANDARD COMBINATION WRENCH SET

- Made of carbon steel Cr-V steel
- Chrome finish



Chrome finish

Measures	Length
TC0285	
1/4"	139.9 mm
5/16"	152.3 mm
3/8"	167.5 mm
7/16"	183.4 mm
1/2"	205.9 mm
9/16"	217 mm
5/8"	230 mm
11/16"	245 mm
3/4"	260 mm
13/16"	282 mm
7/8"	302 mm

Code	Measure	Inner	Master
TC0285	Standard	1	12

Type of packaging: Case

11-PIECE METRIC COMBINATION WRENCH SET

- Made of carbon steel Cr-V steel
- Chrome finish



Chrome finish

Measures	Length
TC0286	
6 mm	137.7 mm
8 mm	152.3 mm
9 mm	167.5 mm
10 mm	167.2 mm
11 mm	183.2 mm
13 mm	206.1 mm
14 mm	217 mm
16 mm	229 mm
18 mm	247 mm
19 mm	261 mm
22 mm	304 mm

Code	Measure	Inner	Master
TC0286	Milimetric	1	12

Type of packaging: Case

WRENCHES

9-PIECE STANDARD COMBINATION WRENCH SET

- Made of carbon steel Cr-V steel
- Chrome finish



Measures	Length
TC0283	
1/4"	94.1 mm
5/16"	109.1 mm
3/8"	120.1 mm
7/16"	132.2 mm
1/2"	152.50 mm
9/16"	165.1 mm
5/8"	179.4 mm
11/16"	193.4 mm
3/4"	215.02 mm



Code	Measure	Inner	Master
TC0283	Standard	2	18

Type of packaging: Case

9-PIECE METRIC COMBINATION WRENCH SET

- Made of carbon steel Cr-V steel
- Chrome finish



Measures	Length
TC0284	
7 mm	102.9 mm
8 mm	108.7 mm
9 mm	114.1 mm
10 mm	118.7 mm
11 mm	131.2 mm
12 mm	1141.3 mm
13 mm	150.6 mm
14 mm	165.2 mm
15 mm	173.8 mm



Code	Measure	Inner	Master
TC0284	Millimetric	2	24

Type of packaging: Case

6-PIECE STANDARD OPEN END WRENCH SET

- Made of carbon steel Cr-V steel
- Chrome finish



Measures	Length
TC0281	
5/16"	108.5 mm
3/8"	1119 mm
7/16"	132.4 mm
1/2"	152.6 mm
9/16"	116.3 mm
5/8"	180.6 mm



Code	Measure	Inner	Master
TC0281	Standard	3	24

Type of packaging: Case

6-PIECE METRIC COMBINATION WRENCH SET

- Made of carbon steel Cr-V steel
- Chrome finish



Measures	Length
TC0282	
9 mm	111 mm
10 mm	116 mm
12 mm	141 mm
13 mm	150 mm
14 mm	164 mm
15 mm	170 mm



Code	Measure	Inner	Master
TC0282	Millimetric	1	24

Type of packaging: Case

6-PIECE STANDARD COMBINATION WRENCH SET

- Made of carbon steel Cr-V steel
- Chrome finish



Measures	Length
TC0287	
1/4" x 5/16"	109.2 mm
3/8" x 7/16"	135.6 mm
1/2" x 9/16"	152.9 mm
9/16" x 5/8"	165.6 mm
11/16" x 3/4"	201.1 mm
13/16" x 7/8"	218 mm



Code	Measure	Inner	Master
TC0287	Standard	2	24

Type of packaging: Case

6-PIECE METRIC COMBINATION WRENCH SET

- Made of carbon steel Cr-V steel
- Chrome finish



Measures	Length
TC0288	
6 mm x 8 mm	112 mm
10 mm x 11 mm	137 mm
12 mm x 13 mm	153 mm
14 mm x 15 mm	160 mm
17 mm x 19 mm	188 mm
20 mm x 22 mm	208 mm



Code	Measure	Inner	Master
TC0288	Millimetric	2	24

Type of packaging: Case

STANDARD COMBINATION WRENCH

- Made of Cr-V steel

Wolfcraft



Code	Measure	Length	Inner	Master
WF0156	1/4"	95 mm	12	72
WF0157	5/16"	100 mm	12	72
WF0158	3/8"	120 mm	12	72
WF0159	7/16"	130 mm	12	72
WF0160	1/2"	145 mm	12	72
WF0161	9/16"	165 mm	12	72
WF0162	5/8"	190 mm	12	72
WF0163	11/16"	205 mm	12	72
WF0164	3/4"	230 mm	12	72
WF0165	13/16"	260 mm	6	36
WF0166	7/8"	280 mm	6	36
WF0167	15/16"	310 mm	6	36
WF0168	1"	330 mm	6	36

Type of packaging: Hanger

METRIC COMBINATION WRENCH

- Made of Cr-V steel

Wolfcraft



Code	Measure	Length	Inner	Master
WF0169	6 mm	95 mm	12	72
WF0170	7 mm	95 mm	12	72
WF0171	8 mm	100 mm	12	72
WF0194	9 mm	110 mm	12	72
WF0195	10 mm	120 mm	12	72
WF0172	11 mm	130 mm	12	72
WF0173	12 mm	140 mm	12	72
WF0196	13 mm	145 mm	12	72
WF0174	14 mm	165 mm	12	72
WF0175	15 mm	175 mm	6	36
WF0176	16 mm	185 mm	6	36
WF0177	17 mm	205 mm	6	36
WF0178	18 mm	215 mm	6	36
WF0179	19 mm	230 mm	6	36

Type of packaging: Hanger

STANDARD OPEN END WRENCH

- Made of Cr-V steel

Wolfcraft



Code	Measure	Length	Inner	Master
WF0180	5/16" x 3/8"	120 mm	12	72
WF0181	3/8" x 7/16"	130 mm	12	72
WF0182	7/16" x 1/2"	145 mm	12	72
WF0183	1/2" x 9/16"	160 mm	12	72
WF0184	9/16" x 5/8"	180 mm	12	72
WF0185	5/8" x 3/4"	200 mm	6	36
WF0186	5/8" x 11/16"	180 mm	6	36
WF0187	11/16" x 3/4"	200 mm	6	36

Type of packaging: Hanger

METRIC OPEN END WRENCH

- Made of Cr-V Steel



Wolfox

Chrome finish

Code	Measure	Length	Inner	Master
WF0188	8 x 9 mm	120 mm	12	72
WF0189	10 x 11 mm	130 mm	12	72
WF0190	12 x 13 mm	145 mm	12	72
WF0191	14 x 15 mm	160 mm	12	72
WF0192	16 x 17 mm	180 mm	12	72
WF0193	18 x 19 mm	200 mm	6	36

Type of packaging: Hanger

11-PIECE COMBINATION WRENCH SET

- Made of carbon steel Cr-V steel
- Chrome finish

WF0201	WF0202
Standard	Milimetric
1/4"	6 mm
5/16"	7 mm
3/8"	8 mm
7/16"	9 mm
1/2"	10 mm
9/16"	11 mm
5/8"	12 mm
11/16"	13 mm
3/4"	14 mm
13/16"	15 mm
7/8"	16 mm



Chrome finish

Code	Measure	Inner	Master
WF0201	Standard	3	12
WF0202	Milimetric	3	12

Type of packaging: Case

9-PIECE COMBINATION WRENCH SET

- Made of carbon steel Cr-V steel
- Chrome finish

WF0199	WF0200
Standard	Milimetric
3/8"	8 mm
7/16"	9 mm
1/2"	10 mm
9/16"	11 mm
5/8"	12 mm
11/16"	13 mm
3/4"	14 mm
13/16"	15 mm
7/8"	17 mm



Chrome finish

Code	Measure	Inner	Master
WF0199	Standard	3	12
WF0200	Milimetric	3	12

Type of packaging: Case

5-PIECE, COMBINED WRENCH SET

- Made of carbon steel Cr-V steel
- Chrome finish



Chrome finish

WF0197	WF0198
Standard	Milimetric
3/8"	8 mm
7/16"	10 mm
1/2"	11 mm
9/16"	12 mm
5/8"	13 mm

Code	Measure	Inner	Master
WF0197	Standard	2	36
WF0198	Milimetric	2	36

Type of packaging: Case

5-PIECE WRENCH SET

- Made of carbon steel Cr-V steel
- Chrome finish



Chrome finish

WF0203	WF0204
Standard	Milimetric
1/4" x 5/16"	6 mm x 7 mm
3/8" x 7/16"	8 mm x 9 mm
1/2" x 9/16"	10 mm x 11 mm
19/32" x 11/16"	12 mm x 13 mm
5/8" x 3/4"	14 mm x 15 mm

Code	Measure	Inner	Master
WF0203	Standard	2	36
WF0204	Milimetric	2	36

Type of packaging: Case

GAS CHROMED WRENCH

- Made of Cr-V steel
- Handle with 3/8" square hole to be used on valves that do not have handle



Code	Measure	Inner	Master
TC0997	7/8"	10	80

Type of packaging: Plastic hanger

GAS WRENCH

- Made of steel
- Handle with 3/8" drilling to be used on valves that do not have a handle



Code	Measure	Inner	Master
WF9661	7/8"	20	120

Type of packaging: Bulk

UNIVERSAL WRENCH WITH CHAIN

- Body Made of steel carbon steel
- 43 cm chain
- Carbon steel chain
- For tighten / loosen threaded pipe accessories



Code	Maximum capacity (diameter)	Inner	Master
TC3370	4 5/16"	2	24

Type of packaging: Blister

PLUMBING WRENCH

- Made of carbon steel
- Moving head with 240° rotation
- Universal adjustment clamp



Code	Measure	Inner	Master
TC0381	12" (304 mm)	5	20

Type of packaging: Plastic hanger

WRENCHES

BLACK OXIDE ADJUSTABLE WRENCH

- Made of Cr-V steel
- Hardness 45 - 50 HRC
- Adjustable jaw with 2 scales: millimeters and inches
- Includes nut wrench



Code	Length	Wrench in handle	Maximum opening	Inner	Master
TC4132	6"	10 mm	20 mm	6	60
TC4133	8"	11 mm	25 mm	6	48
TC4134	10"	13 mm	30 mm	4	36
TC4135	12"	14 mm	35 mm	3	24
TC4136	15"	Not included	45 mm	1	4
TC4137	18"	Not included	35 mm	1	4

Type of packaging: Card, box (TC4136 and TC4137)

CHROME-PLATED ADJUSTABLE WRENCH

- Made of Cr-V steel
- Hardness 45 - 50 HRC
- Adjustable jaw with 2 scales: millimeters and inches
- Includes nut wrench



Code	Length	Wrench in handle	Maximum opening	Inner	Master
TC4153	6"	10 mm	24 mm	6	60
TC4154	8"	11 mm	30 mm	6	48
TC4155	10"	13 mm	35 mm	6	36
TC4156	12"	14 mm	40 mm	3	24

Type of packaging: Card

CHROME-PLATED ADJUSTABLE WRENCH WITH GRIP

- Made of carbon steel
- Hardness 40 - 44 HRC
- Adjustable jaw with 2 scales: millimeters and inches



Code	Length	Maximum opening	Inner	Master
TC4138	6"	20 mm	6	60
TC4139	8"	25 mm	6	48
TC4140	10"	30 mm	6	36
TC4141	12"	35 mm	4	24
TC4163	15"	45 mm	2	4

Type of packaging: Card

BLACK OXIDE ADJUSTABLE WRENCH

- Made of carbon steel
- Hardness 38 - 48 HRC
- Jaw engraved in 2 scales: millimeters and inches



Code	Length	Maximum opening	Inner	Master
WF0121	6"	19 mm	6	120
WF0122	8"	25 mm	6	96
WF0123	10"	30 mm	6	60
WF0124	12"	35 mm	3	36

Type of packaging: Blister

Wolfox

ADJUSTABLE CHROMED WRENCH

- Made of carbon steel
- Hardness 38 - 48 HRC
- Jaw engraved in 2 scales: millimeters and inches



Wolfox

Code	Length	Maximum opening	Inner	Master
WF4506	6"	19 mm	6	120
WF4508	8"	25 mm	6	96
WF4510	10"	30 mm	6	60
WF4512	12"	35 mm	3	36

Type of packaging: Blister

CHROME-PLATED ADJUSTABLE MINI WRENCH WITH GRIP

- Made of carbon steel
- Hardness 45 - 50 HRC
- Jaw engraved in 2 scales: millimeters and inches



Wolfox

Code	Length	Maximum opening	Inner	Master
WF0009	5"	19 mm	3	36
WF0010	6"	25 mm	3	36

Type of packaging: Card

INDUSTRIAL PIPE WRENCH (STILSON)

- Made of nodular steel
- Strong body
- Teeth hardness 55 - 60 HRC



Code	Length	Opening	Inner	Master
TC4157	8"	19 mm	3	18
TC4158	10"	25 mm	3	18
TC4159	12"	32 mm	3	18
TC4160	14"	38 mm	3	12
TC4161	18"	51 mm	2	6
TC4162	24"	64 mm	1	3
TC4142	36"	89 mm	1	3

Type of packaging: Bulk

PIPE WRENCH (STILSON)

- Made of nodular steel
- Teeth hardness 55 - 60 HRC



Wolfox

Code	Length	Opening	Inner	Master
WF4608	8"	19 mm	4	48
WF4610	10"	25 mm	4	36
WF4612	12"	32 mm	4	24
WF4614	14"	38 mm	2	12
WF4618	18"	51 mm	2	6
WF0087	24"	64 mm	2	6

Type of packaging: Bulk

GRAY TARP HEAVY DUTY

- Polyethylene tarp
- Multipurpose
- Riveted reinforcement
- Aluminum eyes
- Double stitching on the edges for greater endurance
- 14 x 14 threads per square inch
- Weight per square meter: 180 g



Previous code	New code	Measures (m)	Measures (feet)	Inner	Master
TC0815	TC5450	1.5m x 1.5m	4.9' x 4.9'	4	30
TC0816	TC5451	2m x 2m	6.6' x 6.6'	3	15
TC0637	TC5452	3m x 3m	9.8' x 9.8'	3	12
TC0817	TC5453	3m x 3m	9.8' x 9.8'	3	8
TC0636	TC5454	3m x 3m	9.8' x 9.8'	2	8
TC0818	TC5455	3m x 3m	9.8' x 9.8'	2	6
-	TC5456	4m x 4m	13.1' x 13.1'	1	6
TC0638	TC5457	4m x 4m	13.1' x 13.1'	1	4
TC0819	TC5458	4m x 4m	13.1' x 13.1'	1	4
TC0820	TC5459	4m x 4m	13.1' x 13.1'	1	4
-	TC5460	5m x 5m	16.4' x 16.4'	1	4
TC0821	TC5461	5m x 5m	16.4' x 16.4'	1	3
TC0822	TC5462	5m x 5m	16.4' x 16.4'	1	2
TC0823	TC5463	6m x 6m	19.7' x 19.7'	1	2
TC0824	TC5464	6m x 6m	19.7' x 19.7'	1	2
TC0825	TC5465	6m x 12m	19.7' x 19.7'	1	1
-	TC5466	7m x 7m	23' x 23'	1	1
-	TC5467	9m x 9m	29.5' x 29.5'	1	1
-	TC5468	12m x 12m	39.4' x 39.4'	1	1

Type of packaging: Bag

BLUE TARP

- Polyethylene tarp
- Multipurpose
- Riveted reinforcement
- Aluminum eyes
- 10 x 10 threads per square inch
- Weight per square meter: 110 g



Previous code	New code	Measures (m)	Measures (feet)	Inner	Master
WF6009	WF0737	1.5m x 1.5m	4.9' x 4.9'	6	50
WF6008	WF0738	2m x 2m	6.6' x 6.6'	4	30
WF6010	WF0739	3m x 3m	9.8' x 9.8'	4	20
WF6012	WF0740	3m x 3m	9.8' x 9.8'	4	10
WF6016	WF0741	3m x 3m	9.8' x 9.8'	4	10
WF6020	WF0742	3m x 3m	9.8' x 9.8'	2	10
-	WF0743	4m x 4m	13.1' x 13.1'	2	10
WF6017	WF0744	4m x 4m	13.1' x 13.1'	2	6
WF6021	WF0745	4m x 4m	13.1' x 13.1'	2	6
WF6024	WF0746	4m x 4m	13.1' x 13.1'	2	6
-	WF0747	5m x 5m	16.4' x 16.4'	2	5
WF6022	WF0748	5m x 5m	16.4' x 16.4'	1	5
WF6025	WF0749	5m x 5m	16.4' x 16.4'	1	5
WF6023	WF0750	6m x 6m	19.7' x 19.7'	1	5
WF6030	WF0751	6m x 6m	19.7' x 19.7'	1	2
WF6040	WF0752	6m x 12m	19.7' x 19.7'	1	2
-	WF0753	7m x 7m	23' x 23'	1	2
WF6041	WF0754	9m x 9m	29.5' x 29.5'	1	1

Type of packaging: Bag

GREEN TARP



- Polyethylene tarp
- Multipurpose
- Riveted reinforcement
- Aluminum eyes
- 10 x 10 threads per square inch
- Weight per square meter: 110 g

GREEN TARP

- Polyethylene tarp
- Multipurpose
- Riveted reinforcement
- Aluminum eyes
- 10 x 10 threads per square inch
- Weight per square meter: 110 g



BLUE TARP LIGHT DUTY



- Polyethylene tarp
- Multipurpose
- Aluminum eyes
- 7 x 7 threads per square inch
- Weight per square meter: 90 g



Previous code	New code	Measure (m)	Measure (feet)	Inner	Master
WF0019	WF0755	2m x 2m	6.6' x 6.6'	4	30
WF0020	WF0756	3m x 3m	9.8' x 9.8'	4	20
WF0021	WF0757	3m x 3m	9.8' x 9.8'	4	10
WF0022	WF0758	4m x 4m	13.1' x 13.1'	4	6
-	WF0759	4m x 4m	13.1' x 13.1'	2	6
WF0023	WF0760	5m x 5m	16.4' x 16.4'	2	5
WF0025	WF0761	6m x 12m	19.7' x 19.7'	1	2

Type of packaging: Bag

Previous code	New code	Measure (m)	Measure (feet)	Inner	Master
WF9278	WF0762	2m x 2m	6.6' x 6.6'	4	30
WF9279	WF0763	3m x 3m	9.8' x 9.8'	4	20
WF9280	WF0764	3m x 3m	9.8' x 9.8'	4	10
WF9281	WF0765	4m x 4m	13.1' x 13.1'	4	6
-	WF0766	4m x 4m	13.1' x 13.1'	2	6
WF9282	WF0767	5m x 5m	16.4' x 16.4'	2	5
WF9284	WF0768	6m x 12m	19.7' x 19.7'	1	2

Type of packaging: Bag

Previous code	New code	Measure (m)	Measure (feet)	Inner	Master
WF9805	WF0769	2m x 2m	6.6' x 6.6'	4	10
WF9806	WF0770	3m x 3m	9.8' x 9.8'	4	10
WF9807	WF0771	3m x 3m	9.8' x 9.8'	4	5
WF9809	WF0772	4m x 4m	13.1' x 13.1'	4	3
-	WF0773	4m x 4m	13.1' x 13.1'	2	3
WF9810	WF0774	5m x 5m	16.4' x 16.4'	2	3
-	WF0775	6m x 12m	19.7' x 19.7'	1	1

Type of packaging: Bag

HAMMERS

POLISHED CURVED CLAW HAMMER

- Made of high-carbon steel
- Hickory wood handle



Code	Head	Handle	Inner	Master
TC0648	7 oz	11"	4	36
TC0650	16 oz	12 5/8"	6	36
TC0651	20 oz	12 5/8"	6	36

Type of packaging: Bulk

POLISHED STRAIGHT CLAW HAMMER

- Made of high-carbon steel
- Hickory wood handle



Code	Head	Handle	Inner	Master
TC0018	16 oz	12 5/8"	6	36
TC0019	20 oz	12 5/8"	6	36

Type of packaging: Bulk

POLISHED CURVED CLAW FORGED HAMMER

- Made of high-carbon steel
- Forged in 1-piece
- Handle with neoprene cover that absorbs vibrations



Code	Head	Handle	Inner	Master
TC0026	16 oz	12 5/8"	6	36

Type of packaging: Bulk

SEMI-POLISHED CURVED CLAW HAMMER

- Made of high-carbon steel
- Tempered on the nail and cap
- Engraved with conical nail
- Ash wood handle



Code	Head	Handle	Inner	Master
TC3609	7 oz	11"	6	48
★TC0016	16 oz	12 5/8"	6	36
TC0017	20 oz	12 5/8"	6	36

Type of packaging: Bulk

SEMI POLISHED STRAIGHT CLAW HAMMER

- Made of high-carbon steel
- Tempered on the nail and cap
- Engraved with conical nail
- Ash wood handle



Code	Head	Handle	Inner	Master
TC0020	16 oz	12 5/8"	6	36
TC0021	20 oz	12 5/8"	6	36

Type of packaging: Bulk

CURVED CLAW FIBERGLASS HAMMER

- Fiberglass handle
- Neoprene covered that absorbs vibrations
- Head made of high-carbon steel



Code	Head	Handle	Inner	Master
TC0022	16 oz	12 5/8"	6	36

Type of packaging: Bulk

TUBULAR CURVED CLAW HAMMER

- Highly durable and resistant tubular handle
- Head made of high-carbon steel



Code	Head	Handle	Inner	Master
TC0356	16 oz	13 3/8"	6	36

Type of packaging: Bulk

TUBULAR STRAIGHT CLAW HAMMER

- Highly durable and resistant tubular handle
- Head made of high-carbon steel



Code	Head	Handle	Inner	Master
TC0357	16 oz	13 3/8"	6	36
TC0358	20 oz	13 3/8"	6	36

Type of packaging: Bulk

POLISHED CURVED CLAW HAMMER

- Made of high-carbon steel
- Handle with neoprene cover that absorbs vibrations



Code	Head	Handle	Inner	Master
TC0024	16 oz	12 5/8"	6	36

Type of packaging: Bulk

SEMI-POLISHED BALL-HAMMER

- Made of high-carbon steel
- Ash wood handle



Code	Head	Handle	Inner	Master
TC1601	8 oz	11"	6	36
TC1602	12 oz	11 3/4"	6	36
TC1603	16 oz	13 3/8"	6	36
TC1604	24 oz	14 3/16"	4	24
TC1605	32 oz	14 3/16"	4	24
TC1606	40 oz	14 3/16"	6	12

Type of packaging: Bulk

SEMI-POLISHED BRICK HAMMER

- Made of high-carbon steel
- Ash wood handle



Code	Head	Handle	Inner	Master
TC1607	24 oz	11"	6	24

Type of packaging: Bulk

SEMI-POLISHED TACK HAMMER

- Forged in high carbon steel
- Ash wood handle



Code	Head	Handle	Inner	Master
TC1608	7 oz	11"	4	48

Type of packaging: Bulk

HAMMERS | SLEDGE HAMMER | MALLET

CURVED CLAW HAMMER



- Made of high-carbon steel
- Tempered on the nail and cap
- Engraved with conical nail
- Wooden Handle



Code	Head	Handle	Inner	Master
WF9785	7 oz	11"	6	48
WF6416	16 oz	12 5/8"	6	48

Type of packaging: Bulk

STRAIGHT CLAW HAMMER



- Head made of high-carbon steel
- Engraved with conical nail
- Wooden Handle



Code	Head	Handle	Inner	Master
WF6417	16 oz	12 5/8"	6	48

Type of packaging: Bulk

TUBULAR CURVED CLAW HAMMER



- Made of high-carbon steel
- Handle with neoprene cover that absorbs vibrations



Code	Head	Handle	Inner	Master
WF1622	16 oz	12 5/8"	6	36

Type of packaging: Bulk

POLISHED CURVED CLAW MINI HAMMER WITH GRIP



- For reduced spaces



Code	Head	Handle	Inner	Master
WF5076	10 oz	4 1/2"	12	36

Type of packaging: Bulk

RUBBER MALLET



- Wooden handle
- Neoprene material for strong impacts without damaging or scratching the surface



Code	Head	Inner	Master
WF6438	8 oz	12	60
WF6446	16 oz	6	36
WF6454	24 oz	6	36

Type of packaging: Bulk

3-PIECE RUBBER MALLET SET



- Wooden handle
- Neoprene material for strong impacts without damaging or scratching the surface



Code	Head	Inner	Master
WF6430	8,16 y 32 oz	2	12

Type of packaging: Box

SLEDGE HAMMER, FIBERGLASS HANDLE

- Made of high-carbon forged steel
- Head hardness (HRC): 45-50
- Octagonal design



Code	Head	Handle	Inner	Master
TC5068	2 lb	12"	6	12
TC5070	3 lb	12"	6	12
TC5071	4 lb	12"	6	12
TC5072	6 lb	36"	2	6
TC5073	8 lb	36"	2	4
TC5074	10 lb	36"	1	2
TC5075	12 lb	36"	1	2
TC5076	14 lb	36"	1	2
TC5124	16 lb	36"	1	2

Type of packaging: Bulk

SLEDGE HAMMER, WOOD HANDLE

- Made of high-carbon forged steel
- Head hardness (HRC): 45-50
- Octagonal design



Code	Head	Handle	Inner	Master
TC0558	2 lb	12"	6	12
TC0559	3 lb	12"	6	12
TC0560	4 lb	12"	6	12
TC0561	6 lb	36"	2	6
TC0562	8 lb	36"	2	4
TC0563	10 lb	36"	1	2
TC0564	12 lb	36"	1	2
TC0565	14 lb	36"	1	4
TC0566	16 lb	36"	1	2

Type of packaging: Bulk

CORBELS | MULTI-TOOLS | POCKET KNIVES

WHITE CORBEL

- Made of one piece steel blade
- 6 attachment points



Code	Measure	Thickness	Inner	Master
TC0918	4" x 5"	0.8 mm	24	288
TC0919	5" x 6"	0.8 mm	24	288
TC0920	6" x 8"	1 mm	24	288
*TC0921	8" x 10"	1 mm	24	144
*TC0922	10" x 12"	1 mm	24	144
TC0923	12" x 14"	1 mm	24	12

Type of packaging: Bulk

BROWN CORBEL

- Made of one piece steel blade
- 6 attachment points



Code	Measure	Thickness	Inner	Master
TC0930	4" x 5"	0.8 mm	24	288
TC0931	5" x 6"	0.8 mm	24	288
TC0932	6" x 8"	1 mm	24	288
TC0933	8" x 10"	1 mm	24	144
TC0934	10" x 12"	1 mm	24	144
TC0935	12" x 14"	1 mm	24	12

Type of packaging: Bulk

BLACK CORBEL

- Made of one piece steel blade
- 6 attachment points



Code	Measure	Thickness	Inner	Master
TC2509	4" x 5"	0.8 mm	24	288
TC2510	5" x 6"	0.8 mm	24	288
TC2511	6" x 8"	1 mm	24	288
TC2512	8" x 10"	1 mm	24	144
TC2513	10" x 12"	1 mm	24	144
TC2514	12" x 14"	1 mm	24	12

Type of packaging: Bulk

GRAY CORBEL

- Made of one piece steel blade
- 6 attachment points



Code	Measure	Thickness	Inner	Master
TC0924	4" x 5"	0.8 mm	24	288
TC0925	5" x 6"	0.8 mm	24	288
TC0926	6" x 8"	1 mm	24	288
TC0927	8" x 10"	1 mm	24	144
TC0928	10" x 12"	1 mm	24	144
TC0929	12" x 14"	1 mm	24	12

Type of packaging: Bulk

MULTITOOL 14 FUNCTIONS

- Stainless steel blade
- Case included



Functions
Fine-tip clamp
Pliers
Wire cutter
Nail cleaner
Knife
Bottle opener
3 slotted screwdrivers
Phillips screwdriver
Parallel file
Crossed file
Saw
Can opener

Code	Characteristics	Inner	Master
WF0287	14 functions in 1	4	48

Type of packaging: Blister

MULTITOOL 13 FUNCTIONS

- Stainless steel blade
- Case included



Functions
Fine-tip clamp
Pliers
Wire cutter
Nail cleaner
Knife
Bottle opener
3 slotted screwdrivers
Phillips screwdriver
File
Saw
Can opener

Code	Characteristics	Inner	Master
WF0288	13 functions in 1	4	48

Type of packaging: Blister

21-IN-1 FUNCTION SWISS- STYLE ARMY KNIFE

- Stainless steel body
- Nylon storage pouch included



Functions
3 knives
Phillips screwdriver
Magnifying glass
Saw
Fish scaler
Hook discharger
Clamps
3 screwdrivers
Can opener
Bottle opener
File
Corkscrews
Mini screwdriver
Leather perforator
Leather threader
Chisel
Fine screwdriver

Code	Characteristics	Inner	Master
TC0674	21 functions in 1	3	24

Type of packaging: Blister

15-IN-1 FUNCTION SWISS- STYLE ARMY KNIFE

- Stainless steel body



Functions
Knife
Fish scaler
Phillips screwdriver
Corkscrews
Bottle opener
Flat screwdriver
Scissors
Can opener
Needle threader
File
Saw
Clamps
Hook discharger
Leather perforator
Nails cleaner
Fine screwdriver

Code	Characteristics	Inner	Master
TC0673	15 functions in 1	6	24

Type of packaging: Blister

10-IN-1 FUNCTION, SWISS-STYLE ARMY KNIFE

- Made in stainless steel



Functions
Knife
Fish scaler
Phillips screwdriver
Corkscrews
Bottle opener
Screwdriver
Scissors
Can opener
File
Saw

Code	Characteristics	Inner	Master
TC0672	10 functions in 1	6	24

Type of packaging: Blister

ONE BLADE 6" PENKNIFE

- Made in stainless steel
- Safety lock



Code	Blade	Inner	Master
TC0676	173 mm	3	48

Type of packaging: Blister

ONE BLADE 5" PENKNIFE

- Made in stainless steel
- Safety lock



Code	Blade	Inner	Master
TC0675	140 mm	6	48

Type of packaging: Blister

4" KNIFE WITH LED

- Made in stainless steel
- LED light
- Safety lock



Code	Characteristics	Inner	Master
TC0677	Knife with light	3	48

Type of packaging: Blister

5" RUBBER HANDLE KNIFE

- Made in stainless steel
- Nylon storage pouch included
- Safety lock



Code	Characteristics	Inner	Master
TC0678	Handle knife / rubber	6	48

Type of packaging: Blister

6" CUTTER KNIFE

- Zinc body
- Extra long model with metal core
- Cutting multi-functions
- Adjustable safety with knob



Code	Blade width	Inner	Master
TC0585	18 mm	6	72
Replacement			
TC0598	18 mm (10 pieces)	24	240

Type of packaging: Blister

7" CUTTER KNIFE

- ABS body
- Metal core
- Automatic lock
- 3 replacement blades



Code	Blade width	Inner	Master
TC4383	25 mm	12	72
Replacement			
TC4388	25 mm (10 pieces)	3	144

Type of packaging: Blister

6" CUTTER KNIFE

- ABS body
- Metal core
- Automatic lock
- 3 replacement blades

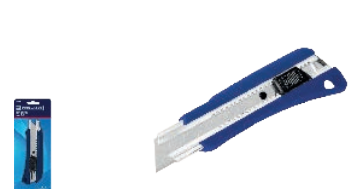

Code	Blade width	Inner	Master
TC4384	18 mm	12	72
Replacement			
TC0598	18 mm (10 pieces)	24	240

Type of packaging: Blister

7" CUTTER KNIFE

- Dual-material body, ABS and TPR.
- Metal core
- Automatic lock



Code	Blade width	Inner	Master
TC0579	18 mm	12	144
Replacement			
TC0598	18 mm (10 pieces)	24	240

Type of packaging: Blister

5" CUTTER KNIFE

- ABS body
- Automatic lock
- 1 Spare blade



Code	Blade width	Inner	Master
TC4385	9 mm	12	72
Replacement			
TC0597	9 mm (10 pieces)	24	360

Type of packaging: Bag

PRECISION HOBBY KNIFE

- Aluminum body with ABS handle
- Blade of 39 x 8 mm
- 5 spare knives



Code	Blade width	Inner	Master
TC4386	39 x 8 mm	12	48
Replacement			
TC4387	39 x 8 mm (10 pieces)	12	96

Type of packaging: Blister

6" RETRACTABLE KNIFE

- ABS body
- 8 replacement blades

Wolfox



Code	Blade width	Inner	Master
WF1372	19 mm	12	144

Type of packaging: Blister

6" CUTTER KNIFE

- ABS body
- Blade included
- Automatic lock

Wolfox

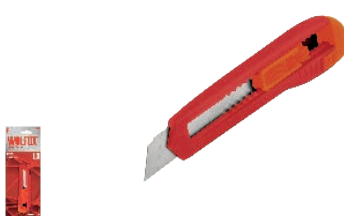

Code	Blade width	Inner	Master
WF1349	18 mm	24	288
Replacement			
TC0598	18 mm (10 pieces)	24	240

Type of packaging: Blister

7" CUTTER KNIFE

- ABS body
- Metal core
- Automatic lock

Wolfox



Code	Blade width	Inner	Master
WF0580	18 mm	12	144
Replacement			
TC0598	18 mm (10 pieces)	24	240

Type of packaging: Blister

5" CUTTER KNIFE

- ABS body
- Metal core
- Automatic lock

Wolfox



Code	Blade width	Inner	Master
WF0578	9 mm	24	288
Replacement			
TC0597	9 mm (10 pieces)	24	360

Type of packaging: Blister

5" CUTTER KNIFE

- ABS body
- Blade included
- Automatic lock

Wolfox



Code	Blade width	Inner	Master
WF1348	9 mm	24	576
Replacement			
TC0597	9 mm (10 pieces)	24	360

Type of packaging: Blister

PRECISION HOBBY KNIFE SET

- Metal handles
- Includes:
 - 3 handles
 - 13 blades
 - Plastic case

Wolfox



Code	Content	Inner	Master
WF0579	17 pieces	6	48

Type of packaging: Blister

LEVELS | WELDING

PROFESSIONAL ALUMINUM LEVEL

- Aluminum body
- Sides with plastic reinforcements
- 3 drops model: 0°, 45°, 90°
- Optical green drops
- Joist type design



Code	Length	Inner	Master
TC5184	12"	6	60
TC5185	14"	6	60
TC5186	18"	6	60
TC5187	24"	6	60
TC5188	36"	2	30
TC5189	48"	2	30

Type of packaging: Bulk

ALUMINUM LEVEL

- Anodized aluminum body
- Sides with plastic reinforcements
- 3 drops model: 0°, 45°, 90°
- Top reading window
- Drops of optical yellow color
- Joist type design



Wolfox

Code	Length	Inner	Master
WF6714	14"	6	60
WF6719	18"	6	60
WF6724	24"	6	60

Type of packaging: Bulk

LEVEL WITH LASER

- Dual-material
- 2 drops model
- Laser range: 10 meters
- Adjustable angle
- Includes 2 AAA batteries



Code	Characteristics	Inner	Master
TC2714	Magnetic base	2	12

Type of packaging: Blister

THREAD LEVEL

- Light model
- Drop visible from any angle
- 2-piece set



Code	Length	Inner	Master
TC2063	3"	10	60

Type of packaging: Blister

95/5 RESIN CORE SOLDER

- High resistance to pressure and temperature
- For gas installations, air conditioning and heating
- Composition: 95% acrylic, 5% antimony



Code	Weight	Fusion point	Diameter	Inner	Master
TC5095	450 g	240° C	3 mm	2	60

Type of packaging: Reel

60/40 RESIN CORE SOLDER

- For electronic works
- Composition: 60% tin and 60% lead



Code	Weight	Fusion point	Diameter	Inner	Master
TC5096	450 g	190° C	1 mm	2	60

Type of packaging: Reel

MAGNETIC TORPEDO LEVEL

- Aluminum and ABS body
- Magnetic base
- 3 drops model: 0°, 45°, 90°
- Top reading window

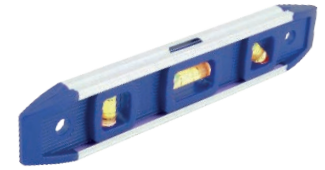

Code	Length	Inner	Master
TC0459	9"	12	60

Type of packaging: Blister

MAGNETIC TORPEDO LEVEL

- ABS body
- Magnetic stripe
- 3 drops model: 0°, 45°, 90°
- Top reading window

Wolfox



Code	Length	Inner	Master
WF6709	9"	12	60

Type of packaging: Blister

GAS LIGHTER TORCH TYPE

- Ideal for hard to reach places
- Ignition safety lock
- Fuel included (butane gas)
- Rechargeable

Wolfox



Code	Characteristics	Inner	Master
*WF9729	Adjustable flame	5	150

Type of packaging: Blister

50/50 RESIN CORE SOLDER

- For hydraulic installations
- Composition: 50% tin and 50% lead



Code	Weight	Fusion point	Diameter	Inner	Master
TC5097	450 g	209° C	3 mm	2	60

Type of packaging: Reel

BUTANE / PROPANE GAS CAN WITH THREAD

- For blowtorches, lighters, lamps and small stoves



Thread

Code	Content	Inner	Master
TC3383	247 g	12	12

Type of packaging: Can

BUTANE GAS TORCH

- Made of brass
- Flame adjusting knob
- Heat diffuser



Code	Length	Inner	Master
TC3380	12 cm	4	48

Type of packaging: Blister

BUTANE GAS BURNER THREADED

- Brass nozzle and aluminum tube
- Flame adjusting knob



Code	Length	Inner	Master
TC4628	20.5 cm	5	30

Type of packaging: Blister

BUTANE / PROPANE GAS CAN

- For blowtorches, lighters, lamps and small stoves



1/4 turn

Code	Content	Inner	Master
TC4563	247g	12	12

Type of packaging: Can

BUTANE GAS TORCH

- Made of brass
- Flame adjusting knob
- Heat diffuser



Code	Length	Inner	Master
TC4630	12 cm	4	36

Type of packaging: Blister

BUTANE GAS BURNER

- Brass nozzle and aluminum tube
- Flame adjusting knob



Code	Length	Inner	Master
TC4629	20.5 cm	5	30

Type of packaging: Blister

TORCH WITH GAS HOSE

- Brass nozzle
- PVC hose 5/16 "x 2 m
- Connector pig tail 7/8 "



Code	Torch length	Inner	Master
TC4631	36 cm	2	20

Type of packaging: Box

PORTABLE GAS STOVE

- Made of steel and aluminum burner
- Electronic ignition
- Works with 1/4 turn butane / propane gas can (TC4563)
- Automatic shut-off when there is high gas pressure
- Gas can not included



Code	Gas inlet	Inner	Master
TC4615	1/4 turn	2	6

Type of packaging: Plastic case

LP GAS GRILL

- Cover, grills and porcelain burners
- Electrostatic painting
- Manual Power On
- Light and portable
- 2 double grills
- Adjustable flame



Code	Characteristics	Inner	Master
WF0707	4 burners	1	1

Type of packaging: Box

Wolfbox

LP GAS GRILL

- Manual Power On
- Light and portable
- Burners with independent knobs
- Adjustable flame
- Cover, grills and burners
- Electrostatic painting



Code	Characteristics	Inner	Master
WF1680	2 burners	2	2

Type of packaging: Box

Wolfbox



SHOVELS

SQUARE SHOVEL

- 16 gauge blade
- Backward drolled steps
- "Y" handle (TC0404, TC5285)
- Handle of treated oak wood



TC0404

TC5285

TC0405

TC5286

ROUND POINT SHOVEL

- 16 gauge blade
- Backward drolled steps
- "Y" handle (TC0406, TC5287)
- Handle of treated oak wood



TC0406

TC5287

TC0407

TC5288

Code	Handle	Blade (width / height)	Full length	Inner	Master
*TC0404	Short Wood	23.5 cm / 29.5 cm	1.02 m	6	6
TC5285	Short Fiberglass	23.5 cm / 29.5 cm	1.02 m	3	6
TC0405	Length Wood	23.5 cm / 29.5 cm	1.50 m	6	6
TC5286	Length Fiberglass	23.5 cm / 29.5 cm	1.50 m	3	6

Type of packaging: Bulk

Code	Handle	Blade (width / height)	Full length	Inner	Master
TC0406	Short Wood	22 cm / 29.5 cm	1.02 m	6	6
TC5287	Short Fiberglass	22 cm / 29.5 cm	1.02 m	3	6
*TC0407	Length Wood	22 cm / 29.5 cm	1.50 m	3	6
TC5288	Length Fiberglass	22 cm / 29.5 cm	1.50 m	3	6

Type of packaging: Bulk

SCOOP SHOVEL

- 16 gauge blade
- Backward drolled steps
- "Y" handle
- Blade: width 31.7 cm / height 41cm
- Handle of treated oak wood



TC0409

TC5290

Code	Handle	Full length	Inner	Master
TC0409	Wood	1.12 m	3	6
TC5290	Fiberglass	1.12 m	3	6

Type of packaging: Bulk

GARDEN SHOVEL

- 16 gauge blade
- Backward drolled steps
- "Y" handle (TC0408)
- Blade: width 16.5 cm / height 30.5cm
- Handle of treated oak wood



TC0408

TC5289

TC5384

Code	Handle	Full length	Inner	Master
TC0408	Short Wood	1.02 m	6	6
TC5289	Short Fiberglass	1.02 m	6	6
TC5384	Length Wood	1.50 m	3	6

Type of packaging: Bulk

WOOD HANDLE FOR SHOVEL

- Natural finish
- "Y" handle
- Handle of treated oak wood



For shovel

Code	Length	Inner	Master
TC2856	53.5 cm (21")	6	25

Type of packaging: Bulk

SQUARE SHOVEL

- 18 gauge blade
- Backward drolled steps
- "Y" handle (WF9546)
- Treated hardwood handle

Wolfax



WF9546

WF0732

Code	Handle	Blade (width / height)	Length total	Inner	Master
WF9546	Short	23.3 cm / 27.5 cm	1.02 m	6	6
WF0732	Length	23.3 cm / 27.5 cm	1.50 m	6	6

Type of packaging: Bulk

ROUND POINT SHOVEL

- 18 gauge blade
- Backward drolled steps
- "Y" handle (WF9545)
- Treated hardwood handle

Wolfax



WF9545

WF0731

Code	Handle	Blade (width / height)	Length total	Inner	Master
WF9545	Short	20.4 cm / 28.4 cm	1.02 m	6	6
WF0731	Length	20.4 cm / 28.4 cm	1.50 m	3	6

Type of packaging: Bulk

GARDEN SHOVEL

- 18 gauge blade
- Backward drolled steps
- "Y" handle (WF0729)
- Treated hardwood handle

Wolfax



WF0729

WF0730

Code	Handle	Blade (width / height)	Length total	Inner	Master
WF0729	Short	16.5 cm / 30 cm	1.02 m	6	6
WF0730	Length	16.5 cm / 30 cm	1.50 m	3	6

Type of packaging: Bulk

STONES

SHARPENING STONE

- Made of silicon carbide
- Combined stone, one sharpening side and one polishing side
- For sharpening and flattening cutting tools
- Thickness: 1"
- Grits: 150 / 240

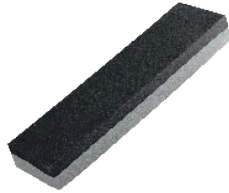

Code	Measure	Inner	Master
TC5082	150 mm x 50 mm	6	36
TC5083	200 mm x 50 mm	6	36

Type of packaging: Box

SHARPENING STONE



- Made of aluminum oxide
- Combined stone, one sharpening side and one polishing side
- For sharpening and flattening cutting tools
- Thickness: 1"
- Grits: 120 / 180

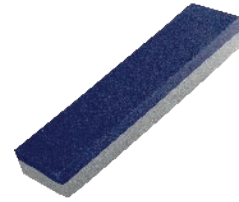

Code	Measure	Inner	Master
WF0614	150 mm x 50 mm	10	50
WF0615	200 mm x 50 mm	10	50

Type of packaging: Box

STONE FOR SCYTHES AND MACHETE

- Made of aluminum oxide
- For sharpening and beveling by hand of scythes, machetes, sickles, etc.
- Thickness: 5/8"
- Grits: 150



Code	Measure	Inner	Master
TC5084	235 mm x 35 mm	6	36

Type of packaging: Box

STONE FOR ESMERIL

- Aluminum oxide body
- Drill hole: 1/2"
- General uses
- Roughing and sharpening



Code	Grit	Diameter	Thickness	Max RPM	Inner	Master
TC2437	36	5"	1/2"	5,600	6	24
TC5177	36	5"	3/4"	5,600	6	24
TC2438	36	6"	3/4"	4,700	6	24
TC2439	60	6"	3/4"	4,700	6	24
TC2440	36	6"	1"	4,700	6	24
TC5178	36	8"	1"	3,350	2	12
TC2441	60	6"	1"	4,700	6	24
TC5179	60	8"	1"	3,350	2	12

Type of packaging: Box

10-PIECE MOUNTED GRINDING POINTS KIT

- Made of aluminum oxide
- 6.44 mm shank (1/4")
- For fine grinding works with mototool



For your safety never surpass the number of rpm set

Code	Grit	Inner	Master
TC4616	60 (medium)	6	36

Type of packaging: Blister

5-PIECE MOUNTED GRINDING POINTS KIT

- Made of aluminum oxide
- 6.44 mm shank (1/4")
- For fine grinding works with mototool



For your safety never surpass the number of rpm set

Code	Grit	Inner	Master
TC2448	60 (medium)	6	36

Type of packaging: Blister

Cutting speed

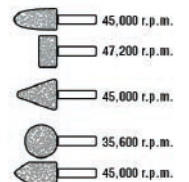

NODULAR IRON "C" TYPE PRESS

- Machined spindle with "T" handle
- Heavy duty



Code	Maximum opening	Inner	Master
TC1451	1"	12	144
TC1452	2"	12	72
TC1453	3"	6	36
TC1454	4"	6	36
TC1455	5"	6	24
TC1456	6"	6	24
TC1457	8"	2	12

Type of packaging: Bulk

TYPE "C" DIE-CUT PRESS

- Made of steel sheet
- Machined spindle with handle slider in "T"
- For light duty use



Code	Maximum opening	Inner	Master
TC2851	2"	6	72
TC2852	2 1/2"	6	36
TC2853	3"	6	36

Type of packaging: Bulk

EDGE PRESS

- Made of aluminum
- Holds material at right angles
- Adjusting screw made of steel



Code	Maximum opening	Clamping force	Inner	Master
TC5301	3"	400 lbs	6	24

Type of packaging: Card

SPRING PRESS

- Made of nylon
- Handles with TPR
- PVC jaws



Code	Maximum opening	Total Length	Clamping force	Inner	Master
TC5299	2"	160 mm	22 lbs	6	36
TC5300	3"	210 mm	26.4 lbs	4	24

Type of packaging: Card

FAST PRESS

- Handle in ABS and nylon press
- Polyethylene jaws
- Heat-treated bar for greater resistance
- Pressure release button
- Depth: 55 mm



Code	Maximum opening	Clamping force	Inner	Master
WF0708	6"	99 lbs	4	16
WF0709	12"	99 lbs	4	16

Type of packaging: Card

SPRING PRESS 2 " 2 Pieces

- Made of nylon
- PVC jaws



Code	Maximum opening	Clamping force	Inner	Master
WF0711	2"	17.6 lbs	4	24

Type of packaging: Card

SPRING PRESS 1 " 6 Pieces

- Made of nylon
- PVC jaws



Code	Maximum opening	Clamping force	Inner	Master
WF0710	1"	6.6 lbs	4	24

Type of packaging: Card



PAINTING AND ITEMS TO PAINT

PROFESSIONAL BRUSH

- For all types of paint, enamel, varnish and lacquers
- Plastic handle
- 100% natural bristle



Code	Measure	Bristle length	Inner	Master
TC5275	1/2"	48 mm	12	72
TC5276	1"	48 mm	12	72
TC5277	1 1/2"	48 mm	12	72
TC5278	2"	48 mm	12	72
TC5279	2 1/2"	48 mm	12	72
TC5280	3"	53 mm	12	72
TC5281	4"	60 mm	12	72
TC5282	5"	66 mm	6	72
TC5283	6"	66 mm	6	72

Type of packaging: Bag

PREMIUM BRUSH

- For all types of paint, enamel, varnish and lacquers
- Plastic handle
- 100% natural bristle



Code	Measure	Bristle length	Inner	Master
TC1494	1/2"	44 mm	12	144
TC1495	1"	44 mm	12	144
TC1496	1 1/2"	44 mm	12	144
*TC1497	2"	44 mm	12	72
TC1498	2 1/2"	44 mm	12	72
TC1499	3"	48 mm	12	72
*TC1500	4"	55 mm	12	48
TC1501	5"	60 mm	6	48
TC1502	6"	60 mm	6	48

Type of packaging: Bag

BRUSH PLASTIC HANDLE

- Plastic handle
- Bristle 80% natural and 20% artificial

Wolfox



Code	Measure	Bristle length	Inner	Master
WF0901	1/2"	38 mm	12	72
WF0902	1"	38 mm	12	72
WF0903	1 1/2"	38 mm	12	72
WF0904	2"	38 mm	12	72
WF0905	2 1/2"	38 mm	12	72
WF0906	3"	40 mm	12	72
*WF0907	4"	44 mm	12	72
*WF0908	5"	48 mm	12	72
WF0909	6"	48 mm	12	72

Type of packaging: Bag

BRUSH WOODEN HANDLE

Wolfox

- For paints, resins, glues, acetones and other solvents.
- 100% natural bristle



Code	Measure	Bristle length	Inner	Master
WF0716	1"	38 mm	12	360
WF0717	1 1/2"	38 mm	12	360
WF0718	2"	38 mm	12	288
WF0719	2 1/2"	38 mm	12	288
WF0720	3"	38 mm	12	240
WF0721	4"	38 mm	12	144

Type of packaging: Bag

9" HIGH DENSITY PAINT ROLLER

- High absorption capacity
- For the use of water based paints, on rough and smooth surfaces
- Handle with internal thread



Code	Plush	Thickness	Inner	Master
TC4552	9"	5/8"	24	24
TC4553	9"	3/4"	24	24
TC4554	9"	1"	24	24
TC4555	9"	1 1/4"	24	24

Type of packaging: Bag

9" LOW DENSITY PAINT ROLLER

- High absorption capacity
- For the use of water based paints, on rough and smooth surfaces
- Handle with internal thread



Code	Plush	Thickness	Inner	Master
TC2793	9"	5/8"	24	24
TC2794	9"	3/4"	24	24
TC2795	9"	1"	24	24
TC2796	9"	1 1/4"	24	24

Type of packaging: Bag

9" HIGH DENSITY ROLLER COVER

- High absorption capacity
- For the use of water based paints, on rough and smooth surfaces



Code	Plush	Thickness	Inner	Master
TC4556	9"	5/8"	12	24
TC4557	9"	3/4"	12	24
TC4558	9"	1"	12	24
TC4559	9"	1 1/4"	12	24

Type of packaging: Bag

9" LOW DENSITY ROLLER COVER

- High absorption capacity
- For the use of water based paints, on rough and smooth surfaces



Code	Plush	Thickness	Inner	Master
TC2797	9"	5/8"	12	24
TC2798	9"	3/4"	12	24
TC2799	9"	1"	12	24
TC2800	9"	1 1/4"	12	24

Type of packaging: Bag

9" PAINT ROLLER FRAME

- 5 1/4" galvanized wire bars
- Anti-slip plastic end caps
- Reinforcement threaded handle

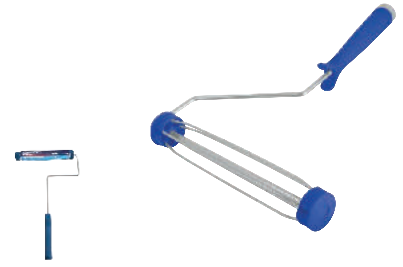

Code	Plush	Inner	Master
TC2801	9"	24	24

Type of packaging: Bag

4" FOAMPAINROLLER

- For all paint and dye types
- For retouching and reduced spaces with smooth surfaces
- Handle with internal thread



Code	Foam	Thickness	Inner	Master
TC4560	4"	3/8"	12	48

Type of packaging: Bag

4" FOAM PAINT ROLLER COVERS, 10-PIECE SET

- For all paint and dye types
- For retouching and reduced spaces with smooth surfaces



*Price per blister of 10 pieces

Code	Foam	Thickness	Inner	Master
TC4561	4"	3/8"	6	60

Type of packaging: Blister

4" SINGLE PAINT ROLLER FRAME

- For 4" plush and foam
- For retouching and reduce spaces



Code	Measure	Inner	Master
TC4562	4"	12	48

Type of packaging: Bag

PLASTIPROTECTOR

- Made in polypropylene.
- Multipurpose
- Recommended to protect furniture when painting

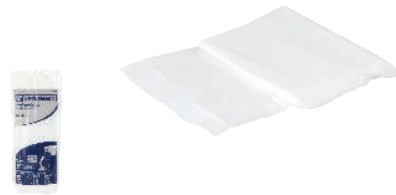

Code	Measure	Use	Gauge	Inner	Master
TC5201	5 m x 3 m	Light	0.016 mm	6	48
TC5200	5 m x 2 m	Heavy	0.020 mm	6	48

Type of packaging: Bag

ALUMINUM EXTENSION FOR ROLLER

- Telescopic extension
- Tip with thread to assemble in rollers and brushes to paint



Code	Maximum length	Inner	Master
TC2802	2 m	6	24
TC2803	2.7 m	6	24

Type of packaging: Bag

PAINT ROLLER TRAY

- Made of high impact polypropylene
- Cross lines help remove paint excess on the roller



Code	Measure	Inner	Master
TC2804	28 x 39 cm	20	20

Type of packaging: Bulk

SET OF ROLLER, BRUSH AND TRAY

- Tray made of polypropylene
- Low density plush roller (9")
- 2" brush (WF0904)

Wolfax



Code	Tray Measure	Inner	Master
WF0623	26 x 35 cm	10	10

Type of packaging: Shrinking

SET OF ROLLER AND TRAY

- Tray made of polypropylene
- Low density plush roller (9")

Wolfax



Code	Tray Measure	Inner	Master
WF0622	26 x 35 cm	1	10

Type of packaging: Shrinking

PAINT ROLLER TRAY

- Made of polypropylene
- Cross lines help remove paint excess on the roller

Wolfax



Code	Measure	Inner	Master
WF0621	26 x 35 cm	20	40

Type of packaging: Bulk

PAINTINGS | AEROSOL SPRAYS

SPRAY PAINT, BASIC COLORS

- For indoor and outdoor use
- Fast dry
- Content: 400 ml / 280 g / 13.5 oz
- Does not contain lead

In all the catalog of spray paint
Mayor rendimiento
Mejor cobertura



Does not harm the ozone layer

Can of 400 ml

Code	Color	Inner	Master
TC1657	Light acrylic	6	12
TC1658	Sunflower yellow	6	12
TC1661	Ochre yellow	6	12
TC1654	Blue	6	12
TC1674	Light blue	6	12
TC1647	Royal blue	6	12
TC1653	Beige	6	12
TC4342	Ivory	6	12
*TC1642	Glossy White	6	12
TC1650	Matte White	6	12
TC1673	Scalloped white	6	12
TC1656	Wood brown	6	12
TC1649	Machine gray	6	12
TC1668	Opaque gray	6	12
TC1671	Light violet	6	12
TC1660	Orange	6	12
TC1670	Chevy orange	6	12
*TC1641	Glossy black	6	12
*TC1643	Matte black	6	12
TC3595	Satin black	6	12
*TC1644	Bright red	6	12
TC4344	Vermillion	6	12
TC1667	Bright pink	6	12
TC1652	Dark green	6	12
TC1675	Fresh green	6	12
TC4343	Ecological green	6	12

Type of packaging: Can

SPRAY PAINT, METAL COLORS

- For indoor and outdoor use
- Fast dry
- Content: 400 ml / 280 g / 13.5 oz
- Does not contain lead



Does not harm the ozone layer

Can of 400 ml

Code	Color	Inner	Master
TC1645	Aluminum	6	12
TC1646	Chrome	6	12
TC1655	Silver	6	12
TC1648	Bright gold	6	12
TC1651	Cadillac gold	6	12
TC1659	Blue	6	12
TC1664	Green	6	12
TC1665	Pure copper	6	12
TC3596	Red	6	12

Type of packaging: Can

SPRAY PAINT, FLUORESCENT COLORS

- For indoor and outdoor use
- Fast dry
- Anti-corrosive
- Content: 400 ml / 280 g / 13.5 oz
- Does not contain lead



Does not harm the ozone layer

Can of 400 ml

Code	Color	Inner	Master
TC1663	Orange	6	12
TC1666	Green	6	12
TC1669	Pink	6	12
TC1672	Yellow	6	12

Type of packaging: Can

HAMMERED SPRAY PAINT

- For indoor and outdoor use
- Fast dry
- Painting with acrylic resin
- Hammered texture
- Content: 400 ml / 280 g / 13.5 oz
- Does not contain lead



Does not harm the ozone layer

Can of 400 ml



Code	Color	Inner	Master
TC4578	Gray	6	12
TC4579	Blue	6	12
TC4580	Green	6	12

Type of packaging: Can

PAINT BASIC COLORS

- For indoor and outdoor use
- Fast dry
- Content: 300 ml / 200 g / 10 oz
- Does not contain lead

Wolfbox



Does not harm the ozone layer

Code	Color	Inner	Master
WF0692	Light acrylic	12	12
WF0693	Sunflower yellow	12	12
WF0685	Royal blue	12	12
WF0680	Glossy White	12	12
WF0688	Matte White	12	12
WF0691	Wood brown	12	12
WF0687	Machine gray	12	12
WF0679	Glossy black	12	12
WF0681	Matte black	12	12
WF0706	Satin black	12	12
WF0682	Bright red	12	12
WF0689	Dark green	12	12

Type of packaging: Can

HIGH TEMPERATURE PAINT

- Ideal for grills, motors, etc.
- Fast dry
- Content: 400 ml / 280 g / 13.5 oz
- Resists 500 °C
- Does not contain lead



Does not harm the ozone layer

Can of 400 ml

Code	Color	Inner	Master
TC3603	Black	6	12
TC3604	Aluminum	6	12

Type of packaging: Can

ANTI-CORROSIVE PAINT

- For indoor and outdoor use
- Use as base before painting
- Fast dry
- Content: 400 ml / 280 g / 13.5 oz
- Does not contain lead



Does not harm the ozone layer

Can of 400 ml

Code	Color	Inner	Master
TC3597	Gray	6	12
TC3598	Red	6	12

Type of packaging: Can

SPRAY PAINT, METAL COLORS

- For indoor and outdoor use
- Fast dry
- Content: 300 ml / 200 g / 10 oz
- Does not contain lead



Does not harm the ozone layer



Code	Color	Inner	Master
WF0684	Chrome	12	12
WF0705	Silver	12	12
WF0686	Bright gold	12	12

Type of packaging: Can

SPRAY CAN FLOOR DISPLAY RACK

- PTR structure with foil and wire
- Arts in digital printing labeled on steel sheet.
- Electrostatic paint blue color
- Measures:

Height: 155 cm
Width: 50.5 cm
Depth: 42.5 cm



* Does not include product

Code	Capacity	Inner	Master
TC5435	60 cans	1	1

SPRAY CAN COUNTER DISPLAY RACK

- Structure in wire and sheet with electrostatic painting finish
- Assemble of 2 pieces thermoformed in styrene
- Measures:

Height: 56 cm
Width: 30 cm
Depth: 28.5 cm



* Does not include product

Code	Capacity	Inner	Master
TC5434	20 cans	1	1

ENAMEL PAINT

- High performance
- Maximum adherence
- Glossy finish
- For indoor and outdoor use



LATEX PAINT

- Performance: 4 to 6 m² x liter
- Washable
- Quality: 3 years
- For indoor and outdoor use



5-YEAR WATERPROOFING ROOF COATING

- New technology: no reinforcement mesh needed
- Performance: 1 m² x liter
- Drying time: 1.5 - 3 hr
- Made of acrylic styrene resin



TC4337

EXTRACT SEALER 4 LTS

- Seals porosities on the substratum
- Use it before applying roof coating
- Performance: 3 m² x liter



TC4341

Code	Color	Content	Inner	Master
TC3220	Canary Yellow	250 ml	6	6
TC3221	Canary Yellow	500 ml	6	6
TC3222	Canary Yellow	1 L	6	6
TC3273	Chrome Yellow	250 ml	6	6
TC3274	Chrome Yellow	500 ml	6	6
TC3275	Chrome Yellow	1 L	6	6
TC3224	Holland Blue	250 ml	6	6
TC3225	Holland Blue	500 ml	6	6
TC3226	Holland Blue	1 Liter	6	6
TC3228	Glossy White	250 ml	6	6
TC3229	Glossy White	500 ml	6	6
TC3230	Glossy White	1 L	6	6
TC3231	Glossy White	1 Gallon	2	2
TC3282	Matte White	250 ml	6	6
TC3283	Matte White	500 ml	6	6
TC3284	Matte White	1 L	6	6
TC3234	Brown	250 ml	6	6
TC3235	Brown	500 ml	6	6
TC3236	Brown	1 L	6	6
TC3285	Ivory	250 ml	6	6
TC3286	Ivory	500 ml	6	6
TC3287	Ivory	1 L	6	6
TC3240	Glossy black	250 ml	6	6
TC3241	Glossy black	500 ml	6	6
TC3242	Glossy black	1 L	6	6
TC3243	Glossy black	1 Gallon	2	2
TC3279	Matte black	250 ml	6	6
TC3280	Matte black	500 ml	6	6
TC3281	Matte black	1 L	6	6
TC3244	Red	250 ml	6	6
TC3245	Red	500 ml	6	6
TC3246	Red	1 L	6	6
TC3276	Oxide red	250 ml	6	6
TC3277	Oxide red	500 ml	6	6
TC3278	Oxide red	1 L	6	6
TC3248	Green	250 ml	6	6
TC3249	Green	500 ml	6	6
TC3250	Green	1 L	6	6

Type of packaging: Can

Code	Color	Content	Inner	Master
TC4422	White	4 L	1	1
*TC4423	White	19 L	1	1
TC4424	Lime green	4 L	1	1
TC4425	Orange	19 L	1	1
TC4426	Orange	4 L	1	1
TC4427	Orange	19 L	1	1
TC4428	Tangerine	4 L	1	1
TC4429	Tangerine	19 L	1	1
TC4430	Medium blue	4 L	1	1
TC4431	Medium blue	19 L	1	1
TC4432	Intense yellow	4 L	1	1
TC4433	Intense yellow	19 L	1	1
TC4434	Ivory	4 L	1	1
TC4435	Ivory	19 L	1	1
TC4672	Black	4 L	1	1

Type of packaging: Bucket

CORROSION-RESISTANT ENAMEL PRIMER

- Use as base before painting
- High performance
- Maximum adherence
- Coating power
- Matte finish
- For indoor and outdoor use



Code	Color	Content	Inner	Master
TC3232	Red	1 L	6	6
TC3233	Red	4 L	2	2
TC3253	Gray	1 L	6	6
TC3254	Gray	4 L	2	2

Type of packaging: Can

IXTLE MULTIPURPOSE BRUSH

- Wooden brush
- Handle with thread



Code	Length	Inner	Master
TC4531	1.46 m	1	1

Type of packaging: Bulk

SPRAY GUNS

PROFESSIONAL HIGH PRESSURE SPRAY GUN

- Aluminum gun body and cup
- Cup size: 0.95 liters
- 1.8 mm adjustable nozzle
- 1/4" air inlet



Code	Pressure	Air consumption	Inner	Master
TC4170	43 - 72 PSI	2 - 5 CFM	1	10

Type of packaging: Box

PROFESSIONAL HIGH PRESSURE SPRAY GUN

- Aluminum gun body and cup
- Cup size: 0.95 liters
- 1.8 mm adjustable nozzle
- 1/4" air inlet



Code	Pressure	Air consumption	Inner	Master
TC1842	43 - 72 PSI	2 - 5 CFM	2	10

Type of packaging: Box

LOWER PRESSURE SPRAY GUN

- Body made of aluminum alloy
- Cup size: 1 liter
- Reinforced ring cup
- 1.2 mm nozzle
- 1/4" air inlet



Code	Pressure	Air consumption	Inner	Master
TC4171	36 PSI	1 - 2 CFM	2	10

Type of packaging: Box

LOWER PRESSURE SPRAY GUN

- Aluminum gun body and cup
- Cup size: 1 liter
- Reinforced ring cup
- 1.3 mm nozzle
- 1/4" air inlet



Code	Pressure	Air consumption	Inner	Master
TC1841	36 PSI	1 - 2 CFM	2	10

Type of packaging: Box

PROFESSIONAL GRAVITY FEED SPRAY GUN

- Plastic cup
- Cup size: 0.6 liters
- Fan opening:
 - With 1.4 mm nozzle = 160 mm
 - With 1.7 mm nozzle = 160 mm
 - With 2 mm nozzle = 220 mm
- 1/4" air inlet
- Air pressure and paint-flow control



Code	Pressure	Air consumption	Inner	Master
TC1840	43 - 72 PSI	2 - 5 CFM	1	10

Type of packaging: Box

GRAVITY FEED SPRAY GUN

- Plastic cup
- Cup size: 0.6 liters
- Fan opening: 170mm
- 1/4" air inlet
- Air pressure and paint-flow control



Code	Pressure	Air consumption	Inner	Master
TC1839	43 - 72 PSI	2 - 5 CFM	2	10

Type of packaging: Box

GRAVITY FEED TOUCH-UP SPRAY GUN

- Plastic cup
- Cup size: 0.12 liters
- Fan opening: 160mm
- 1 mm nozzle
- 1/4" air inlet
- Air pressure and paint-flow control



Code	Pressure	Air consumption	Inner	Master
TC4172	29 - 50 PSI	2 - 4.5 CFM	2	10

Type of packaging: Box

GRAVITY FEED SPRAY GUN

- Aluminum cup
- Cup size: 0.4 liters
- 1.8 mm nozzle
- 1/4" air inlet



Code	Pressure	Air consumption	Inner	Master
TC1838	43 - 72 PSI	2 - 5 CFM	2	10

Type of packaging: Box

GRAVITY FEED MINI SPRAY GUN

- Aluminum cup
- Cup size: 0.2 liters
- 0.5 mm nozzle
- 1/4" air inlet
- Fan opening: 50mm



Code	Pressure	Air consumption	Inner	Master
TC1837	36 PSI	1 - 2 CFM	2	8

Type of packaging: Box

LOW PRESSURE TOUCH-UP SPRAY GUN

- Aluminum gun body and cup
- Cup size: 0.2 liters
- 1.5 mm nozzle
- 1/4" air inlet



Code	Pressure	Air consumption	Inner	Master
TC4174	43 - 72 PSI	2 - 5 CFM	2	10

Type of packaging: Box

AIR COATING SPRAY GUN

- Aluminum body
- 9.6 mm nozzle
- Suction feed
- 1/4" air inlet
- For 25 and 50 liter tanks
- Cup not included



Code	Pressure	Air consumption	Inner	Master
TC4173	30 - 120 PSI	2 - 5 CFM	5	20

Type of packaging: Box

ELECTRIC PAINT SPRAYER

- 120V - 60 Hz
- 800 ml polypropylene cup
- Ergonomic handle
- Adjustable 3-way fan nozzle
 - Vertical
 - Horizontal
 - Circular
- Adjustable paint flow
- Adjustable nozzle 1.8 - 2.6 mm
- Dispersion range 25 cm
- Includes 1.8 m hose



- Work cycle
 - 30 min of work per
 - 15 min rest
- Maximum daily 3 hr

Code	Power	Max flow.	Inner	Master
TC5471	800 W	300 ml/min	1	4

Type of packaging: Box

AIRBRUSH GUN

- 7 ml cup
- 1/4" air inlet
- 0.3 mm nozzle
- Gravity feed
- Air pressure and paint-flow control



Code	Pressure	Inner	Master
TC4176	30 - 70 PSI	1	30

Type of packaging: Case

HOSE FOR AIRBRUSH GUN

- 1.8 m length
- Thread: 1/4" NPT
- Internal diameter: 5/32" (4 mm)
- Material: Nylon
- External diameter: 8mm



Code	Length	Inner	Master
TC4178	1.8 m	6	36

Type of packaging: Blister

ACCESSORIES FOR AIRBRUSH GUN

- 0.3 mm nozzle with needle
- For fine spraying and continuous paint flow



Code	Compatible with	Inner	Master
TC4177	TC4176	6	36

Type of packaging: Blister

SPARE PART SET HIGH PRESSURE

- Contains 14 pieces:
- 1 spring
- 1 liquid nozzle
- 1 needle
- 2 retaining lock
- 3 gaskets
- 6 rings



Code	Characteristics	Inner	Master
TC1845	14 pieces	6	36

Type of packaging: Blister

SPARE PART SET LOW PRESSURE

- Contains 9 pieces:
- 1 needle
- 1 liquid nozzle
- 2 fan nozzle
- 5 gaskets



Code	Characteristics	Inner	Master
TC1844	9 pieces	6	36

Type of packaging: Blister

SPARE CUP, LOW PRESSURE

- Cup size: 0.950 liters



Code	Compatible with	Inner	Master
TC1843	TC1841	2	10

Type of packaging: Box

ELECTRIC PAINT SPRAYER

- 800 ml polypropylene cup
- Ergonomic handle
- Adjustable fan nozzle
- Air flow control
- 120 V-60 Hz

Wolfbox



Code	Power	Flow	Inner	Master
WF0598	110 W	350 ml / min	1	5

Type of packaging: Box

GROUND PLIER

- Galvanized steel body with chrome plated finish
- Brass connections and clamps
- Double safety system for cable



Code	Amperage	Inner	Master
TC0339	300 Amperes	5	50
TC0340	500 Amperes	5	50

Type of packaging: Box

GROUND PLIER

- Galvanized steel body with chrome plated finish
- Brass connections and clamps
- Double safety system for cable

Wolfbox



Code	Amperage	Inner	Master
WF0645	300 Amperes	6	36
WF0646	500 Amperes	6	36

Type of packaging: Box

ELECTRODE HOLDER

- High temperature resistant fiber glass coating
- Brass connections and clamps
- Different positions available for placing the electrode
- Includes 1 hex key



Code	Amperage	Caliber cable	Inner	Master
TC5239	300 Amperes	2/0 AWG	4	16
TC5240	500 Amperes	4/0 AWG	2	16

Type of packaging: Box

ELECTRODE HOLDER

- High temperature resistant fiber glass coating
- Brass connections and clamps
- Different positions available for placing the electrode
- Includes 1 hex key



Code	Amperage	Caliber cable	Inner	Master
WF0643	300 Amperes	3 AWG	6	36
WF0644	500 Amperes	2 AWG	6	36

Type of packaging: Box

PLIERS

PROFESSIONAL ELECTRICIAN PLIERS DUAL MATERIAL HANDLES

- Made of #55 carbon steel
- Satin polished finish for better corrosion resistance
- Cutting hardness: 55 - 65HRC
- 55 - 65HRC
- Hardy design



Code	Length	Inner	Master
TC4244	7"	4	36
TC4245	8"	4	36
TC4246	9"	4	36

Type of packaging: Card

ELECTRICIAN PLIERS, DUAL MATERIAL HANDLE

- Made of #55 carbon steel
- Satin polished finish for better corrosion resistance
- Cutting hardness: 55-65HRC



Code	Length	Inner	Master
TC4247	7"	4	36
TC4248	8"	4	36

Type of packaging: Card

LONG NOSE PLIERS DUAL MATERIAL HANDLES

- Made of #55 carbon steel
- Satin polished finish for better corrosion resistance
- Cutting hardness: 55 - 65HRC
- 55-65HRC



Code	Length	Inner	Master
TC4249	6"	4	36
TC4250	8"	4	36

Type of packaging: Card

DIAGONAL CUTTING PLIERS, DUAL-MATERIAL HANDLE

- Made of #55 carbon steel
- Satin polished finish
- Cutting hardness: 55 - 65HRC



Code	Length	Inner	Master
TC4252	6"	4	36

Type of packaging: Card

6" BENT NOSE PLIERS DUAL MATERIAL HANDLE

- Made of #55 carbon steel
- Satin polished finish for better corrosion resistance
- Hardy design
- Cutting hardness: 55 - 65HRC



Code	Length	Inner	Master
TC4251	6"	4	36

Type of packaging: Card

HIGH LEVERAGE ELECTRICIAN PLIERS

- Made of #55 carbon steel
- Satin polished finish for better corrosion resistance
- Vinyl covered handles
- Cutting hardness: 55 - 65HRC
- 55-65 HRC



Code	Length	Inner	Master
TC4224	9"	3	36

Type of packaging: Card

PROFESSIONAL ELECTRICIAN PLIERS

- Made of #55 carbon steel
- Satin polished finish for better corrosion resistance
- Vinyl covered handles
- Cutting hardness: 55 - 65HRC
- 55-65 HRC
- Hardy design



Code	Length	Inner	Master
TC4225	7"	4	36
TC4226	8"	4	36
TC4227	9"	3	36

Type of packaging: Card

ELECTRICIAN PLIERS

- Made of #55 carbon steel
- Satin polished finish for better corrosion resistance
- Vinyl covered handles
- Cutting hardness: 55 - 65HRC
- 55-65 HRC



Code	Length	Inner	Master
TC4228	6"	4	36
TC4229	7"	4	36
TC4230	8"	4	36

Type of packaging: Card

LONG NOSE PLIERS

- Made of #55 carbon steel
- Satin polished finish for better corrosion resistance
- Vinyl covered handles
- Cutting hardness: 55 - 65HRC
- 55-65 HRC



Code	Length	Inner	Master
TC4231	6"	4	36
TC4232	7"	4	36
TC4233	8"	4	36

Type of packaging: Card

DIAGONAL CUTTING PLIERS

- Made of #55 carbon steel
- Satin polished finish for better corrosion resistance
- Vinyl covered handles
- Cutting hardness: 55 - 65HRC
- 55-65 HRC



Code	Length	Inner	Master
TC4234	5"	4	36
TC4235	6"	4	36
TC4236	7"	4	36

Type of packaging: Card

SLIP JOINT PLIERS

- Made of #45 carbon steel
- Satin polished finish for better corrosion resistance
- Vinyl covered handles
- Cutting hardness: HRC



Code	Length	Inner	Master
TC4238	6"	4	36
TC4239	8"	4	36
TC4240	10"	4	36

Type of packaging: Card

GROOVE JOINT PLIERS

- Made of #45 carbon steel
- Satin polished finish for better corrosion resistance
- Vinyl covered handles
- Five adjustment position
- Jaw hardness
- 40-50 HRC



Code	Length	Inner	Master
TC4241	8"	4	36
TC4242	10"	4	36
TC4243	12"	3	36

Type of packaging: Card

FENCE PLIERS

- Made of #55 carbon steel
- Satin polished finish for better corrosion resistance
- Vinyl covered handles
- Cutting hardness: 55 - 65HRC



Code	Length	Inner	Master
TC4237	11"	3	36

Type of packaging: Card

RETAINING RING PLIERS

- For the automotive industry
- 4 6-1/4 easy interchangeable tips for external and internal rings
- 1 45° tip
- 1 90° tip
- 2 180° tip



Code	Length	Inner	Master
TC0246	6 1/4"	6	36

Type of packaging: Blister

ELECTRONIC CUTTING PLIERS

- Forged in high carbon steel
- Vinyl covered handle
- Hardness: 50 HRC



Code	Size	Inner	Master
TC0335	5"	5	200

Type of packaging: Blister

HEAVY DUTY ELECTRICIAN PLIERS

Wolfox

- Made of carbon steel
- Polished finish
- Vinyl covered handles
- Hardy design

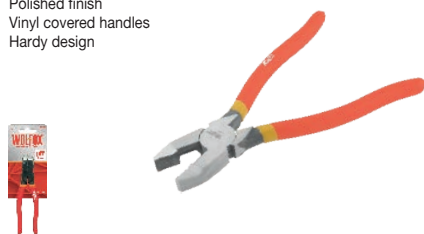

Code	Length	Inner	Master
WF0828	8"	6	48
WF0829	9"	6	48

Type of packaging: Blister

ELECTRICIAN PLIERS

Wolfox

- Made of carbon steel
- Polished finish
- Vinyl covered handles



Code	Length	Inner	Master
WF0857	7"	6	72
*WF0858	8"	6	60

Type of packaging: Blister

LONG NOSE PLIERS

Wolfox

- Made of carbon steel
- Polished finish
- Vinyl covered handles



Code	Length	Inner	Master
*WF0866	6"	6	96
WF0868	8"	6	60

Type of packaging: Blister

DIAGONAL CUTTING PLIERS

Wolfox

- Made of carbon steel
- Polished finish
- Vinyl covered handles



Code	Length	Inner	Master
WF0879	6"	6	96
WF0880	8"	6	60

Type of packaging: Blister

SLIP JOINT PLIERS

Wolfox

- Made of carbon steel
- Polished finish
- Vinyl covered handles



Code	Length	Inner	Master
WF0876	6"	6	96
WF0878	8"	6	60

Type of packaging: Blister

4-PIECE PLIER SET

Wolfox

- Made of carbon steel
- Polished finish
- Vinyl covered handles

- Includes:
- 8" Electrician Pliers
- 6" Long nose pliers
- 6" Diagonal Cutting Pliers
- 8" slip joint pliers



Code	Length	Inner	Master
WF9353	6" and 8"	2	24

Type of packaging: Blister

3-PIECE PLIER SET

Wolfox

- Made of carbon steel
- Polished finish
- Vinyl covered handles

- Includes:
- 6" Long nose pliers
- 6" Diagonal Cutting Pliers
- 6" Electrician Pliers



Code	Length	Inner	Master
WF9352	6"	2	36

Type of packaging: Blister

3-PIECE PLIER SET

Wolfox

- Made of carbon steel
- Polished finish
- Vinyl covered handles (except adjustable wrench)

- Includes:
- 6" slip joint pliers
- 6" adjustable wrench
- 6" Long nose pliers



Code	Length	Inner	Master
WF0610	6"	6	36

Type of packaging: Blister

4-PIECE PLIER SET

Wolfox

- Made of carbon steel
- Polished finish

- Includes:
- Mini 10oz hammer
- 6" slip joint pliers
- #2 x 4" Phillips screwdriver
- 1/4" x 4" slotted screwdriver



Code	Pieces	Inner	Master
WF0611	4	2	24

Type of packaging: Blister

PLIERS

ROUND NOSE MINI PLIERS

Wolfox

- Made of carbon steel
- Vinyl covered handles

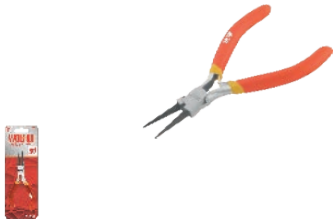

Code	Length	Inner	Master
WF0112	4 3/4"	6	60

Type of packaging: Blister

ELECTRICIAN MINI PLIERS

Wolfox

- Made of carbon steel
- Vinyl covered handles



Code	Length	Inner	Master
WF0110	4 1/2"	6	60

Type of packaging: Blister

LONG NOSE MINI PLIERS

Wolfox

- Forged in carbon steel
- Vinyl covered handles



Code	Length	Inner	Master
WF0106	4 3/4"	6	60

Type of packaging: Blister

LONG NOSE MINI PLIERS

Wolfox

- Made of carbon steel
- Vinyl covered handles



Code	Length	Inner	Master
WF0107	4 5/16"	6	60

Type of packaging: Blister

NEEDLE NOSE MINI PLIERS

Wolfox

- Made of carbon steel
- Vinyl covered handles

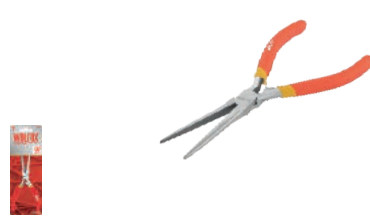

Code	Length	Inner	Master
WF0109	5 7/8"	6	60

Type of packaging: Blister

8" AUTOMATIC WIRE STRIPPER

Wolfox

- Made of carbon steel
- Black phosphate coat
- For cutting and crimping
- Cutting capacity: 0,26,0 - 0,2 mm
- Crimping caliper: 1.5 - 6 mm



⚠ Do not use for cutting steel cable

Code	Length	Inner	Master
TC4620	8"	3	48

Type of packaging: Card

9" WIRE STRIPPER

- Made of carbon steel
- Black phosphate coat
- For cutting and crimping
- Cutting capacity: 10, 12, 14, 16, 18, 20 and 22
- Crimping caliper: 14-22,10-22,10-12



⚠ Do not use for cutting steel cable

Code	Length	Inner	Master
TC4617	9"	6	48

Type of packaging: Card

8" WIRE STRIPPER

- Made of carbon steel
- Black phosphate coat
- For cutting and crimping
- Cutting capacity: 10, 12, 14, 16, 18, 20 and 22 AWG
- Crimping caliper: 10-16, 18-22



Code	Length	Inner	Master
TC4618	8"	6	48

Type of packaging: Card

6" WIRE STRIPPER

- Made of carbon steel
- Black phosphate coat
- For cutting
- Cutting capacity: 0,6, 0,8, 1,0, 1,3, 1,6, 2,0 and 2,6 mm



Code	Length	Inner	Master
TC4619	6"	6	120

Type of packaging: Card

6" PRECISION AUTOMATIC WIRE STRIPPER

- Made of zinc alloy
- Black phosphate coat
- For cutting
- Cutting capacity: 1 - 3,2 mm



⚠ Do not use for cutting steel cable

Code	Length	Inner	Master
TC4621	6"	3	48

Type of packaging: Card

7" AUTOMATIC WIRE STRIPPER

Wolfox

- Made of carbon steel
- Vinyl covered handles
- For cutting
- Cutting capacity: 0,5 - 6 mm



Code	Length	Inner	Master
WF0603	7"	6	48

Type of packaging: Blister

9 1/2" WIRE STRIPPER

Wolfox

- Made of low carbon steel
- For cutting
- Cutting capacity: 10,12,14,16,18, 20 and 22 AWG



Code	Length	Inner	Master
WF0083	9 1/2"	6	48

Type of packaging: Blister

CURVED JAW LOOKING PLIERS

- Made of chrome vanadium steel
- Chrome plated finish



Allen Hex Key inlet

Code	Length	Inner	Master
TC0129	7"	3	36
TC0130	10"	3	36
TC4144	12"	3	24

Type of packaging: Card

STRAIGHT JAW LOOKING PLIERS

- Made of chrome vanadium steel
- Chrome plated finish



Allen Hex Key inlet

Code	Length	Inner	Master
TC0127	7"	3	36
TC0128	10"	3	36
TC4143	12"	3	24

Type of packaging: Card

C-CLAMP LOOKING PLIERS, SWIVEL TIP

- Made of chrome vanadium steel
- Chrome plated finish
- Special for work on irregular surfaces



Allen Hex Key inlet

Code	Length	Inner	Master
TC4164	6"	3	30
TC0251	11"	3	30

Type of packaging: Card

C-CLAMP LOOKING PLIERS, STANDARD TIP

- Made of chrome vanadium steel
- Chrome plated finish
- For sheet metal work where pressure needs to be applied on hard to reach areas.
- Carbon steel clamps



Allen Hex Key inlet

Code	Length	Inner	Master
TC0250	11"	3	30

Type of packaging: Card

LONG NOSE LOOKING PLIERS

- Made of chrome vanadium steel
- Chrome plated finish



Allen Hex Key inlet

Code	Length	Inner	Master
TC4145	6"	3	36
TC4146	9"	3	36

Type of packaging: Card

CLAMP WELDING LOOKING PLIERS

- Made of carbon steel
- Chrome plated finish
- For welding beams, "T" profiles, bars, tubes, etc.



Allen Hex Key inlet

Code	Length	Inner	Master
TC0249	9"	3	30

Type of packaging: Card

SHEET METAL LOOKING PLIERS

- Made of carbon steel
- Chrome plated finish
- For sheet metal works, sheet and pipe welding



Allen Hex Key inlet

Code	Length	Inner	Master
TC0248	8"	3	30

Type of packaging: Card

CHAIN LOOKING PLIERS

- Made of carbon steel
- Chrome plated finish



Allen Hex Key inlet

Code	Chain length	Inner	Master
TC4147	50 cm	3	30

Type of packaging: Card

CURVED JAW LOOKING PLIERS

- Made of carbon steel
- Chrome plated finish



Code	Length	Inner	Master
WF0118	7"	6	48
WF0119	10"	6	48

Type of packaging: Blister

Wolfbox

STRAIGHT JAW LOOKING PLIERS

- Made of carbon steel
- Chrome plated finish



Code	Length	Inner	Master
WF0890	7"	6	48
*WF0891	10"	6	48

Type of packaging: Blister

Wolfbox

RIVETERS

FOLDING RIVETER

- Steel accordion
- Nozzles included: 1/8", 3/32", 5/32", 3/16" and 1/4"
- Wrench included



Code	Length	Maximum Riveting Thickness	Inner	Master
TC0207	32"	1/4"	2	12

Type of packaging: Box

ALUMINUM PROFESSIONAL RIVETER

- Made of aluminum
- Nozzles included: 1/8", 3/32", 5/32", 3/16"
- Wrench included



Code	Length	Maximum Riveting Thickness	Inner	Master
TC0315	10"	3/16"	4	24

Type of packaging: Blister

PROFESSIONAL RIVETER SET WITH 60 RIVETS

- Forged steel body and handle
- Nozzles included: 1/8", 3/32", 5/32", 3/16"
- Wrench included



Code	Length	Maximum Riveting Thickness	Inner	Master
TC0126	10"	3/16"	4	24

Type of packaging: Blister

PROFESSIONAL RIVETER

- Forged steel body and handle
- Nozzles included: 1/8", 3/32", 5/32", 3/16"
- Wrench included



Code	Length	Maximum Riveting Thickness	Inner	Master
TC0007	10"	3/16"	6	24

Type of packaging: Blister

RIVETER WITH 40 RIVETS

- Forged steel body and handle
- Nozzles included: 1/8", 3/32", 5/32", 3/16"
- Wrench included

Wolfox



Code	Length	Maximum Riveting Thickness	Inner	Master
WF0617	9 1/2"	"	6	24

Type of packaging: Blister

RIVET

- Made of aluminum AL5050
- Steel head



**Bag
50 pieces**
*Price per bag

Code	Model	Diameter / Grip	Rivet head	Inner	Master
TC5001	AS41	1/8" x 1/16"	1/4"	20	400
TC5002	AS42	1/8" x 1/8"	1/4"	20	400
TC5003	AS43	1/8" x 1/8"	1/4"	20	400
TC5004	AS44	1/8" x 1/8"	1/4"	20	400
TC5005	AS45	1/8" x 1/8"	1/4"	20	400
TC5006	AS46	1/8" x 1/8"	1/4"	20	400
TC5007	AS48	1/8" x 1/8"	1/4"	10	200
TC5008	AS52	5/32" x 5/32"	5/16"	10	200
TC5009	AS54	5/32" x 5/32"	5/16"	10	200
TC5010	AS56	5/32" x 5/32"	5/16"	10	200
TC5011	AS58	5/32" x 5/32"	5/16"	10	200
TC5012	AS610	3/16" x 3/16"	3/8"	5	100
TC5013	AS610LF	3/16" x 3/16"	17/32"	5	100
TC5014	AS612	3/16" x 3/16"	3/8"	5	100
TC5015	AS612LF	3/16" x 3/16"	17/32"	5	100
TC5016	AS62	3/16" x 3/16"	3/8"	10	200
TC5017	AS64	3/16" x 3/16"	3/8"	10	200
TC5018	AS64LF	3/16" x 3/16"	17/32"	5	100
TC5019	AS66	3/16" x 3/16"	3/8"	10	100
TC5020	AS66LF	3/16" x 3/16"	17/32"	5	100
TC5021	AS68	3/16" x 3/16"	3/8"	10	100
TC5022	AS68LF	3/16" x 3/16"	17/32"	5	100
TC5023	AS84	1/4" x 1/4"	1/2"	5	50
TC5024	AS86	1/4" x 1/4"	1/2"	5	50
TC5025	AS88	1/4" x 1/4"	1/2"	5	50

Type of packaging: Bag

RIVETER

- Forged steel body and handle
- Nozzles included: 1/8", 3/32", 5/32", 3/16"
- Wrench included

Wolfox



Code	Length	Maximum Riveting Thickness	Inner	Master
WF6601	9 1/2"	"	6	24

Type of packaging: Blister

HACKSAW BLADES

BI-METAL HACKSAW BLADE

- Made of tempered steel
- Long life
- High flexibility
- Available in 18 dpp and 24 dpp



Code	DPP	Inner	Master
TC1977	18	50	500
TC1979	24	50	500

Type of packaging: Bulk

BI-METAL HACKSAW BLADE, 2-PIECE BLISTER

- Made of tempered steel
- High flexibility
- Available in 18 dpp and 24 dpp



Code	DPP	Inner	Master
TC1978	18	20	120
TC1980	24	20	120

Type of packaging: Blister 2 pcs

CARBON STEEL T-SHANK JIGSAW BLADES, 5 PIECES

- Made of HCS steel
- Straight wood and PVC cutting

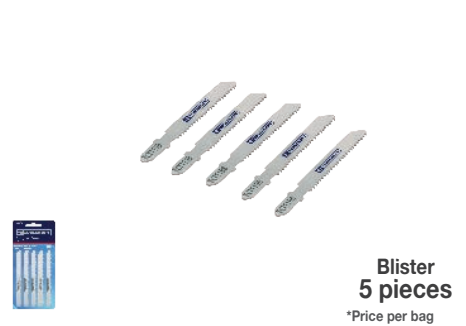

Code	Characteristics	Length	Finish	DPP	Inner	Master
TC2339	TCT101B	4"	Fine	10	10	100
TC2340	TCT101BR	4"	Fine	10	10	100
TC2345	TCT119B	3"	Fine	12	10	100
TC2342	TCT111C	4"	Standard	8	10	100
TC2341	TCT101D	4"	Thick	6	10	100

Type of packaging: Blister

HSS HIGH SPEED U-SHANK JIGSAW BLADES, 5 PIECES

- Made of HSS steel
- Straight metal, plastic and aluminum cutting



Code	Characteristics	Length	Finish	DPP	Inner	Master
TC2353	TCU118A	2 3/4"	Super fine	24	10	100
TC2354	TCU118B	3"	Fine	12	10	100

Type of packaging: Blister

HSS HIGH SPEED T-SHANK JIGSAW BLADES, 5 PIECES

- Made of HSS steel
- Straight metal, plastic and aluminum cutting



Code	Characteristics	Length	Finish	DPP	Inner	Master
TC2343	TCT118A	3"	Super fine	21	10	100
TC2344	TCT118AF	3 1/2"	Thick	18	10	100
TC2347	TCT127D	4"	Fine	8	10	100

Type of packaging: Blister

CARBON STEEL U-SHANK JIGSAW BLADE, 5 PIECES

- Made of HCS steel
- Straight cutting in wood

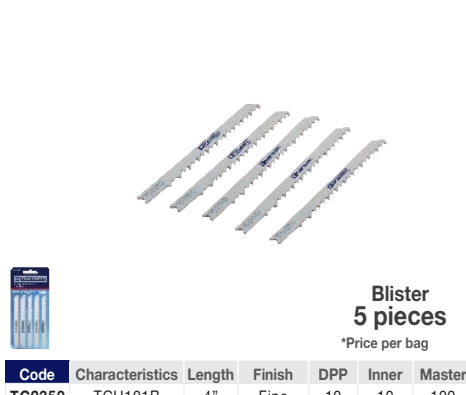

Code	Characteristics	Length	Finish	DPP	Inner	Master
TC2350	TCU101B	4"	Fine	10	10	100
TC2351	TCU101D	4"	Standard	6	10	100
TC2352	TCU111C	3 1/2"	Thick	8	10	100
TC2355	TCU144D	4"	Thick	6	10	100

Type of packaging: Blister

CARBON STEEL T-SHANK JIGSAW BLADES, 5 PIECES

- Made of HCS steel
- Curved wood cutting

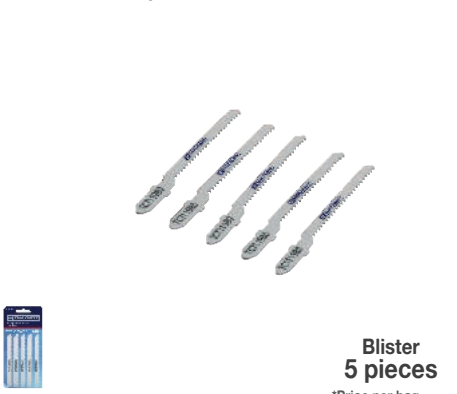

Code	Characteristics	Length	Finish	DPP	Inner	Master
TC2346	TCT119B	3"	Fine	12	10	100
TC2348	TCT244D	4"	Thick	6	10	100

Type of packaging: Blister

CARBON STEEL U-SHANK JIGSAW BLADE, 5 PIECES

- Made of HCS steel
- Curved wood cutting



Code	Characteristics	Length	Finish	DPP	Inner	Master
TC2349	TCU119B	2 3/4"	Fine	14	10	100

Type of packaging: Blister

HACKSAW BLADES

- Made of HCS steel
- 10 - 14 tooth per inch
- For metal, wood, and plastic cutting
- Input: M42+D64



Code	Width	Length	Inner	Master
TC4549	19 mm	6"	5	100
TC4550	19 mm	9"	5	100
TC4551	19 mm	12"	5	100

Type of packaging: Blister



SAFETY

5 RINGS FALL PROTECTION RESCUE HARNESS

- Forged steel "D" ring
- 100% polyester strip
- It has 2 lateral "D" rings" and 3 mobiles "D" rings in the back for correct height adjustment
- Especial against falls, rescue and positioning

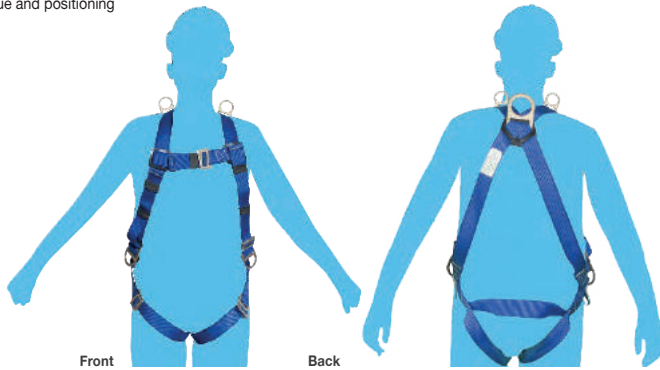

3 RINGS FALL PROTECTION RESCUE HARNESS

- Forged steel "D" rings
- 100% polyester strip
- It has 2 lateral "D" rings" and 1 "D" ring in the back
- Special against falls and rescue

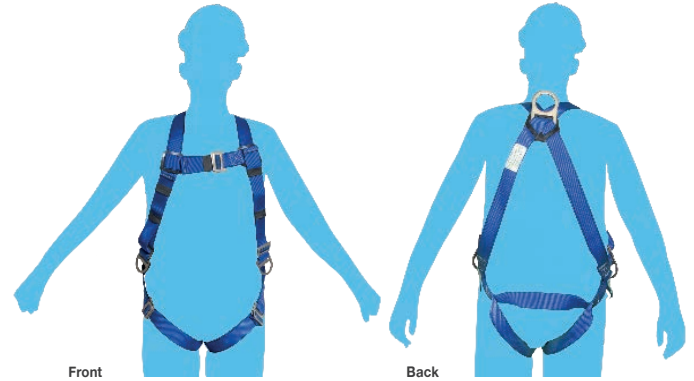

Code	Size	Load capacity	Tensile Strength	Inner	Master
TC5292	40 - 44	150 kg	2,300 kg	1	12

Type of packaging: Blister

Code	Size	Load capacity	Tensile Strength	Inner	Master
TC5291	40 - 44	150 kg	2,300 kg	1	12

Type of packaging: Blister

POSITIONING HARNESS

- Forged steel "D" ring
- 100% polyester strip
- It has 2 lateral "D" rings
- Special for working at heights

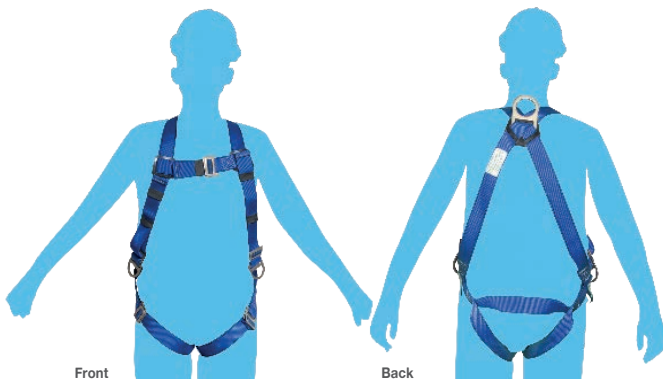

FALL PROTECTION SAFETY HARNESS

- Forged steel "D" Ring
- 100% polyester strip
- It has 1 "D" ring in the back
- Special for working at heights

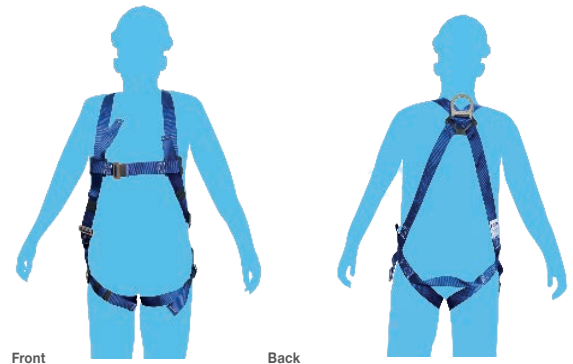

Code	Size	Load capacity	Tensile Strength	Inner	Master
TC2654	40 - 44	150 kg	2,300 kg	1	12

Type of packaging: Blister

Code	Size	Load capacity	Tensile Strength	Inner	Master
TC2656	40 - 44	150 kg	2,300 kg	1	12

Type of packaging: Blister

SHOCK ABSORBING SAFETY CABLE

- Braided polyester body
- Forged steel ring



Code	Length	Tensile Strength	Inner	Master
TC2728	1.80 m	2,300 kg	1	6

Type of packaging: Bag

SAFETY CABLE WITH ANCHOR

- Braided polyester body
- Forged steel ring



Code	Length	Tensile Strength	Inner	Master
TC2727	1.80 m	2,300 kg	1	6

Type of packaging: Bag

ANCHOR

- Polyester body
- Fall protection system ring
- With: 4.5 cm



Code	Length	Tensile Strength	Inner	Master
TC2651	90 cm	2,300 kg	6	12

Type of packaging: Bag

INDUSTRIAL RUBBER BOOTS

- Made with PVC injection
- Nylon - polyester inner lining
- Abrasion, bending and tear resistant material
- Resistant to gas, oil and corrosive dilute acids (sulfuric acid, acetic acid, nitric acid, etc.) solvents, greases, detergents, mud, sludge, steam, etc.
- Reinforced shark and toe cap
- Slip-resistant out sole and heel cushion



Code	Size MX	Size USA	Total height	Inner	Master
TC5155	24	6	38 cm	2	12
TC5156	25	7	39 cm	2	12
TC5157	26	8	39 cm	2	12
TC5158	27	9	40 cm	2	12
TC5159	28	10	41 cm	2	12
TC5160	29	11	41 cm	2	12
TC5161	30	12	42 cm	2	12

Type of packaging: Bag

WHITE RUBBER BOOTS

- Made with PVC injection
- Nylon - polyester inner lining
- Abrasion, bending and tear resistant material
- Resistant to water, detergent, acids, corrosives, grease, mud, sludge, steam, etc.
- Reinforced shark and toe cap
- Slip resistant out sole and shoe removal in heel.



Code	Size MX	Size USA	Total height	Inner	Master
TC5169	24	6	33 cm	2	12
TC5170	25	7	34 cm	2	12
TC5171	26	8	34 cm	2	12
TC5172	27	9	35 cm	2	12
TC5173	28	10	36 cm	2	12
TC5174	29	11	36 cm	2	12
TC5175	30	12	37 cm	2	12

Type of packaging: Bag

GARDENING RUBBER BOOTS

- Made with PVC injection
- Nylon - polyester inner lining
- Abrasion, bending and tear resistant material
- Resistant to water, detergent, mud, sludge, steam, etc.
- Reinforced shark and toe cap
- Slip resistant out sole and shoe removal in heel.



Code	Size MX	Size USA	Total height	Inner	Master
TC5162	24	6	33 cm	2	12
TC5163	25	7	34 cm	2	12
TC5164	26	8	34 cm	2	12
TC5165	27	9	35 cm	2	12
TC5166	28	10	36 cm	2	12
TC5167	29	11	36 cm	2	12
TC5168	30	12	37 cm	2	12

Type of packaging: Bag

LEATHER STEEL TOE WORKBOOTS

- Made of 100% leather
- Steel toe with memory
- 6 grommets
- Anti-slip sole
- Latex with cotton sole



Code	Size MEX	Size USA	Inner	Master
TC2767	25	7	2	4
TC2768	25 1/2	7 1/2	2	4
TC2769	26	8	2	4
TC2770	26 1/2	8 1/2	2	4
TC2771	27	9	2	4
TC2772	27 1/2	9 1/2	2	4
TC2773	28	10	2	4
TC2774	28 1/2	10 1/2	2	4
TC2775	29	11	2	4
TC2776	29 1/2	11 1/2	2	4
TC2777	30	12	2	4

Type of packaging: Box

SAFETY VEST WITH DOUBLE HIGH VISIBILITY STRIPS

- Made of polyester
- Knitted on front and mesh fabric on back
- Strip width: 5cm
- For day and night use



Code	Color	Inner	Master
TC4302	Orange	5	50
TC4303	Yellow	5	50

Type of packaging: Bag

SAFETY VEST WITH HIGH VISIBILITY STRIP

- Made of polyester
- Knitted on front and mesh fabric on back
- Strip width: 5cm
- For day and night use

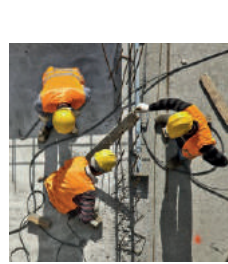

Code	Color	Inner	Master
TC4300	Orange	5	50
TC4301	Yellow	5	50

Type of packaging: Bag

SAFETY VEST WITH REFLECTIVE STRIPS

- Made of polyester
- Strip width: 5cm
- For day use

Wolfox

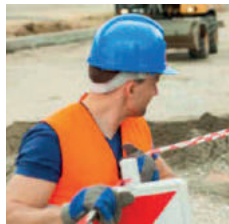

SAFETY VEST

- Made of polyester
- For day use

Wolfox

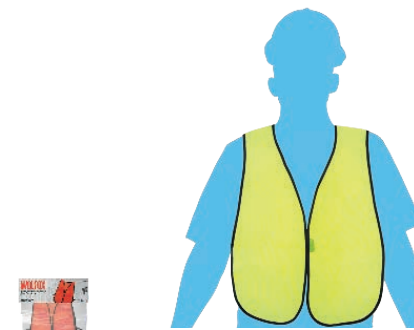

Code	Color	Inner	Master
WF0285	Orange	5	50
WF0286	Yellow	5	50

Type of packaging: Bag

Code	Color	Inner	Master
WF0283	Orange	5	50
WF0284	Yellow	5	50

Type of packaging: Bag

SAFETY HELMET

- Padded sweatband for Customized height and fit
- Adjustment of 6 1/2" a 7 3/4"
- Made of high impact polypropylene



* This product exceeds the Standards **ANSI**

* This product has certification



Code	Color	Inner	Master
TC0575	Yellow	10	50
TC0576	Blue	10	50
*TC0577	Orange	10	50
*TC0795	White	10	50
TC0796	Red	10	50
TC0797	Green	10	50

Type of packaging: Bulk

ROAD WARNING POST 1.15 M

- Made of ABS and PVC base
- Impact resistant
- Octagonal base
- Total weight: 7 kg



*It is delivered in 2 bags

Code	Base (diameter)	Height	Reflective width	Inner	Master
TC5259	40 cm	1.15 m	25 cm	4	4

Type of packaging: Bulk

SAFETY CONE

- Made of PVC
- Impact resistant
- Non-deformable
- With reflective belt



Code	Base	Height	Reflection belt with	Inner	Master
TC3999	28 x 28 cm	45 cm	10 cm	1	5
TC4000	36 x 36 cm	70 cm	25 cm	1	5
TC4001	36 x 36 cm	90 cm	10 y 15 cm	1	5

Type of packaging: Bulk

45 CM FOLDABLE CONE

- Made of waterproof fabric
- Impact resistant
- With 2 reflective belts
- Polypropylene base



Code	Base	Height	Reflective width	Inner	Master
TC5258	24 x 24 cm	45 cm	3.5 cm	1	20

Type of packaging: Box

LIGHT SAFETY CONE 48 CM

- Made of PVC
- Impact resistant
- Non-deformable



Code	Base	Height	Inner	Master
WF9349	38 x 38 cm	68 cm	1	5

Type of packaging: Bulk



GUARDIAN SAFETY BARRIER FENCE

- Made of polyethylene
- 110 mm x 30 mm opening
- Tension resistance: 17 kgf
- Weight per linear meter: 120 g
- Roll weight: 3.6 kg (8lbs)

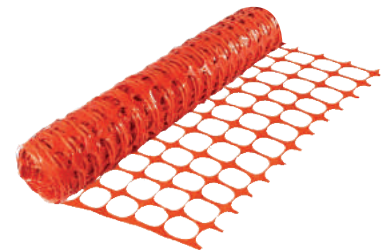

Code	Size	Inner	Master
TC2855	1.20 m x 30.5 m	1	1

Type of packaging: Roll



TAPES

PLASTIC CHAINS

- Made of high density polyethylene
- 25 m reel



Wolfox

NON-SLIP TAPE

- Made of polyurethane with 0.75 mm thickness
- Acrylic adhesive of great sensitivity to pressure
- Weather resistant
- High friction texture
- Special for steps and bath tubs



Code	Color	Thickness	Inner	Master
WF9354	White	1/4"	2	2
WF9355	Yellow	1/4"	2	2
WF9356	Orange	1/4"	2	2
WF9357	Black	1/4"	2	2
WF9358	White	5/16"	2	2
WF9359	Yellow	5/16"	2	2
WF9360	Orange	5/16"	2	2
WF9361	Black	5/16"	2	2

Type of packaging: Cardboard reel



Code	Size	Color	Inner	Master
TC5102	25 mm x 5 m	Black	6	72
TC1077	50 mm x 5 m	Black	6	72
TC5269	50 mm x 5 m	Clear	6	72
TC5270	50 mm x 5 m	Black / Yellow	6	72

Type of packaging: Box

SELF STICK SAFETY STRIPE TAPE

- Made of polyethylene
- Thickness: 0.130 mm
- Length: 30 m
- Acrylic adhesive



Code	Color	Inner	Master
TC5098	Yellow / black	6	36
TC5099	Red / white	6	36

Type of packaging: Bulk

BARRICADE TAPE

- Made of polyethylene 3" wide
- Thickness: 0.04 mm
- Length: 1000' / 300 m
- Great resistance

Printed in Spanish and English



Code	Characteristics	Inner	Master
TC0994	"Precaución" / "Caution"	6	12
TC0995	"Peligro" / "Danger"	6	12
TC0996	"Prohibido el paso" / "No trespassing"	6	12

Type of packaging: Roll

BARRICADE TAPE

- Made of 3" width polyethylene
- Thickness: 0.03mm
- Length: 300' / 90 m

Wolfox



Code	Characteristics	Inner	Master
WF0725	"Precaución" / "Caution"	6	36

Type of packaging: Bulk

ELECTRONIC HELMET FOR WELDING

- Made of polypropylene
- Polycarbonate lens
- The lens darkens automatically
- Protection in ARC, MIG, MAG and TIG welding
- UV / IR protection: up to shade DIN 13
- Power supply: photocell and battery
- Safety test button
- Battery life (interchangeable): 2,000 hrs



Printed in Spanish and English Code	Color	Model	Shadow	Inner	Master
TC3874	Black	Electronic	H-300	1	6
TC5306	Grey / Blue	Electronic	H-300	1	6
TC5307	Flames	Electronic	H-300	1	6
Spare parts					
TC5372		Front / back lenses		10	640

Type of packaging: Box (Masks), bag (TC3872)

WELDING HELMET

- Made of high impact polypropylene
- Fold-up window
- Adjustable plastic head band
- Includes: shade and lens



Code	Model	Inner	Master
TC0581	Traditional	6	6
Spare parts			
TC1055	Shade 11	100	500
TC1056	Shade 12	100	500
TC1060	Clear	100	500

Type of packaging: Bag

ELECTRONIC HELMET FOR WELDING

- Made of polypropylene
- Polycarbonate lens
- The lens darkens automatically
- Welding protection for ARC, MIG, MAG and TIG
- UV / IR protection: up to shade DIN 13
- Source power: photocell and battery
- Safety test button
- Battery life (not interchangeable): 1,000 hrs



Code	Model	Shadow	Inner	Master
WF0714	Electronic	H-100	1	6
Spare parts				
WF0727		Front / back lenses	10	720

Type of packaging: Box (WF0714), bag (WF0727)



WELDING HELMET

- Made of polypropylene
- Fold-up window
- Includes shade
- Adjustable plastic head band



Code	Model	Inner	Master
WF9639	Traditional	6	2
4 Spare parts			
TC1055	Shade 11	100	500
TC1056	Shade 12	100	500
TC1060	Clear	100	500

Type of packaging: Bag



RIGID KNEE PAD

- PVC covered
- Breathable lining
- Elastic strap



Code	Characteristics	Inner	Master
TC1813	Rigid	2	40

Type of packaging: Bag

FLEXIBLE KNEE PAD

- Made of foam rubber
- Flat surface
- Elastic strap

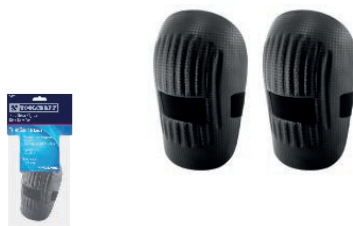

Code	Characteristics	Inner	Master
TC1814	Flexible	2	40

Type of packaging: Bag

ADJUSTABLE EAR MUFFS

- 25dB (SNR), 17dB(SNR) noise reduction rating



Code	Characteristics	Inner	Master
TC1807	Adjustable	3	60

Type of packaging: Bag

CORDED EAR PLUGS

- Made of soft rubber
- 25dB noise reduction rating
- Case included



Code	Characteristics	Inner	Master
TC0574	Corded	50	1000

Type of packaging: Plastic case

REUSABLE EAR PLUG CORDED

- Made of polyurethane
- 37dB (SNR) noise reduction rating
- 32 dB (NRR)



Code	Characteristics	Inner	Master
TC1806	Reusable	50	2000

Type of packaging: Bag

REUSABLE CORDED EAR PLUG

- Made of polyurethane
- 37dB (SNR), 32dB (SNR) noise reduction rating



Code	Characteristics	Inner	Master
TC1805	Reusable	100	2000

Type of packaging: Bag

SAFETY | GLASSES

FACTORY SAFETY SUPPORT GLASSES

- Anti-scratch polycarbonate lens
- Sport and comfort design
- Light weight for prolonged use



* This product exceeds the Standards **ANSI**

Code	Color	Inner	Master
TC4264	Transparent <input type="checkbox"/>	12	300
*TC4265	Grey <input type="checkbox"/>	12	300
TC4266	Yellow <input type="checkbox"/>	6	300
TC4267	Green <input type="checkbox"/>	12	300
TC4268	Blue <input type="checkbox"/>	12	300
TC4269	Silver mirror <input type="checkbox"/>	12	300
TC4270	Blue Mirror <input type="checkbox"/>	12	300

Type of packaging: Bag

FREEDOM SAFETY SPORT GLASSES

- Anti-scratch polycarbonate lens
- Peripheral vision design
- Adjustable arms



* This product exceeds the Standards **ANSI**

Code	Color	Inner	Master
TC4273	Transparent <input type="checkbox"/>	12	300
TC4274	Grey <input type="checkbox"/>	12	300

Type of packaging: Bag

NUVO SAFETY GLASSES

- Polycarbonate lens
- Adjustable arms



* This product exceeds the Standards **ANSI**

Code	Color	Inner	Master
TC1798	Clear <input type="checkbox"/>	12	300
TC1799	Smoke <input type="checkbox"/>	12	300
TC1800	Amber <input type="checkbox"/>	12	300

Type of packaging: Bag

FUEL SAFETY SPORT GLASSES

- Anti-scratch polycarbonate lens
- Sport and comfortable design
- Light weight for prolonged use



* This product exceeds the Standards **ANSI**

Code	Color	Inner	Master
TC4271	Clear <input type="checkbox"/>	12	300
*TC4272	Grey <input type="checkbox"/>	12	30

Type of packaging: Bag

NEO SAFETY GLASSES

- Polycarbonate lens
- Light design



* This product exceeds the Standards **ANSI**

Code	Color	Inner	Master
*TC1801	Clear <input type="checkbox"/>	12	300
*TC1802	Smoke <input type="checkbox"/>	12	300
TC1803	Amber <input type="checkbox"/>	12	300

Type of packaging: Bag

SUPERVISOR SAFETY GLASSES TRICOLOR FRAME

- Polycarbonate lens
- Adjustable arms



* This product exceeds the Standards **ANSI**

Code	Color	Inner	Master
*TC0567	Clear <input type="checkbox"/>	12	300
TC0568	Smoke <input type="checkbox"/>	12	300

Type of packaging: Bag

SUPERVISOR SAFETY GLASSES MARCO NEGRO

- Polycarbonate lens
- Adjustable arms



* This product exceeds the Standards **ANSI**

Code	Color	Inner	Master
TC0569	Clear <input type="checkbox"/>	12	300
*TC0570	Smoke <input type="checkbox"/>	12	300

Type of packaging: Bag

SUPERVISOR SAFETY GLASSES YELLOW FRAME

- Polycarbonate lens
- Adjustable arms



* This product exceeds the Standards **ANSI**

Code	Color	Inner	Master
TC1918	Yellow <input type="checkbox"/>	12	300

Type of packaging: Bag

VISITOR SAFETY GLASSES

- Polycarbonate lens
- Anti-fog slots



* This product exceeds the Standards **ANSI**

Code	Color	Inner	Master
*TC0791	Clear <input type="checkbox"/>	12	300
TC0572	Smoke <input type="checkbox"/>	12	300
TC0571	Amber <input type="checkbox"/>	12	300

Type of packaging: Bag

GLASSES

- Polycarbonate lens
- Light model

Wolfcraft



* This product exceeds the Standards **ANSI**

Code	Color	Inner	Master
*WF9644	Smoke <input type="checkbox"/>	12	300
WF9643	Clear <input type="checkbox"/>	12	300

Type of packaging: Bag

ADJUSTABLE FACE SHIELD

- Lens made of polycarbonate
- PVC headgear with upper protector
- Adjustable belt



* This product exceeds the Standards **ANSI**

Code	Characteristics	Inner	Master
TC0794	Transparent lens	6	24

Type of packaging: Bag

FACE SHIELD

- Lens made of polycarbonate
- Adjustable belt



Code	Characteristics	Inner	Master
TC0872	Transparent lens	10	60

Type of packaging: Bag

FLIP-UP WELDING GOGGLES

- Frame made of ABS
- Polycarbonate lens
- Ventilation valve



Code	Shadow	Inner	Master
TC0793	#5	4	60

Type of packaging: Bag

FLIP-UP WELDING GOGGLES

- Frame made of ABS
- Polycarbonate lens
- Ventilation valve



Code	Shadow	Inner	Master
TC0873	#5	4	120

Type of packaging: Bag

* This product exceeds the Standards ANSI

**CLEAR SAFETY GOGGLES
INDIRECT VENTILATION**

- Frame made of PVC
- Polycarbonate lens



Code	Ventilation	Inner	Master
TC1804	Indirect	10	100

Type of packaging: Bag

**CLEAR SAFETY GOGGLES
DIRECT VENTILATION**

- Frame made of PVC
- Polycarbonate lens
- With small holes to prevent the lenses from fogging up



Code	Ventilation	Inner	Master
TC0573	Direct	10	100

Type of packaging: Bag

* This product exceeds the Standards ANSI

**SAFETY GOGGLES
TRANSPARENT DIRECT
VENTILATION**



- Made polypropylene
- With small holes to prevent the lenses from fogging up

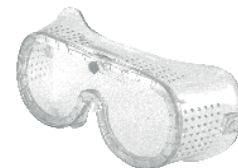

Code	Ventilation	Inner	Master
WF9636	Direct	15	150

Type of packaging: Bag

* This product exceeds the Standards ANSI

RESPIRATOR, 2 FILTERS

- Double respirator for interchangeable cartridges
- Adjustable elastic belts
- Cartridge not included



Code	Characteristics	Inner	Master
TC1809	2 filters	6	36
Spare parts			
TC1810	For dust	10	200
TC1811	For organic steam	10	200
TC1812	For spray paint	10	200

Type of packaging: Bag

RESPIRATOR, 1 FILTER

- Respirator for interchangeable cartridges
- Adjustable elastic belts
- Cartridge not included



Code	Characteristics	Inner	Master
TC1808	1 filter	6	3
6 Spare parts			
TC1810	For dust	10	200
TC1811	For organic steam	10	200
TC1812	For spray paint	10	200

Type of packaging: Bag

DUST MASK

- Recommended for dust, alfalfa, pollen and non-toxic paint
- Elastic band for custom fit
- Metal nose clip for a better fit



Code	Characteristics	Inner	Master
TC0792	Dust mask	4	20

Type of packaging: Box

Box
50 pieces
Price per box

LAMBSKIN LEATHER GLOVES

- Elastic on wrist for better fit
- For handling construction, gardening and farming materials



Code	Size	Inner	Master
TC1685	One size fits all	3	48

Type of packaging: Card

COWHIDE LEATHER GLOVES

- Elastic on wrist for better fit
- For handling construction, gardening and farming materials



Code	Size	Inner	Master
TC1686	One size fits all	3	48

Type of packaging: Card

GOATSKIN LEATHER GLOVES

- Made of: Goat skin: 50%
Leather 50%
- For construction work, driving, household work, hand tools, livestock industry, etc.



Code	Size	Inner	Master
TC4179	One size fits all	3	48

Type of packaging: Card

LEATHER WELDER GLOVES

- Heavy-duty leather
- Cotton inner lining
- Long cuff



Code	Size	Inner	Master
TC3405	One size fits all	3	36

Type of packaging: Card

LEATHER GLOVES

- Cotton inner lining
- Reinforced palm
- General use and material handling



Code	Size	Cuff	Inner	Master
TC1689	One size fits all	Short	6	48
TC0757	One size fits all	Length	3	72

Type of packaging: Card

CANVAS AND FABRIC GLOVES, REINFORCED

- Soft inner lining
- Reinforced fingertips and knuckle
- General use, material handling



Code	Size	Inner	Master
TC0754	One size fits all	6	72

Type of packaging: Card

CANVAS AND LEATHER GLOVES

- Soft inner lining
- Reinforced palm, one single piece
- General use and material handling



Code	Size	Inner	Master
TC2646	One size fits all	6	120
WF9446	One size fits all	6	120

Type of packaging: Card

CANVAS AND LEATHER GLOVES WITH STRIPES

- Soft inner lining
- Elastic on wrist for better fit
- For gardening



Code	Size	Inner	Master
TC0830	One size fits all	6	120

Type of packaging: Card

MECHANIC GLOVES

- Made of cotton
- Adjustable with velcro
- Synthetic leather covered palm and fingers



Code	Size	Inner	Master
TC1688	One size fits all	3	48

Type of packaging: Card

ANTI-SLIP GLOVES

- Elastic on wrist for better fit
- Canvas Fabric on the back
- PVC points on the palm for better grip
- For gardening



Code	Size	Inner	Master
TC0623	One size fits all	6	60

Type of packaging: Card

JERSEY GLOVES

- Elastic on wrist for better fit
- Made of cotton and polyester
- For manual tool handling



Code	Size	Inner	Master
TC1690	One size fits all	6	48

Type of packaging: Card

CANVAS GLOVES

- Elastic on wrist for better fit
- For gardening



Code	Size	Inner	Master
TC1082	One size fits all	6	288

Type of packaging: Card

**ANTI-SLIP GLOVES
PALM AND BACK**

- **Toolcraft Glove** covered in PVC dots on palm and back
- **Wolfox Glove** covered in PVC dots on palm
- Ideal for handling slippery materials



Code	Size	Inner	Master
TC1687	One size fits all	6	48
WF9638	One size fits all	12	300

Type of packaging: Card

**RUBBER-COATED
COTTON GLOVES**

- For construction use
- Cut resistant



Code	Size	Inner	Master
TC4182	One size fits all	6	120

Type of packaging: Card

**RUBBER-COATED
COTTON GLOVES**

- Rough anti-skid finish
- For construction and manual tool handling



Code	Size	Inner	Master
TC1437	Medium	6	120
TC1438	Large	6	120

Type of packaging: Card

**NITRILE-COATED ELASTIC NYLON
GLOVES**

- Maximum sensibility
- Cut resistant
- For construction, manual and mechanical tool handling



Code	Size	Inner	Master
TC4287	Medium	6	120
TC4288	Large	6	12

0 Type of packaging: Card

**POLYURETHANE-COATED
ELASTIC NYLON GLOVES**

- Maximum sensibility for fragile manipulation
- Abrasion resistant
- For mechanical work
- For construction or electric tool handling among others.



Code	Size	Inner	Master
TC4285	Medium	6	120
TC4286	Large	6	120

Type of packaging: Card

**NITRILE-COATED
COTTON GLOVES**

- Resistant to cuts and abrasion
- For oily and wet environments
- For material handling and general maintenance



Code	Size	Inner	Master
TC4183	One size fits all	12	120

Type of packaging: Card

HEAVY DUTY LATEX GLOVES

- Made of 100% latex
- For industrial use
- High adherence in dry and wet environments
- High abrasion protection



Code	Cuff	Size	Inner	Master
TC0748	Short	Medium	12	144
TC0749	Short	Large	12	144

Type of packaging: Card

**LATEX-COATED
POLYESTER GLOVES**

- Rugged non-slip design for maximum grip
- Abrasion resistant
- Multi-use



Code	Size	Inner	Master
WF0014	One size fits all	6	120

Type of packaging: Card



**MULTIPURPOSE RUBBER
GLOVES**

- Made of 100% latex
- Food-handling safe
- Durable



Code	Cuff	Size	Inner	Master
WF0017	Length	Medium	12	144
WF0018	Length	Large	12	144

Type of packaging: Card



DISPOSABLE GLOVES

- Made of latex
- Ideal for handling objects in laboratories
- Contains talc inside
- 25 piece box



Code	Size	Inner	Master
WF3606	One size fits all	10	80

Type of packaging: Dispatch box 25 pieces



ELASTIC BACK SUPPORT BELT WITH SUSPENDERS

- Made of polypropylene and elastic
- Velcro closure
- Adjustable suspenders
- 4 rods for lower back support



Code	Size	Inner	Master
TC5195	Small	4	24
TC2696	Medium	4	24
TC2695	Large	4	24
TC2697	Extra Large	4	24

Type of packaging: Bag

ELASTIC MESH BACK SUPPORT BELT WITH SUSPENDERS

- Made of elastic mesh
- Velcro closure
- Adjustable suspenders
- 5 rods for lower back support



Code	Size	Inner	Master
TC5196	Small	4	24
TC5197	Medium	2	24
TC5198	Large	4	24
TC5199	Extra Large	4	24

Type of packaging: Bag

2-PIECE RAIN SUIT

- Polyester lining
- 0.32 mm thick
- PVC 100%
- Jacket hood and overall included



Code	Size	Inner	Master
TC2760	Small	3	20
TC2761	Medium	3	20
TC2762	Large	3	20
TC2763	Extra Large	3	20

Type of packaging: Bag

WATERPROOF RAINCOAT

- Polyester lining
- 0.32 mm thick
- PVC 100%



Code	Size	Inner	Master
TC2806	Small	5	20
TC2805	Medium	5	20
TC2758	Large	5	20
TC2759	Extra Large	5	20

Type of packaging: Bag

PONCHO

- PVC 100% material
- One size fits all



Code	Characteristic	Thickness	Inner	Master
TC2764	Light	0.1 mm	5	30
TC3557	Reinforced	0.2 mm	5	30

Type of packaging: Bag

PONCHO

- Made of polystyrene
- Measurements: 100 x 125 cm



Code	Characteristic	Thickness	Inner	Master
WF9633	Ultra light	0.021 mm	12	200

Type of packaging: Bag

Wolfox

DISPOSABLE COVERALL

- Made of non-abrasive fluid-resistant polypropylene
- With zipper
- Elastic in ankles, wrist and hood



Code	Size	Inner	Master
TC4148	Small	5	25
TC4149	Medium	5	25
TC4150	Large	5	25
TC4151	Extra Large	5	25

Type of packaging: Bag

PLATINUM HANDSAW

- Carbon steel blade
- Blade thickness: 0.9 mm
- 4 clamp screws between blade and handle
- Fine wood handle



Code	Size	DPP	Inner	Master
TC5050	22"	7	6	36
TC5051	24"	6	6	36
TC5052	26"	6	6	36
TC5053	28"	6	6	36

Type of packaging: Bulk

PROFESSIONAL HANDSAW

- Carbon steel blade
- Blade thickness: 0.9 mm
- 3 clamp screws between blade and handle
- Fine wood handle



Code	Size	DPP	Inner	Master
TC0320	18"	9	6	36
TC0321	20"	7	6	36
TC0322	22"	7	6	36
TC0323	24"	6	6	36

Type of packaging: Bulk

BACK SAW

- Carbon steel blade
- Blade thickness: 0.8 mm
- Steel sheet back
- 2 clamp screws between blade and handle



Code	Size	DPP	Inner	Master
TC0325	12"	12	6	36
TC0326	14"	12	6	36

Type of packaging: Bulk

HANDSAW

- Carbon steel blade
- Carbon steel blade
- 2 clamp screws between blade and handle
- Wooden handle



WOLFOX

Code	Size	DPP	Inner	Master
WF0618	16"	7	12	48
WF1666	18"	7	12	48
WF1667	20"	7	12	48
WF1668	22"	7	12	24

Type of packaging: Bulk

MITER SAW

- Blade length: 22"
- Blade width: 1 1/2"
- 5 cutting positions: 90°, 45°, 36°, 30° and 22°
- 14 DPP blade included



Code	Characteristics	Inner	Master
TC0327	22" (558.8 mm)	1	4
Spare parts			
TC0328	18 dpp	4	16
TC0329	24 dpp	4	16

Type of packaging: Box (TC0327) / Card (TC0328, TC0329)

MITER BOX WITH SAW

- Saw blade made of carbon steel
- Plastic box engraved in centimeters inches
- For straight and 45° cutting
- Blade thickness: 0.7 mm



WOLFOX

Code	Size	DPP	Inner	Master
WF0609	12"	12	4	16

Type of packaging: Bulk

12" CIRCULAR SAW FOR METAL

- Tungsten carbide tips
- For cutting non-ferrous metals like aluminum, copper and plastics.



Code	Arbor	Number of teeth	Tooth type	Inner	Master
TC2337	1"	80	TCG	2	6
TC2338	1"	100	TCG	1	6

Type of packaging: Blister

10" CIRCULAR SAW FOR METAL

- Tungsten carbide tips
- For cutting non-ferrous metals like aluminum, copper and plastics.



Code	Arbor	Number of teeth	Type of tooth	Inner	Master
TC2331	5/8"	80	TCG	3	12
TC2334	1"	80	TCG	3	12

Type of packaging: Blister

12" CIRCULAR SAW FOR WOOD

- Tungsten carbide tips



Code	Arbor	Number of teeth	Type of tooth	Inner	Master
TC2335	1"	40	ATB	1	12
TC2336	1"	60	ATB	1	12

Type of packaging: Blister

10" CIRCULAR SAW FOR WOOD

- Tungsten carbide tips



Code	Arbor	Number of teeth	Type of tooth	Inner	Master
TC2329	5/8"	40	ATB	3	12
TC2330	5/8"	60	ATB	3	12
TC2332	1"	40	ATB	3	12
TC2333	1"	60	ATB	3	12

Type of packaging: Blister

7 1/4" CIRCULAR SAW FOR WOOD

- Tungsten carbide tips



Code	Arbor	Number of teeth	Type of tooth	Inner	Master
TC2326	5/8"	16	ATB	4	16
TC2327	5/8"	24	ATB	4	16
TC2328	5/8"	40	ATB	4	16

Type of packaging: Blister

SAWS

BI-METAL HOLE SAW

- For cutting metal sheet, plate, wood, non ferrous metals
- Saw body made of thermally treated tempered steel
- Perforated base for better attachment with hole saw arbor



Code	Diameter	Inner	Master
TC2368	9/16"	6	36
TC2369	5/8"	6	36
TC2370	3/4"	6	36
TC2371	7/8"	6	36
TC2372	1"	6	36
TC2373	1 1/16"	6	36
TC2374	1 1/8"	6	36
TC2375	1 3/16"	6	36
TC2376	1 1/4"	6	36
TC2377	1 3/8"	6	36
TC2378	1 1/2"	6	36
TC2379	1 9/16"	6	36
TC2380	1 3/4"	6	36
TC2381	2"	6	36
TC2382	2 1/8"	6	36
TC2383	2 1/4"	6	36
TC2384	2 3/8"	6	36
TC2385	2 1/2"	6	36
TC2386	2 3/4"	6	36

Type of packaging: Blister

HOLE SAW KIT, 5-PIECES

- For installation of locks, peepholes, etc.
- For drilling on wood and non ferrous metals
- Hole saw arbor



Size
1 1/4"
1 1/2"
2"
2 1/8"

Code	Characteristics	Inner	Master
TC0447	5 pieces	5	20

Type of packaging: Blister

HOLE SAW FOR INSTALLATIONS OF LOCKS, 3-PIECE KIT

- 7/8 spade bit
- Hole saw arbor
- 2 1/8 hole saw



Code	Characteristics	Inner	Master
TC0444	3 pieces	10	40

Type of packaging: Blister

HOLE SAW KIT, 15-PIECE KIT

- For installation of locks, peepholes, etc.
- For drilling on different sizes of wood and non ferrous metals
- Includes:
 - 2 hole saw arbor
 - 1 hex key
 - 12 saws



Contains 12 saws						
3/4"	1	1 1/8"	1	1 1/2"	2	1/4"
7/8"	1	1 1/4"	1	3/4"	2	1/2"
1"	1	3/8"	2"	3"		

Code	Characteristics	Inner	Master
TC2365	15 pieces	3	12

Type of packaging: Plastic Box

HOLE SAW KIT, 8-PIECE

- For installation of locks, peepholes, etc.
- For drilling on wood and non ferrous metals.
- Includes:
 - 2 hole saw arbor
 - Hex Key



Includes 6 saws
1"
1 1/4"
1 1/2"
1 3/4"
2"
2 1/2"

Code	Characteristics	Inner	Master
TC2364	8 pieces	3	12

Type of packaging: Plastic Box

HOLE SAW KIT, 4-PIECE

- For installation of locks, peepholes, etc.
- For drilling on different sizes of wood and non ferrous metals
- Hole saw arbor



Size
7/8"
1"
2 1/8"

Code	Characteristic	Inner	Master
TC2362	4 pieces	6	60

Type of packaging: Blister

ARBOR FOR HOLE SAW

- Threaded steel body for mounting hole saw



Code	Size	Inner	Master
TC2366	9/16" a 1 3/16"	6	72
TC2367	1 1/4" a 2 3/4"	6	36

Type of packaging: Blister

DON'T USE NAILS ADHESIVE

- Multi-purpose adhesive
- Glues materials such as: wood, cement, ceramics, steel and much more.
- Apply on clean and dry bases.
- For indoor and outdoor use
- Temperature range: -40 °C to 90 °C
- 5 kgf / cm² Adhesion



Code	Color	Contents	Inner	Master
TC5379	White	100ml	12	48
TC5373	White	300ml	1	24

Type of packaging: Cartridge / Blister (TC5379)

PVC CEMENT, WET CONDITIONS

- Blue color**
- For use in PVC, CPVC and ABS pipes.
- For wet and dry condition.
- For 40 schedule pipes a maximum diameter of 8" is recommended
- For 80 schedule pipes a maximum diameter of 6" is recommended.
- Regular viscosity, fast drying.



Code	Contents	Inner	Master
TC3392	118 ml / 4oz	12	48
TC3393	236 ml / 8oz	12	48
TC3394	473 ml / 16oz	6	24

Type of packaging: Tin

CPVC CEMENT

- Yellow color**
- For use in PVC and CPVC pipes.
- For wet and dry condition.
- For 40 schedule pipes a maximum diameter of 8" is recommended
- For 80, schedule pipes a maximum diameter of 6" is recommended
- Medium viscosity, fast drying.



Code	Contents	Inner	Master
TC3396	118 ml / 4 oz	12	48
TC3397	236 ml / 8 oz	12	48
TC3398	473 ml / 16 oz	6	24

Type of packaging: Tin

CPVC CEMENT

- Color yellow**
- Resists high pressure and temperatures up to 80°C
- For pipes with a diameter of up to 10 cm (4") 40 and 60 schedule
- 15 min drying time



Code	Contents	Inner	Master
TC3395	60 ml	12	72

Type of packaging: Blister

PVC CEMENT FOR SANITARY USE

- Clear**
- For use in PVC piping.
- For wet and dry condition.
- For 40 schedule pipes a maximum diameter of 6" is recommended
- For 80, schedule pipes a maximum diameter of 4" is recommended
- Regular viscosity, fast drying.



Code	Contents	Inner	Master
TC1628	118 ml / 4oz	12	24
TC1629	236 ml / 8oz	12	24
TC1630	473 ml / 16oz	6	12

Type of packaging: Tin

PVC CEMENT FOR SANITARY USE

- Clear**
- For bonding plumbing piping and PVC fittings.
- For pipes with a diameter of up to 15 cm (6"), 40 schedule.
- 15 min drying time
- Applicator included



Code	Contents	Inner	Master
TC2692	60 ml	12	72

Type of packaging: Blister

CONTACT CEMENT

- Color yellow**
- Use to glue rubber, leather, natural and synthetic sole, plastic, laminated sheet, wood, fiber, cork, aluminum.



Code	Contents	Inner	Master
TC3256	125 ml	6	24
TC3257	250 ml	6	24
TC3258	500 ml	4	24
TC3259	1 lt	4	12

Type of packaging: Tin, blister (TC3255)

CONTACT CEMENT

- Color yellow**
- Use to glue rubber, leather, natural and synthetic sole, plastic, laminated sheet, wood, fiber, cork, aluminum.



Code	Contents	Inner	Master
TC3255	30 ml	12	144

Type of packaging: Tin and Blister (TC3255)

SILICONES | CAULKING GUNS

POLYURETHANE FOAM

- For small household repair, for insulation and sealing of tubes and pipes, as well as filling small gaps.
- Temperature range: 8°C to 50°C

*Note: all foam must be used Once opened, it cannot be stored.



Does not harm the ozone layer



Isolates



Fills



Seals



Code	Contents	Inner	Master
TC2643	250 g / 300 ml	12	12
TC2644	450 g / 500 ml	12	12
TC2645	680 g / 750 ml	6	12

Type of packaging: Tin

SILICON USO GENERAL

- USE TO GLUE
- For indoors and outdoors



Code	Color	Contents	Inner	Master
*TC3288	Clear	85 g	6	48
*TC0316	Clear	300 ml	12	12
*TC0318	White	300 ml	12	12
TC0317	Black	300 ml	12	12

Type of packaging: Cartridge, Blister (TC4131)

KITCHEN AND BATHROOM SILICONE

- Mold resistant
- For places with permanent moisture like kitchens, kitchen and bathroom sink, showers, bathtubs, etc.
- For indoors and outdoors



Code	Color	Contents	Inner	Master
TC4131	Clear	85 g	6	48
*TC3450	Clear	300 ml	12	12
TC3451	White	300 ml	12	12

Type of packaging: Cartridge, Blister (TC4131)

AUTOMOTIVE SILICONE SEALANT

- High temperature resistance
- Range: 0°C - 320°C
- Lasting flexibility even after application



Code	Color	Contents	Inner	Master
TC3384	Black	85 g	6	48
TC3385	Red	85 g	6	48

Type of packaging: Blister

Acrylic Sealant

- To be used in masonry, on brick, walls, aluminum glass.
- Paintable and washable

* Transparent sealer: at the time of application, the sealant has a white color and becomes transparent 24 hours after being applied, this helps to visualize the application of the product on the surface to be worked.



Wolfox

Code	Color	Contents	Inner	Master
WF9640	White	280 ml	1	12
WF0132	Clear	280 ml	12	12

Type of packaging: Cartridge

SILICONE EXHIBITOR TOOLCRAFT

- Made of wire 8 and 11 caliber with black electrostatic paint application.
- Arts in styrene cal 40
- Measurements:
 - Height: 23 cm
 - With: 23 cm
 - Depth: 10 cm



*Does not include product

Code	Capacity
TC5440	6 silicones

REINFORCED SKELETON CAULK GUN

- Double pressure and measuring rod
- Ergonomic handles
- Spring trigger for easier operation



Code	Characteristics	Inner	Master
TC1955	Reinforced	6	24

Type of packaging: Bulk

HEAVY-DUTY CAULK GUN

- Heavy duty die cast metal gun.
- Gator trigger



Code	Characteristics	Inner	Master
TC0227	Spring trigger	12	48

Type of packaging: Bulk

SKELETON CAULK GUN

- Metal gun
- Spring trigger



Wolfox

Code	Characteristics	Inner	Master
*WF6302	Skeleton type	12	48

Type of packaging: Bulk

CAULK GUN WITH GATOR TRIGGER

- Metal gun
- Gator trigger



Wolfox

Code	Characteristics	Inner	Master
WF6301	Spring trigger	24	48

Type of packaging: Bulk

ELECTRIC MINI GLUE GUN

- Made of plastic
- 4" x 5/16" mini electric gun (3 glue sticks included)



Specifications

Voltage	120V-
Frequency	60 Hz
Power	20W

Code	Characteristics	Inner	Master
WF6321	4" x 5/16" Mini gun	6	48
WF6331	12 glue sticks set 4" x 5/16" measurements	24	144

Type of packaging: Blister

ELECTRIC GLUE GUN

- Made of plastic
- 4" x 1/2" Electric Gun (2 glue sticks included)



Specifications

Voltage	120V-
Frequency	60 Hz
Power	20W

Code	Characteristics	Inner	Master
WF6320	4" x 1/2" Gun	6	24
WF6330	6 glue sticks set 4" x 1/2" measurements	24	144

Type of packaging: Blister

WELDING CABLES

- For electric arc welders
- 3 m #4 AWG with connector and ground clamp
- 4.5 m #4 AWG cable with connector (with no electrode base)
- TC2747 and TC3307 can be used with our models



Code	Amperage	Inner	Master
TC3525	250 A	1	6

Type of packaging: Box

ELECTRODE HOLDER

- High temperature resistant fiber glass coating
- Brass connections and clamps
- Different positions available for placing the electrode
- Includes 1 hex key



Code	Amperage	Caliber cable	Inner	Master
TC5239	300 Amperes	2/0 AWG	4	16
TC5240	500 Amperes	4/0 AWG	2	16

Type of packaging: Box

ELECTRODE HOLDER

- High temperature resistant fiber glass coating
- Brass connections and clamps
- Different positions available for placing the electrode
- Includes 1 hex key



GROUND PLIER

- Galvanized steel body with chrome plated finish.
- Brass connections and clamps
- Double safety system for cable



Code	Amperage	Caliber cable	Inner	Master
WF0643	300 Amperes	3 AWG	6	36
WF0644	500 Amperes	2 AWG	6	36

Type of packaging: Box

Code	Amperage	Inner	Master
TC0339	300 Amperes	5	50
TC0340	500 Amperes	5	50

Type of packaging: Box

GROUND PLIER

- Galvanized steel body with chrome plated finish.
- Brass connections and clamps
- Double safety system for cable



6013 ELECTRODE

- Made of soft iron with green coloring coating
- For iron work and household works 2
- For welding overlapping or fillet thin steel sheets on light structures.
- CA/CO reel type



Bag
1 kg
Price per bag



Code	Amperage	Inner	Master
WF0645	300 Amperes	6	36
WF0646	500 Amperes	6	36

Type of packaging: Box

Code	Diameter	Required Amps	Inner	Master
TC2085	3/32"	40 - 90 A	5	20
TC2086	1/8"	110 - 165 A	5	20

Type of packaging: Bag 1 kg

MOSQUITO NET | PLIERS

GREY PLASTIC MOSQUITO NET

- Made of 100% polyethylene
- 15 threads per square inch
- Laminated finish
- Reinforced edges

Code	Size	Inner	Master
TC1013	0.60 m x 30 m	1	1
TC1012	0.75 m x 30 m	1	1
TC1011	0.90 m x 30 m	1	1
*TC1010	1.05 m x 30 m	1	1
TC1009	1.20 m x 30 m	1	1
TC1008	1.50 m x 30 m	1	1
TC1020	1.70 m x 30 m	1	1

Type of packaging: Roll



BLACK PLASTIC MOSQUITO NET

- Made of 100% polyethylene
- 15 threads per square inch
- Laminated finish
- Reinforced edges

Code	Size	Inner	Master
TC1002	0.60 m x 30 m	1	1
TC1003	0.75 m x 30 m	1	1
TC1004	0.90 m x 30 m	1	1
TC1005	1.05 m x 30 m	1	1
TC1006	1.20 m x 30 m	1	1
TC1007	1.50 m x 30 m	1	1

Type of packaging: Roll



GREEN PLASTIC MOSQUITO NET

- Made of 100% polyethylene
- 15 threads per square inch
- Laminated finish
- Reinforced edges

Code	Size	Inner	Master
TC1018	0.60 m x 30 m	1	1
TC1017	0.75 m x 30 m	1	1
TC1016	0.90 m x 30 m	1	1
TC1015	1.05 m x 30 m	1	1
TC1019	1.20 m x 30 m	1	1
TC1014	1.50 m x 30 m	1	1
TC1021	1.70 m x 30 m	1	1

Type of packaging: Roll



TILE NIPPER

- Made of steel
- PVC plastic-coated handles
- Polished body
- Spring keeps them open for easy handling



Code	Size	Inner	Master
TC0244	8 1/2"	4	60

Type of packaging: Blister

END NIPPER PLIERS

- Made of steel
- Non-slip vinyl-coated handles
- Polished body



Code	Size	Inner	Master
TC0307	8"	4	48

Type of packaging: Blister

CARPENTER PLIERS

- Made of steel
- Non-slip vinyl-coated handles
- Polished body



Code	Size	Inner	Master
TC0377	8"	4	60

Type of packaging: Blister

TINNER SPINS

- Body forged on carbon steel
- Straight pattern and tempered by induction
- Safety nut
- Non-slip vinyl-coated handle



Code	Size	Inner	Master
TC0122	7"	3	60
TC0123	10"	3	36
TC0124	12"	3	24
TC0125	14"	3	24

Type of packaging: Card

AVIATION TIN SNIPS

- Forged steel saw blades
- Non-slip dual material handle



Code	Pattern	Inner	Master
TC0120	Right	6	48
TC0119	Left	6	48
TC0121	Straight	6	48

Type of packaging: Cover

MULTIPURPOSE SCISSORS

Wolfox

- Stainless steel blades
- Plastic ergonomic handles



Code	Size	Inner	Master
WF0077	8 1/2"	6	96

Type of packaging: Cover

TAILOR SCISSORS

Wolfox

- Made of Stainless Steel
- Bright polished finish



Glossy finish

Code	Size	Inner	Master
WF0064	8"	4	36
WF0065	10"	4	36
WF0066	12"	4	36

Type of packaging: Cover

SEWING / OFFICE SCISSORS, ENLARGED RING

Wolfox

- Made of Stainless Steel
- Bright polished finish



Glossy finish

Code	Size	Inner	Master
WF0062	6"	6	60
WF0063	7"	6	60

Type of packaging: Cover

SEWING / OFFICE SCISSORS

Wolfox

- Made of Stainless Steel
- Bright polished finish



Glossy finish

Code	Size	Inner	Master
WF0057	4"	12	60
WF0058	5"	12	60
WF0059	6"	12	60
WF0060	7"	12	60
WF0061	8"	12	60

Type of packaging: Cover

HAIR-THINNING SCISSORS

Wolfox

- Made of Stainless Steel
- Bright polished finish



Glossy finish

Code	Size	Inner	Master
WF0067	7 1/2"	6	60

Type of packaging: Cover

HAIR-CUTTING SCISSORS WITH HOOK

Wolfox

- Made of Stainless Steel



Code	Size	Finish	Inner	Master
WF0049	5"	Satin	6	60
WF0051	5"	Bright polished	6	60
WF0050	7"	Satin	6	60
WF0052	7"	Bright polished	6	60

Type of packaging: Cover

HAIR-CUTTING SCISSORS WITHOUT HOOK

Wolfox

- Made of stainless steel



Code	Size	Finish	Inner	Master
WF0053	5"	Satin	6	60
WF0055	5 1/2"	Bright polished	6	60
WF0054	7"	Satin	6	60
WF0056	7 1/2"	Bright polished	6	60

Type of packaging: Cover

TOENAIL CLIPPER

Wolfox

- Made of Stainless Steel
- Bright polished finish



Glossy finish

Code	Size	Inner	Master
WF0070	5 1/2"	4	60

Type of packaging: Cover

NAIL SCISSORS

Wolfox

- Made of Stainless Steel
- Bright polished finish



Glossy finish

Code	Size	Inner	Master
WF0071	4 3/4"	4	60

Type of packaging: Cover

NAIL SCISSORS

Wolfox

- Made of Stainless Steel
- Bright polished finish



Glossy finish

Code	Size	Inner	Master
WF0069	3 1/2"	12	60

Type of packaging: Cover

SCISSORS | BENCH VISES

CUTICLE SCISSORS

- Made of Stainless Steel
- Bright polished finish



Glossy finish

Code	Size	Inner	Master
WF0068	3 1/2"	12	60

Type of packaging: Cover

EMBROIDERY SCISSORS

- Made of Stainless Steel
- Bright polished finish



Glossy finish

Code	Size	Inner	Master
WF0073	4"	12	60

Type of packaging: Cover

HOME / OFFICE SCISSORS

- Made of Stainless Steel
- Plastic ergonomic handles



Code	Size	Inner	Master
WF0074	6"	24	240
WF0075	7"	12	144
WF0076	9"	12	72

Type of packaging: Cover

SCHOOL TYPE SCISSORS

- Blade made of stainless steel
- Plastic ergonomic handles
- Blunt tip



Code	Size	Inner	Master
WF0072	4 1/2"	24	240

Type of packaging: Cover

METAL CHALK LINE REEL

- Strong cotton and polyester line
- 4 oz extra fine blue chalk



Code	Characteristics	Inner	Master
TC0397	Metal / 100 feet with chalk	12	48
TC0399	8 oz chalk spare part	12	60

Type of packaging: TC0397 Blister / TC0399 Bulk

PLASTIC CHALK LINE REEL WITH LEVEL AND CHALK

- Strong cotton and polyester line
- Extra fine blue chalk
- Line level



Code	Length	Inner	Master
TC0398	15 m	12	48
TC0399	8 oz chalk spare part	12	60

Type of packaging: TC0397 Blister / TC0399 Bulk

MULTIPURPOSE BENCH VISE

- Cast Iron body
- Swivel flat base
- Flat base for striking
- Rectified spindle
- Flat and V jaws



Code	Size	Inner	Master
TC5061	5"	1	1

Type of packaging: Box

CROSS-SLIDING BENCH VISE

- Cast Iron body
- Sliding base
- Forged and interchangeable jaws
- Rectified spindle

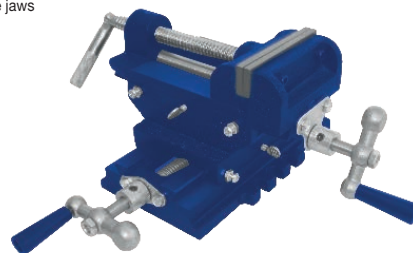

Code	Size	Inner	Master
TC5062	5"	1	1

Type of packaging: Box

INDUSTRIAL BENCH VISE

- Swivel flat base
- Steel body
- Flat base for striking
- Forged and interchangeable jaws
- Rectified spindle



Code	Size	Inner	Master
TC2535	4"	1	1
TC2536	5"	1	1
TC2537	6"	1	1
TC2538	8"	1	1

Type of packaging: Box

LIGHT BENCH VISE

- Swivel flat base
- Steel body
- Flat base for striking
- Forged and interchangeable jaws
- Rectified spindle

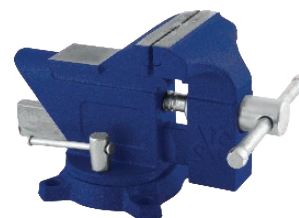

Code	Size	Inner	Master
TC2539	3"	1	4
TC2540	4"	1	4

Type of packaging: Box

METAL MEDICINE CABINET

- Made of varnished steel metal
- Includes lock hasp
- Measurements: - Width: 20.5 cm Height: 29.5 cm - Depth: 6.5 cm



Wolfox

Code	Material	Weight	Inner	Master
WF1201	Metal	1.08 kg	2	18

Type of packaging: Bulk

METAL MAILBOX

- Made of varnished steel metal
- Lid with hinge
- Includes lock hasp
- Measurements: - Width: 18 cm Height: 30.5 cm Depth: 8.5 cm



Wolfox

Code	Material	Weight	Inner	Master
WF1202	Metal	0.98 kg	2	18

Type of packaging: Bulk

DOG CHAIN

- Made of chrome steel
- Nylon handle

Wolfox



Code	Link diameter	Length	Leash color	Inner	Master
WF1654	2 mm	1.2 m	Blue	12	144
WF1655	2.5 mm	1.2 m	Blue	12	144
WF1656	3 mm	1.2 m	Blue	12	72
WF1657	3.5 mm	1.2 m	Blue	12	72
WF1658	4 mm	1.2 m	Blue	12	72
WF9737	2 mm	1.2 m	Red	12	144
WF9738	2.5 mm	1.2 m	Red	12	144
WF9739	3 mm	1.2 m	Red	12	72
WF9740	3.5 mm	1.2 m	Red	12	72
WF9741	4 mm	1.2 m	Red	12	72

Type of packaging: Bag

BICYCLE PADLOCK

- Steel cable coated in PVC
- Includes 2 keys

Wolfox



Code	Length	Inner	Master
WF8907	58 cm	12	120

Type of packaging: Hanger

4 1/2 DOUBLE SUCTION CUP

- Polypropylene body
- Rubber disks
- For lifting and moving smooth-surface, heavy objects.

4 1/2" SINGLE SUCTION CUP

- Polypropylene body
- Rubber disks
- For lifting and moving smooth-surface, heavy objects.



Code	Maximum load capacity	Inner	Master
TC4660	70 kg	2	24

Type of packaging: Box



Code	Maximum load capacity	Inner	Master
TC4659	50 kg	4	48

Type of packaging: Box

DOG CHOKE CHAIN

- Made of chrome steel
- Ring in both ends

Wolfox



Code	Link diameter	Length	Inner	Master
WF1659	2 mm	40 cm	12	144
WF1660	2.5 mm	45 cm	12	144
WF1661	3 mm	50 cm	12	144
WF1662	3.5 mm	55 cm	12	72
WF1663	4 mm	65 cm	12	72

Type of packaging: Bag

4-DIGIT HAND TALLY COUNTER

- Made of chrome metal
- Easy to read and reset
- 4-digit reading

Wolfox



Code	Characteristics	Inner	Master
WF1890	4 digit	12	48

Type of packaging: Blister

ICE PICK

- Tempered carbon steel
- Wooden handle

Wolfox



Code	Size	Inner	Master
WF1350	7"	24	96

Type of packaging: Bulk

DRAIN AUGER

- Polypropylene body and handle
- Stainless steel cable that works as screw driver
- Conic guide



Code	Length	Inner	Master
TC3378	4.5 m	4	12
TC2084	7.6 m	4	12

Type of packaging: Bulk

RUBBER PLUNGER

- Made of rubber
- 40 cm wood handle
- For toilet, sink and dishwasher pipes.



Wolfox

Code	Diameter	Inner	Master
WF1696	6"	20	40

Type of packaging: Bulk

9W ELECTRONIC INSECT KILLER

- Includes an useful tray to collect bugs on the lower part of the insect killer.
- Safe insect killer
- Ultraviolet light wavelength: 365 mm
- Lamp shelf life: more than 5,000 hours



Wolfox

IMPROVED PRODUCT

NOM

Code	Power	Frequency	Tension	Inner	Master
WF9730	9W	60 Hz	120 V~	2	16

Type of packaging: Box

BUG ZAPPER RACKET

- Rechargeable
- Powerful 2-layer grid for catching and eliminating flying insects
- It has a led lamp
- Safe insect killer
- Retractable plug



Wolfox

Code	Characteristics	Frequency	Tension	Inner	Master
WF9731	Rechargeable battery	60Hz	120 V~	6	24

Type of packaging: Bag

LINOLEUM KNIFE

- High carbon steel blade
- Wood handle
- For linoleum, vinyl, etc.



Code	Size	Inner	Master
TC0305	7 1/2" (190 mm)	12	120

Type of packaging: Blister

KITCHEN KNIFE POLYPROPYLENE HANDLE

- Stainless steel blade
- Fixed with aluminum rivets
- Smooth edge



Wolfox



Code	Size	Inner	Master
WF1712	6"	12	60
WF1713	7"	12	60
WF1714	8"	12	60

Type of packaging: Blister

TABLE KNIFE PLASTIC HANDLE

- Stainless steel blade
- Fixed with aluminum rivets



Wolfox



Code	Edge	Size	Inner	Master
WF1715	Serrated	5"	24	120
WF1716	Smooth	5"	24	120

Type of packaging: Blister

STRAIGHT KNIFE WOODEN HANDLE

- Stainless steel blade
- Fixed with aluminum rivets
- Smooth edge



Wolfox



Code	Size	Inner	Master
WF1707	5"	12	60
WF1708	6"	12	60
WF1709	7"	12	60
WF1710	8"	12	60
WF1711	9"	12	60

Type of packaging: Blister

KITCHEN KNIFE WOODEN HANDLE

- Stainless steel blade
- Fixed with aluminum rivets
- Smooth edge



Wolfox



Code	Size	Inner	Master
WF1703	5"	12	60
WF1704	6"	12	60
WF1705	7"	12	60
WF1706	8"	12	60

Type of packaging: Blister

TABLE KNIFE WOODEN HANDLE

- Stainless steel blade
- Fixed with aluminum rivets



Wolfox



Code	Edge	Size	Inner	Master
WF1701	Serrated	5"	24	120
WF1702	Smooth	5"	24	120

Type of packaging: Blister

HIGH CARBON SEMICONIC TAP

- For pipe connections and inner thread



*Price per piece

Code	Size	Thread type	Channels	Inner	Master
TC1381	1/8" x 27	NPT	4	2	72
TC1382	1/4" x 18	NPT	4	2	72
TC1383	3/8" x 18	NPT	4	2	72
TC1384	1/2" x 14	NPT	4	2	20

Type of packaging: Bulk

HIGH CARBON SEMICONIC TAP

- For hand-threaded applications
- For all general purpose threading



NC: Standard rope
NF: Fine rope

*Price per piece

Code	Size	Thread type	Channels	Inner	Master
TC1335	1/8" x 40	NC	3	3	180
TC1336	5/32" x 32	NC	3	3	180
TC1337	3/16" x 24	NC	3	3	105
TC1338	1/4" x 20	NC	3	3	90
TC1340	5/16" x 18	NC	3	3	90
TC1342	3/8" x 16	NC	3	3	30
TC1344	7/16" x 14	NC	3	3	30
TC1346	1/2" x 13	NC	3	3	30
TC1348	9/16" x 12	NC	3	3	30
TC1350	5/8" x 11	NC	3	3	18
TC1352	3/4" x 10	NC	3	3	21

Type of packaging: Bulk

24-PIECE TAP AND DIE SET

- Case with 24 pieces
- Includes:
 - 1 25.4 mm ø1 round handle for dies
 - 1 1.5 mm - 1/6" straight type tap wrench
- Taps and dies made of high carbon steel
- 1 plastic case for easy transportation of tools and accessories



Code	Characteristics	Inner	Master
TC2870	24 pieces	1	8

Tipo de empaque: Case

CUTTING HAIR MACHINE FAMILY KIT



- 120 V- 60Hz
- Wireless cutting hair machine and accessories
- Includes:
 - 2 combs
 - 1 oil
 - 1 cleaning brush
 - 4 Guide Combs (3mm, 6mm, right guide and left guide)
- Domestic use



Code	Power	Inner	Master
WF1664	10.5 W	1	12

Type of packaging: Blister

CUTTING HAIR MACHINE KIT



- 120 V- 60Hz
- Wireless cutting hair machine and accessories
- Includes:
 - 1 comb
 - 1 oil
 - 1 cleaning brush
 - 2 guide combs adjustable to 7 heights
 - 6 guide combs (3mm, 6mm, 9mm, 12mm, right guide and left guide)
- Professional use



Code	Wired power	Wireless power	Inner	Master
WF1665	10,5 W	3 W	1	12

Type of packaging: Blister

ANGLE STOP VALVE 1/2" X 1/2" WITHOUT LOCKNUT



- Made of zinc
- NPT Taps
- Satin finish
- ABS Handle



More angular keys in the **YARDEN** section Page 226

Code	Maximum pressure	Inner	Master
WF9659	100 PSI	6	240

Type of packaging: Bulk

ANGLE STOP VALVE 1/2" X 1/2" WITHOUT LOCKNUT



- Made of zinc
- NPT Taps
- Chrome finish
- ABS Handle



More angular keys in the **YARDEN** section Page 226

Code	Maximum pressure	Inner	Master
WF9660	100 PSI	6	240

Type of packaging: Bulk

4" BATHROOM FAUCET



- Brass assembly ABS body and handles
- Ceramic cartridge
- 1/4" turn
- With aerator



More mixer keys in the **YARDEN** section Page 218

Code	Handle	Inner	Master
*WF9510	Lever	2	40

Type of packaging: Box

8" KITCHEN FAUCET GOOSE NECK



- Brass assembly ABS body and handles
- Ceramic cartridge
- 1/4" turn
- With aerator



More mixer keys in the **YARDEN** section. Page 218.

Code	Handle	Inner	Master
*WF9509	Lever	2	20

Type of packaging: Box

MOUNTABLE MANUAL MEAT MINCER



- Tinned iron body
- Mill with low hopper
- Spare blade included



Code	Characteristics	Inner	Master
WF1643	#12	2	6
WF1644	#22	1	2
WF1645	#32	1	2

Type of packaging: Box

MANUAL MINCER FOR PRESSED MEAT



- Tinned iron body
- Mill with low hopper
- Pressed type fitting
- Spare blade included



Code	Characteristics	Inner	Master
WF1640	#5	2	6
WF1641	#8	2	6
WF1642	#10	2	4

Type of packaging: Box

GRAIN MILL



- Tinned iron body
- Mill with low hopper
- Pressed type fitting
- For cereal and grain



Code	Characteristics	Inner	Master
WF2541	MANUAL MILL	2	6

Type of packaging: Box

VARIOUS | VERNIER | FISHING EQUIPMENT

6" ANALOG VERNIER WITH CASE

- Made of stainless steel
- Etched with 2 measuring scales (cms and inches)
- Tolerance: 0.002" / 0.05 mm
- Includes plastic case



Code	Length	Inner	Master
TC4565	6"	2	24

Type of packaging: Case

6" ANALOG VERNIER

- Made of carbon steel
- Etched with 2 measuring scales (cms and inches)
- Tolerance: 0.016" / 0.4 mm



Code	Length	Inner	Master
WF0599	6"	6	72

Type of packaging: Blister

Wolfox

5" ANALOG PLASTIC VERNIER

- Etched with 2 measuring scales (cms and inches)
- With metal guide and support
- Recommended for school and domestic use



Code	Length	Inner	Master
WF9725	5"	10	120

Type of packaging: Bag

Wolfox

FISHING ROD WITH REEL

- Fiber glass fishing rod with graphite
- Open line reel with anti-lock system
- 2-position handle and 2-section rod
- Reinforced grommets



Code	Rod length	Inner	Master
WF6101	1.8 m	2	10
WF6102	2.1 m	2	10

Type of packaging: Blister

Wolfox

TELESCOPIC FISHING ROD WITH REEL AND ACCESSORIES

- Open line reel with anti-lock system
- 2-position handle
- Fiber glass fishing rod and reinforced grommets
- Includes:
 - 1 fishing rod
 - 1 reel
 - 1 fishing bait
 - 1 float
 - 1 fishing lure
 - 3 fishing sinkers
 - 5 fishing hooks with line



Code	Rod length	Inner	Master
WF6103	1.8 m	2	20
WF6104	2.1 m	2	20

Type of packaging: Blister

Wolfox

MULTICOLOR NYLON FISHING LINE

- 100% Polyamide
 - High resistance
 - 100m reel
 - Multi-use
- (Plumbing, construction, handcrafts, etc)



Box
10 threads

Code	Gauge	Inner	Master
WF9513	0.30 mm	10	240
WF9514	0.35 mm	10	240
WF9515	0.40 mm	10	240
WF9516	0.50 mm	10	240
WF9517	0.60 mm	10	240
WF9518	0.70 mm	10	240
WF9519	0.80 mm	10	180
WF9520	0.90 mm	10	180
WF9521	1 mm	10	180

Type of packaging: Reel

Wolfox

BLUE NYLON FISHING LINE

- 100% Polyamide
 - High resistance
 - 100m reel
 - Multi-use
- (plumbing, construction, handcrafts, etc)



Box
10 threads

Code	Gauge	Inner	Master
WF9696	0.30 mm	10	240
WF9697	0.35 mm	10	240
WF9698	0.40 mm	10	240
WF9699	0.50 mm	10	240
WF9700	0.60 mm	10	240
WF9701	0.70 mm	10	240
WF9702	0.80 mm	10	180
WF9703	0.90 mm	10	180
WF9704	1 mm	10	180

Type of packaging: Reel

Wolfox

FISH HOOK, 100 PIECES BOX

- Made of high-carbon steel
- Nickel coating
- Round eye
- "Knife edge" straight tip
- Blister presentation (100 pieces)



Box
100 pieces
*Price per blister

Code	Size	Inner	Master
WF9381	#8	10	80
WF9382	#9	10	160
WF9383	#10	10	160
WF9384	#11	10	160
WF9385	#12	10	160
WF9386	#13	10	160
WF9387	#14	10	160
WF9388	#15	10	160
WF9389	#16	10	160
WF9390	#18	10	160
WF9391	#20	10	160

Type of packaging: Blister

Wolfox



fulgore

ILUMINATION

**ELECTRIC
ARTIFACTS**

WIRES

MULTIMETERS

VIDEO AND TELEPHONY

HOME



LED BULB | BULB TYPE

- Lights up instantly
- For indoor and outdoor use
- Energy saving and lower heat emission
- Do not use with light dimmers
- Available in three types of light color



Warm: 2,700 K



Cold: 5,000 K



Dia, 6,500 K

Base	Voltage	Frequency	Lifespan
E27	120 - 240 V~	60 Hz	15,000 hr

NOM

MODEL
[A19]

LED
LIGHT

WARM LIGHT

Code	Watts	Light similar to	Lumens	Inner	Master
FP0208	5 W	35 W	450 lm	10	60
FP0211	9 W	50 W	720 lm	10	60
FP0214	12 W	60 W	1,200 lm	10	60
FP0217	15 W	70 W	1,400 lm	10	60
FP0220	18 W	90 W	1,600 lm	10	60

COLD LIGHT

FP0207	5 W	35 W	450 lm	10	60
FP0210	9 W	50 W	720 lm	10	60
FP0213	12 W	60 W	1,200 lm	10	60
FP0216	15 W	70 W	1,400 lm	10	60
FP0219	18 W	90 W	1,600 lm	10	60

DAYLIGHT

FP0206	5 W	35 W	450 lm	10	60
FP0209	9 W	50 W	720 lm	10	60
FP0212	12 W	60 W	1,200 lm	10	60
FP0215	15 W	70 W	1,400 lm	10	60
FP0218	18 W	90 W	1,600 lm	10	60

Type of packaging: Blister

- Lights up instantly
- For indoor and outdoor use
- Energy saving and lower heat emission
- Do not use with light dimmers

LED
LIGHT



FU1678



FU1679



FU1680



FU1681

NEW
PRODUCT

NOM



Dia, 6,500 K

HIGH WATAGE LED BULB, DAYLIGHT

Code	Watts	Light similar to	Lumens	Inner	Master
FU1678	30 W	140 W	2,400 lm	2	24
FU1679	40 W	205 W	3,200 lm	2	24
FU1680	50 W	250 W	4,000 lm	2	12
FU1681	75 W	375 W	6,000 lm	1	48

Type of packaging: Box



LED LIGHT

GU-10 LED BULB - Do not use with dimmers

Code	Type of light	Watts	Light similar to	Lumens	Inner	Master
FP0083	Daylight	5 W	35 W	300 lm	12	48
FP0084	Warm light	5 W	35 W	300 lm	12	48
FP0086	Daylight	7 W	40 W	500 lm	12	48
FP0085	Warm light	7 W	40 W	500 lm	12	48

LED MR-16 BULB

FP0079	Daylight	5 W	35 W	300 lm	12	48
FP0080	Warm light	5 W	35 W	300 lm	12	48
FP0081	Daylight	7 W	40 W	500 lm	12	48
FP0082	Warm light	7 W	50 W	500 lm	12	48

LED JDR BULB (E-27)

FP0087	Daylight	5 W	35 W	300 lm	12	48
FP0088	Warm light	5 W	35 W	300 lm	12	48
FP0089	Daylight	7 W	40 W	500 lm	12	48
FP0090	Warm light	7 W	50 W	500 lm	12	48

Type of packaging: Box



FP0083 - FP0086



FP0079 - FP0082



FP0087 - FP0090

NOM



Voltage	Frequency	Lifespan
120 V - 220 Vca	60 Hz	15,000 hr



Warm: 2,700 K



Dia, 6,500 K



FP0187 / FP0190



FP0186 / FP0189



FP0185 / FP0188

LED LIGHT

- For indoor and outdoor use
- Do not use with light dimmers
- Energy saving and lower heat emission against dichroic reflectors

PAR LED BULB

Code	Product	Type of light	Watts	Light similar to	Lumens	Inner	Master
FP0187	LED bulb, PAR-38	Daylight	13 W	75 W	950 lm	12	48
FP0190	LED bulb, PAR-38	Warm light	13 W	75 W	950 lm	12	48
FP0186	LED bulb, PAR-30	Daylight	10 W	55 W	750 lm	12	48
FP0189	LED bulb, PAR-30	Warm light	10 W	55 W	750 lm	12	48
FP0185	LED bulb, PAR-20	Daylight	7 W	40 W	450 lm	12	48
FP0188	LED bulb, PAR-20	Warm light	7 W	40 W	450 lm	12	48

Type of packaging: Box

Base	Voltage	Frequency	Lifespan
E27	120 V - 220 Vca	60 Hz	15,000 hr



Warm: 2,700 K



Dia, 6,500 K

NOM



FP0183 / FP0184

FP0099 / FP0100

LED LIGHT

NOM

TUBE [T8]

Voltage	Frequency	Lifespan
120 V - 220 Vca	60 Hz	15,000 hr



Dia, 6,500 K

LED TUBE, DAYLIGHT

- Aluminum body - Polycarbonate diffuser

Code	Product	Length	Watts	Light similar to	Lumens	Inner	Master
FP0183	White LED tube	60 cm	10 W	40 W	800 lm	5	20
FP0184	White LED tube	120 cm	19 W	80 W	1,600 lm	5	20
FP0099	Transparent LED tube	60 cm	9.5 W	40 W	800 lm	5	20
FP0100	Transparent LED tube	120 cm	19 W	80 W	1,600 lm	5	20

Type of packaging: Box



- For indoor and outdoor use
- Dimeable

NOM



Warm: 2,700 K

LED R BULB, WARM LIGHT

Code	Watts	Light similar to	Lumens	Inner	Master
FP1210	8W	45W	450	4	48
FP1211	13W	65W	750	4	48
FP1212	16W	75W	1,065	4	48

Type of packaging: box



ENERGY-EFFICIENT | SPIRAL



- Lights up instantly
- For indoor and outdoor use
- High luminous flux
- Saves 75% energy
- Do not use with light dimmers
- Excellent light distribution



Dia, 6,500 K

Base	Voltage	Frequency	Lifespan
E-27	120 V~	60 Hz	10,000 hr



TUBE

NOM [T5]



FU0692



FU0267



FU0693



FU0694



FU1041

SPIRAL ENERGY-EFFICIENT, LIGHT BULB, DAYLIGHT

Code	Watts	Light similar to	Lumens	Current	Inner	Master
FU0692	45 W	45 W = 150 W	2,700 lm	550 mA	5	20
FU0267	65 W	65 W = 300 W	4,225 lm	765 mA	5	25
FU0693	85 W	85 W = 400 W	5,525 lm	985 mA	5	20
FU0694	105 W	105 W = 500 W	6,825 lm	1.30 A	5	20
FU1041	120 W	120 W = 600 W	7,800 lm	1.60 A	2	12

Type of packaging: Box

MINI SPIRAL ENERGY-EFFICIENT

DAYLIGHT

Base	Voltage	Frequency	Lifespan
E27	120 V~	60 Hz	10,000 hr

Code	Watts	Light similar to	Lumens	Current	Inner	Master
FU0686	9 W	9 W = 40 W	450 lm	120 mA	12	60
FU0027	11 W	11 W = 50 W	550 lm	135 mA	12	60
FU0028	13 W	13 W = 55 W	650 lm	155 mA	12	60
FU0768	15 W	15 W = 60 W	780 lm	205 mA	4	24
FU0769	20 W	20 W = 80 W	1,140 lm	260 mA	4	24
FU0770	25 W	25 W = 90 W	1,500 lm	330 mA	4	24

4 PIECES

FU0863	20 W	20 W = 80 W	1,140 lm	260 mA	10	10
FU0864	25 W	25 W = 90 W	1,500 lm	330 mA	10	10

WARM LIGHT

FU0317	11 W	11 W = 50 W	550 lm	135 mA	12	60
FU0319	15 W	15 W = 60 W	780 lm	205 mA	12	60
FU0320	20 W	20 W = 80 W	1,140 lm	260 mA	12	60
FU0321	25 W	25 W = 90 W	1,500 lm	330 mA	12	60

Type of packaging: Blister



- Lights up instantly
- Saves 75% energy
- Do not use with light dimmers

TUBE
[T2]

NOM



Dia, 6,500 K



Warm: 2,700 K





- Lights up instantly
- Saves 75% energy
- Do not use with light dimmers

3U ENERGY-EFFICIENT, DAYLIGHT

Base	Voltage	Frequency
E27	120 V~	60 Hz



TUBE
[T4]

Code	Watts	Light similar to	Lumens	Current	Lifespan	Inner	Master
FU0022	15 W	15 W = 60 W	780 lm	205 mA	10,000 hr	12	60
FU0024	20 W	20 W = 80 W	1,140 lm	260 mA	10,000 hr	12	60
FU0026	25 W	25 W = 90 W	1,500 lm	330 mA	10,000 hr	12	60

Type of packaging: Blister



- Lights up instantly
- Saves 75% energy
- Do not use with light dimmers

2U ENERGY-EFFICIENT, DAYLIGHT

Base	Voltage	Frequency
E27	120 V~	60 Hz



TUBE
[T4]

Code	Watts	Light similar to	Lumens	Current	Lifespan	Inner	Master
FU0016	9 W	9 W = 40 W	450 lm	120 mA	10,000 hr	12	60
FU0018	11 W	11 W = 50 W	550 lm	135 mA	10,000 hr	12	60
FU0020	13 W	13 W = 55 W	650 lm	155 mA	10,000 hr	12	60

Type of packaging: Blister



- Lights up instantly
- Saves 75% energy
- Do not use with light dimmers

ENERGY-EFFICIENT GLOBE LIGHT BULB, DAYLIGHT

Base	Voltage	Frequency
E27	120 V~	60 Hz



Code	Watts	Light similar to	Lumens	Current	Lifespan	Inner	Master
FU0032	15 W	15 W = 50 W	650 lm	150 mA	10,000 hr	10	20
FU0865	25 W	25 W = 80 W	1,125 lm	320 mA	10,000 hr	5	20
FU1102	30 W	30 W = 110 W	1,750 lm	425 mA	10,000 hr	5	20

Type of packaging: Blister



- Lights up instantly
- Saves 75% energy
- Do not use with light dimmers

SPIRAL ENERGY-EFFICIENT LIGHT BULB, DAYLIGHT

Base	Voltage	Frequency
E27	120 V~	60 Hz



TUBE
[T4]

Code	Watts	Light similar to	Lumens	Current	Lifespan	Inner	Master
FU0029	15 W	15 W = 60 W	780 lm	205 mA	10,000 hr	12	60
FU0030	20 W	20 W = 80 W	1,140 lm	260 mA	10,000 hr	12	60
*FU0031	25 W	25 W = 90 W	1,500 lm	330 mA	10,000 hr	12	60
FU1043	30 W	30 W = 105 W	1,950 lm	350 mA	10,000 hr	10	60

Type of packaging: Blister



LIGHTING | CIRCULAR LAMPS | LIGHT BULBS | LAMPHOLDER



FU0040 / FU0043

- Do not use with dimmer
- Illuminates similar to the 70 W spotlights



FU0041 / FU0042

- FU0041 is spare parts FU0040
- FU0042 is spare parts FU0043
- Design to work with fluorescent light bulb electronic ballasts T9

CIRCULAR LIGHT BULB, DAYLIGHT

Base	Voltage	Frequency	Lifespan
E27	120 V~	60 Hz	6,000 hr



Dia, 6,500 K

TUBE
[T9]

Code	Watts	Light similar to	Lumens	Inner	Master
FU0040	22 W	70 W	770	20	20
FU0043	32 W	120 W	1,200	20	20
FU0041	22 W	70 W	770	20	20
FU0042	32 W	120 W	1,200	20	20

Type of packaging: Box



FIXED CROWN LIGHT BULB

· The clear and opaque models contain 10 lightbulbs of each colors: blue, orange, green, red and yellow

Base	Voltage	Frequency	Lifespan
E12	120 V~	60 Hz	1,200 hr

Code	Color	Watts	Lumens	Inner	Master
FU0052	Clear	7.5 W	36	250	2000
FU0054	Transparent	7.5 W	38	250	2000

It is delivered in a box with 50 pieces

INTERMITTENT CROWN LIGHT BULB

FU0055	Clear	7.5 W	36	100	2000
FU0057	Transparent	7.5 W	38	100	2000

Type of packaging: Box



FU0302 / FU0360



FU0303



FU0304



FU0300 / FU0301

LIGHT BULB

- Frecuencia 60 Hz

Voltage	Frequency	Lifespan
120 V~	60 Hz	1,200 hr

Code	Product	Color	Base	Watts	Lumens	Inner	Master
FU0302	Flame light bulb	Pearl	E27	40 W	340 lm	100	400
FU0360	Flame light bulb	Clear	E27	40 W	380 lm	100	400
FU0303	Candle light bulb	Clear	E27	40 W	380 lm	100	400
FU0304	Candle light bulb	Clear	E14	40 W	380 lm	100	400
FU0300	Oven / Fridge light bulb	Pearl	E27	40 W	360 lm	100	400
FU0301	Oven / Fridge light bulb	Pearl	E27	25 W	190 lm	100	40

Type of packaging: Box



FU0870

- 120 V~
- Halogen dichroic reflector
- For indoor use



FU0871

- Base for dichroic MR16 flood light bulb and LED
- Includes lamp holder, ground cable and fastening ring (does not include reflector, nor voltage reducer)



FU0872

- Base for MR16 flood light bulb and LED
- 15 cm cables
- To operate at 12 V ~ (purchase separately to reduce the voltage)

FLOOD LIGHT BULB HOLDER

Voltage	Frequency	Lifespan
120 V~	60 Hz	2,000 hr

Code	Product	Watts	Temperature	Inner	Master
FU0870	MR-16 Flood light bulb	50 W	2,700 K	20	200
FU0871	Flood light bulb base and holder	50 W	-	12	48
FU0872	Flood light bulb lamp holder	50 W	-	50	600

Type of packaging: Box FU0872 Bag

NOM



LED
LIGHT



FU1386



FU1387



FU1388

- Aluminium box
- Tempered glass
- Hermetic seal for indoor and outdoor use
- Power cable: 30 cm (3 x18 AWG)
- Light temperature: 6,500 K
- The sensor works during the day and night
- Sensor:
 - Detection range 8-12m
 - Detection angle: 120 °
- High-potency LED

*Waterproof
IP65



Dia, 6,500 K

NOM

MOTION SENSOR LED LIGHT BULBS, DAYLIGHT

Code	Watts	Light similar to	Lumens	Inner	Master
FU1386	20 W	200 W	1,600 lm	1	10
FU1387	30 W	300 W	2,400 lm	1	4
FU1388	50 W	500 W	4,000 lm	1	4

Type of packaging: Box



FU1670



FU1671



FU1672



FU1673



FU1674

NEW
PRODUCT

LED
LIGHT

- Aluminium box
- 4 mm tempered glass
- Hermetic seal for indoor and outdoor use
- Power cable: 30 cm (3 x18 AWG)
- High-potency LED

*Waterproof
IP65



Dia, 6,500 K

NOM

TYPE OF PACKAGING: BOX

Code	Watts	Lumens	Inner	Master
FU1670	20 W	1,600 lm	1	10
FU1671	30 W	2,400 lm	1	10
FU1672	50 W	4,000 lm	1	4
FU1673	100 W	8,000 lm	1	2
FU1674	150 W	12,000 lm	1	2

Type of packaging: Box



FP0200



FP0201



FP0202



FP0203

NEW
PRODUCT

LED
LIGHT

- Aluminum box
- 4 mm tempered glass
- Hermetic seal for indoor and outdoor use
- Power cable: 30 cm (3 x18 AWG)
- High-potency LED

*Waterproof
IP65



Dia, 6,500 K

NOM

ULTRA THIN LED FLOODLIGHT, DAYLIGHT

Code	Watts	Lumens	Inner	Master
FP0200	10 W	700 lm	2	24
FP0201	20 W	1,500 lm	2	24
FP0202	30 W	2,400 lm	2	20
FP0203	50 W	3,800 lm	1	12

Type of packaging: Box





FP0052

- Works with 4 *AAA* batteries not included



FP0051

- Easy to adhere, includes self adherent strip on the back
- Works with 3 (AAA) batteries not included

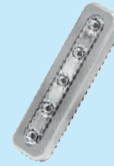

FP0053

- Easy to adhere, includes self adherent strip on the back
- Works with 3 (AAA) batteries not included

LED LIGHT



MULTIPURPOSE TOUCH LED

- Portable

Code	Product	Voltage	Lumens	Lifespan	Inner	Master
FP0052	Round 14 cm	6 V	25 lm	30,000 hr	12	48
FP0051	Round 7 cm (2-piece set)	4.5 V	9 lm	30,000 hr	12	48
FP0053	Rectangular 18 x4.5 cm	4.5 V	15 lm	30,000 hr	12	48

Type of packaging: Blister



- Aluminum base
- Polycarbonate screen
- Includes power cable (without plug) and interconnection cable
- Lightbulb body: 1.8cm wide x 3.2cm high

* Can connect more than 2 luminaires simultaneously

TYPE OF PACKAGING: BOX

Voltage	Frequency	Lifespan
110 - 220 V~	60 Hz	40,000 hr



Dia, 6,500 K

NOM

Code	Length	Watts	Lumens	# LEDS	Inner	Master
FU1434	60 cm	18W	1,440 lm	96	3	20
FU1435	120 cm	36W	2,880 lm	192	2	20

Type of packaging: Box



- Base made of ABS
- Includes power cable and interconnection
- Light bulb body: 3.3 cm wide x 3.5 cm high

* Can connect more than 2 luminaires simultaneously

CABINET LED LIGHT BULB

Voltage	Frequency	Lifespan
110 - 220 V~	60 Hz	30,000 hr



Dia, 6,500 K

NOM

Code	Length	Watts	Lumens	# LEDS	Inner	Master
FU1331	30 cm	6 W	500 lm	48	4	20
FU1332	60 cm	11 W	950 lm	72	4	20
FU1333	90 cm	19 W	1,650 lm	96	4	20
FU1334	120 cm	24 W	2,100 lm	120	4	20

Type of packaging: Box



FU0785



FU0581



FU0580

- Includes rechargeable battery
- Lights up automatically when there is no power
- Light-up nylon strap (Except FU0580)
- Charging cable included
- 2 functions: lamp and emergency lamp

EMERGENCY LIGHT TORCH, DAYLIGHT

Voltage	Frequency
120 V~	60 Hz



Dia, 6,500 K

NOM

Code	Watts	Length	# LEDS	Battery	Battery life	Inner	Master
FU0785	5 W	66.5 cm	90	3 x 4 V	20 hr	2	6
FU0581	5 W	40 cm	60	2 x 4 V	20 hr	4	16
FU0580	3 W	21 cm	30	2 x 4 V	13 hr	4	16

Type of packaging: Box





FU0013



FU1119

- Wall mounting
- Photocell with motion sensor and brightness sensor
- Sensors with motion sensitivity adjustment
- It does not work when exposed to light
- Sensor:
 - Maximum detection areas: 9 m
- Detection angle: 180°
- Timer: 10 sec to 7 min
- Bulbs not included

***Waterproof IP44**

MOTION SENSOR LIGHT PAR 38

Code	Color	Max watts	Inner	Master
FU0013	Black	300 W	4	24
FU1119	White	300 W	4	24

Type of packaging: Box

NOM



FU1118



FU1117

- Made of polycarbonate
- Sensor coverage radius: 1 to 9 m
- Timer: 10 sec to 5 min
- Bulbs not included

INFRARED MOTION SENSOR LIGHT

Code	Color	Max watts	Inner	Master
FU1118	Black	60 W	4	20
FU1117	White	60 W	4	20

Type of packaging: Box

NOM



- Installation: Ceiling / wall
- Smoke alarm with buzzer
- Button with LED indicator
- Alarm voltage: 6.5 V ~ 7.5 V
- Alarm volume: > 85 db (3 m)
- Battery: DC 9 V (included)
- Working temperature range: -10 °C a 40 °C



- Installation: ceiling
- It does not work when exposed to solar light
- For indoor use
- Maximum detection area: 6m - 360°
- With 3 option adjustment switch
- Timer: 10 sec to 7 min
- Includes 2 screws and 2 pegs for installation



Voltage	Frequency
120 V~	60 Hz



NOM

SMOKE DETECTOR

Code	Characteristics	Inner	Master
FU0916	Smoke detector	2	24

Type of packaging: Blister

MOTION SENSOR FOR CEILING

Code	Max watts	Inner	Master
FU0794	800 W	4	24

Type of packaging: Blister



- Installation: Ceiling / wall
- It does not work when exposed to solar light
- For indoor and outdoor use
- Maximum detection area: 6m - 360°
- Timer: 10 sec to 5 min
- For energy-efficient and incandescent bulb

NOM



- For indoor use
- Detection angle: 110°
- Maximum detection area: 9m - 110°
- Sound level: 60 db
- Installation: wall
- Uses one 9 V alkaline battery (not included)

NOM



ALARM AND INTRUDER ALERT WITH MOTION SENSOR

Code	Voltage	Inner	Master
FU0793	9 V	4	24

Type of packaging: Blister



- Installation: ceiling
- It does not work when exposed to solar light
- For indoor and outdoor use
- Maximum detection area: 8m - 180°
- Timer: 15 sec to 11 min

NOM



WALL MOTION SENSOR

Code	Max watts	Inner	Master
FU0795	800 W	4	24

Type of packaging: Blister

SOCKET WITH MOTION SENSOR

Code	Max watts	Inner	Master
FU0904	60 W	4	48

Type of packaging: Blister

Voltage	Frequency
120 V~	60 Hz

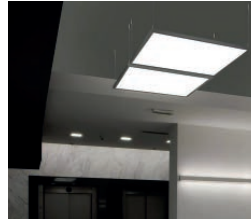

- Aluminum body
- Polypropylene screen
- Includes 1m hangers and driver

LED
LIGHT

LED PANEL, DAYLIGHT

Voltage	Frequency	Lifespan
110-220 V~	60 Hz	30,000 hr



NOM

Code	Watts	Lumens	Measurement	Thickness	#LEDS	Inner	Master
FU1346	36 W	2,500 lm	60 x 60 cm	1 cm	180	1	5
FU1347	48 W	3,400 lm	120 x 30 cm	1 cm	240	1	5
FU1348	72 W	5,000 lm	120 x 60 cm	1 cm	360	1	2

Type of packaging: Box



LED
LIGHT

LED
LIGHT



- Aluminum body



- Metal base and acrylic cover

NOM

NOM



BUILT-IN CEILING LED, DAYLIGHT

Voltage	Frequency	Lifespan
110-220 V~	60 Hz	30,000 hr

Code	Watts	Lumens	Exterior diam-Installation eter	Installation ameter	di-	#LEDS	Inner	Master
FU1242	6 W	300 lm	12 cm	11 cm		30	4	10
FU1243	12 W	750 lm	17 cm	16 cm		60	4	10
FU1244	18 W	1,100 lm	22 cm	21 cm		90	4	10

Type of packaging: Box

EXTERNALLY MOUNTED CEILING LED, DAYLIGHT

Voltage	Frequency	Lifespan
110-220 V~	60 Hz	30,000 hr

Code	Watts	Lumens	# of LEDS	Diameter	Inner	Master
FU1255	10 W	700 lm	52	26 cm	4	10
FU1256	15 W	1,050 lm	76	33 cm	4	10
FU1257	19 W	1,400 lm	105	38 cm	2	8

Type of packaging: Box



- Multicolor (red, green and blue)
- Includes remote control

FU1200



- Daylight 6,500 K

FU1199

LED
LIGHT

NOM



LED STRIP - 60 LEDs per meter - Includes self-adhesive strip along the entire tape - Adjustable size, can be cut every 5 cm

Voltage	Frequency
110-220 V~	60 Hz

Code	Product	Strip measurement	Watts	Inner	Master
FU1200	Multicolor LED strip	5 m x 10 mm	39.5 W	1	2
FU1199	Daylight LED strip	5 m x 8 mm	18.5 W	1	2

Packing type: FU1200 Blister / FU1199 Box





FU0168
 - Turns on automatically with the sunset
 - Switch not included



FU0268



FU0167



FU0429



FU0428



FU0166

NIGHT LIGHT

- Fabricada en plástico resistente al calor - Incandescent type - On/Off button - Frecuencia 60 Hz - 120 V-

Code	Product	Watts	Lifespan	Inner	Master
FU0168	Night light with photocell	4 W	1,200 hr	12	60
FU0268	Rectangular	4 W	1,200 hr	12	60
FU0167	Flower	4 W	1,200 hr	12	60
FU0429	Bear	4 W	1,200 hr	12	60
FU0428	Moon	4 W	1,200 hr	12	60
FU0166	Butterfly	4 W	1,200 hr	12	60

NOM



Type of packaging: Blister



FU0430



FU0425



FU0337



FU0324



FU0336



FU0335

NIGHT LIGHT

- Fabricada en plástico resistente al calor - Incandescent type - On/Off button - Frecuencia 60 Hz - 120 V-

Code	Product	Watts	Lifespan	Inner	Master
FU0430	Duck	4 W	1,200 hr	12	60
FU0425	Shell	4 W	1,200 hr	12	60
FU0337	Football	4 W	1,200 hr	12	60
FU0324	Baseball	4 W	1,200 hr	12	60
FU0336	Soccer	4 W	1,200 hr	12	60
FU0335	Basketball	4 W	1,200 hr	12	60

NOM



Type of packaging: Blister



FU0783



FU0782



FU0670



FU0671

LANTERN

- Made of aluminium. - Beveled clear glass - Base E-27 - For outdoors and gardens - Bulb not included

Code	Product	Type	Height	Maximum power	Voltage		Frequency	
					Inner	Master	120 V~	60 Hz
FU0783	White colonial wall lantern with back plate		45 cm	100 W	2	10		
FU0782	White colonial wall lantern with back plate		35 cm	100 W	2	10		
FU0670	White classic wall lantern, with back plate		35 cm	100 W	2	10		
FU0671	White classic wall lantern		35 cm	100 W	2	10		

NOM



Type of packaging: Box



FU0784



FU0781



FU0672



FU0673

LANTERN

- Made of aluminium. - Beveled clear glass - Base E-27 - For outdoors and gardens - Bulb not included

Code	Product	Type	Height	Maximum power	Voltage		Frequency	
					Inner	Master	120 V~	60 Hz
FU0784	Black colonial wall lantern, with back plate		45 cm	100 W	2	10		
FU0781	Black square wall lantern, with back plate		35 cm	100 W	2	10		
FU0672	Black classic wall lantern, with back plate		35 cm	100 W	2	10		
FU0673	Black classic wall lantern		35 cm	100 W	2	10		

NOM



Type of packaging: Box

LIGHTING | SUBURBAN LIGHTBULB | STREET LIGHTS



- Includes 1 daylight energy-efficient bulb, 85W (FU0693)
- Outdoor use

*Waterproof IP65

FU0710



- Polycarbonate Fixture
- Includes 1 big energy-efficient bulb, daylight 65W

*Waterproof IP20

FU1079



- Plastic fixture
- Includes 1 big energy-efficient spiral bulb, daylight 65W (FU0267)
- Outdoor use

*Waterproof IP25

FU0157

ENERGY EFFICIENT SUBURBAN STREET LIGHT WITH ALUMINIUM FIXTURE

- Diffuser acrylic diameter: 9" - Automatic photocell

Code	Characteristics	Type	Lumens	Maximum power	Maximum current	Inner	Master
FU0710	Aluminium fixture without arm	Energy-efficient	3,575	85 W	0.98 A	1	4
FU1079	Plastic fixture without arm	Energy-efficient	4,225	65 W	0.68 A	1	4
FU0157	Plastic fixture without arm	Energy-efficient	2,250	65 W	0.50 A	1	6

Type of packaging: Box

Base	Voltage	Frequency
E27	120 V~	60 Hz

NOM

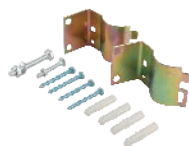

- Suburban type
- Cable length: 25 cm
- With photocell for automatic on and off

- Includes arm, clamp and screws
- Diffusing acrylic diameter: 10"
- For outdoor use

* Includes non-replaceable lamp

*Waterproof IP65



Dia, 6,500 K

NOM

50W LED SUBURBAN STREET LIGHT WITH ARM, DAYLIGHT

Code	Watts	Type	Lumens	Current	Inner	Master
FU1078	50 W	LED	4000	0.5 A	1	4

Type of packaging: Box

Voltage	Frequency	Lifespan
120 V~	60 Hz	20,000 hr

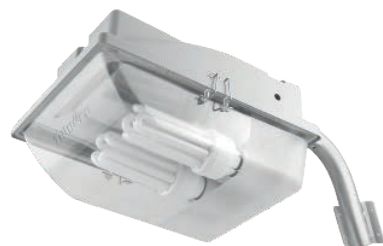

- Body made of ABS and acrylic screen
- With photocell for automatic on and off

- Includes arm, clamp and screws
- Includes 2 energy-efficient bulbs: 4 U 36 W, daylight
- For outdoor use

*Waterproof IP55

NOM

Base	Voltage	Frequency
E27	120 V~	60 Hz



ENERGY EFFICIENT SUBURBAN STREET LIGHT WITH ARM 2 X 36 W

Code	Type	Lumens	Maximum power	Maximum current	Inner	Master
FU1080	Energy-efficient	3,800	72 W	0.6 A	1	4

Type of packaging: Box



FU0422



FU0295

- FU0422: Compatible with photoelectric switch

- FU0295: Made of plastic
- Dual voltage

NOM



PHOTOCELL CONTACT

Code	Characteristics	Frequency	Inner	Master
FU0422	125 V~ 15 A	60 Hz	10	100
FU0295	120 V~ / 220 V~	50 - 60 Hz	5	50

Type of packaging: Box



FU0668



FU0669

- Base made of ABS
- Polycarbonate screen
- For exteriors and interiors
- Includes big energy-efficient bulb 3U daylight, 20 W (FU0024)

*Waterproof IP44

NOM

Socket	Voltage	Frequency
E27	120 V~	60 Hz



STREET LIGHT

Code	Product	Watts	Inner	Master
FU0668	Jelly-jar wall light	20 W	2	10
FU0669	Globe wall light	20 W	2	10

Type of packaging: Box



ELECTRICAL FIXTURES HABITAT LINE

- Made of Polycarbonate
- Screws included
- The switches, contacts and plate of the Habitat line are compatible only between them
- Voltage 120 V ~ 15A
- Frequency 60 Hz



FU1466



FU1465



FU1464



FU1462 / FU1463



FU1460 / FU1461



FU1458 / FU1459

NOM

PLATE

Code	Product	Inner	Master
FU1466	2 Grounded Contacts Plate	10	200
FU1465	Contact Landing Plate	10	200
FU1464	Simple switch plate + Grounded contact	10	200
FU1462	3 single switches plate	10	200
FU1463	2 Single switches plate + 3 Way switcher	10	200
FU1460	2 single switches plate	10	200
FU1461	Single switch plate + 3 way switcher	10	200
FU1458	Single switch plate	10	200
FU1459	3 way switch plate	10	200

Type of packaging: Bag



ELECTRICAL FIXTURES DECOR LINE



- Made in Polycarbonate
- Screws included
- The switches, contacts and plate of the DEOCR line are compatible only between them.
- Voltage 120 V ~ 15A
- Frequency 60 Hz



FU1327



FU1328
Max USB output is 2.1A



FU1326



FU1325



FU1324



FU1323 / FU1322

CONTACT



Code	Product	Characteristics	Inner	Master
FU1327	Double grounded contact GFCI with plastic plate	Brass terminals	4	50
FU1328	Single grounded contact + double USB	Brass terminals	4	200
FU1326	Double grounded contact	Brass terminals	20	200

SWITCH

FU1325	Triple switch	-	10	200
FU1324	Double switch	-	10	200
FU1323	3 way switch	-	20	200
FU1322	Single switch	-	20	200

Type of packaging: Bag



- "DECOR Line"
- Made of ABS
- Screws included

PLASTIC PLATE

Code	Characteristics	Inner	Master
FU1319	1 Window	80	640
FU1320	2 Window	60	480
FU1321	3 Window	40	320

Type of packaging: Bag





- "DECOR Line"
- Made of polycarbonate
- Dimmer and switch function
- Screws included



SINGLE POLE DIMMER

Code	Characteristics	Power	Inner	Master
FU1329	120 V - 60 Hz	600 W	2	100

Type of packaging: Bag

ELECTRICAL FIXTURES CLASSIC LINE



- Made of polycarbonate
- Screws included The switches, contacts and plates of the classic line are only compatible between them.
- Voltage 120 V ~ 15A

· Frequency 60 Hz



FU0900



FU1450



FU1451 / FU1452



FU1448 / FU1449



FU1446 / FU1447



FU1454



FU1455



FU1456



FU1457

NOM

PLATE

Code	Product	Composed of articles:	Inner	Master
FU0900	Plate Kit and 2 ground contacts	-	10	200
FU1450	Simple Plate Switch + Ground contact	FU0891 + FU0895 + FU0894	10	200
FU1451	3 single switches plate	FU0892 + FU0895	10	200
FU1452	2 Single switches plate + 3 Way switcher	FU0892 + FU0895 + FU0896	10	200
FU1448	2 Single plate switch	FU0891 + FU0895	10	200
FU1449	Single switch plate + 3 way switcher	FU0891 + FU0895 + FU0896	10	200
FU1446	Single switch plate	FU0890 + FU0895	10	200
FU1447	3 way switch plate	FU0890 + FU0896	10	200
FU1454	Door bell plate	FU0890 + FU0899	10	200
FU1455	TV connector plate	FU0890 + FU0897	10	200
FU1456	Telephone jack plate	FU0890 + FU0898	10	200
FU1457	Rotating Dimmer Plate	FU0890 + FU0911	10	200

Type of packaging: Bag



FU0894



FU0893



FU0899



FU0896



FU0895

CONTACT - Made in Polycarbonate The switches, contacts and plates of the classic line are only compatible between them. - Frecuencia 60 Hz

Code	Product	Characteristics	Inner	Master
FU0894	Grounded contact	120 V- 15 A	20	600
FU0893	Polarized contact	120 V- 15 A	20	600

Code	Product	Characteristics	Inner	Master
FU0899	Doorbell	120 V- 10 A	20	600
FU0896	3 way switch	120 V- 10 A	20	600
FU0895	Simple switch	120 V- 10 A	20	600

Type of packaging: Bag

NOM



FU0911

NOM



FU0898



FU0897

CONNECTOR - Made in Polycarbonate The switches, contacts and plates of the classic line are only compatible between them.

Code	Product	Specifications	Characteristics	Inner	Master
FU0911	Rotary Dimmer	120 V- 60 Hz 150 W	For dimmable bulbs	10	600
FU0898	Telephone Connector	-	4 lines	20	600
FU0897	TV Connector	70 Ohms	For TV, zinc connector	20	600

Type of packaging: Bag



FU0892



FU0891



FU0890

PLASTIC PLATE - Made of polycarbonate Includes screws

Code	Characteristics	Inner	Master
FU0892	3 Window	20	480
FU0891	2 Window	20	480
FU0890	1 window	20	480

Type of packaging: Bag

ELECTRICAL FIXTURES ITALIAN LINE PLATES



- Made of aluminium.
- Plastic chassis
- Screws included

- Voltage 120 V ~ 15A
- Frequency 60 Hz



FU1445



FU1442



FU1443



FU1444



FU1441

NOM

PLATE

Code	Product	Composed of articles:	Inner	Master
FU1445	2 simple contact plate	FU0764 + FU0702	10	200
FU1442	Simple contact plate	FU0763 + FU0702	10	200
FU1443	Simple switch plate + Simple Contact	FU0764 + FU0702 + FU0699	10	200
FU1444	2 single switches plate	FU0892 + FU0895	10	200
FU1441	Single switch plate	FU0763 + FU0699	10	200

Type of packaging: Bag



FU0765



FU0764



FU0763



FU0143

ALUMINUM PLATE

- Made of aluminium - Plastic chassis - Includes screws - For Italian type switches - Thickness: 0.8mm

Code	Product	Inner	Master
FU0765	3 Windows aluminum plate	30	300
FU0764	2 Windows aluminum plate	30	300
FU0763	1 Window aluminum plate	30	300
FU0143	Blank aluminum plate	30	300

Type of packaging: Bag



FU0702



FU0699



FU0701

CONTACT AND SWITCH

- - Made of bakelite - Frecuencia 60 Hz

Code	Product	Characteristics	Inner	Master
FU0702	Simple contact	120 V~ 15 A	50	500
FU0699	Single switch	120 V~ 10 A	50	500
FU0701	Toggle switch	120 V~ 10 A	50	5

Type of packaging: Bulk

NOM



FU0698



FU0718

FLOURESCENT SWITCH

- - Made of bakelite - Fluorescent button - Frecuencia 60 Hz

Code	Product	Characteristics	Inner	Master
FU0698	Flourescent single switch	120 V~ 10 A	50	500
FU0718	Flourescent toggle switch	120 V~ 10 A	50	500

Type of packaging: Bulk

NOM



FU0144



FU0143



FU0141



FU0142



FU0153

ALUMINUM PLATE

Includes screws

Code	Product	Use	Thickness	Inner	Master
FU0144	Pilot plate	For cable connections	0.8 mm	30	300
FU0143	Blank plate	Rectangular Switch Box	0.8 mm	30	300
FU0141	Duplex contact plate	For contacts and duplex switches	0.8mm	30	300
FU0142	Simple contact plate	For simple contacts	0.8 mm	30	300
FU0153	Vertical lever plate	For lever switch	0.8mm	30	300

Type of packaging: Bag



FU0148



FU0152

PLASTIC PLATE

Includes screws

Code	Product	Use	Inner	Master
FU0148	Blank plate	Rectangular Switch Box	30	300
FU0152	Vertical lever plate	For lever switch	30	300

Type of packaging: Bag



FU0149



FU0151



FU0154 / FP0046



FU01621

PLASTIC PLATE

Includes screws

Code	Product	Use	Inner	Master
FU0149	Pilot plate	For cable connections	30	300
FU0151	Single toggle plate	For single outlets	30	300
FU0154	Duplex contact plate	For contacts and duplex switches	30	300
FP0046	Duplex contact plate	For contacts and duplex switches	50	400
FU01621	Hospital duplex plate (1.05 mm)	For contacts and duplex switches	30	300

Type of packaging: Bag





FU1626



FU1627

· Centered hole



FU1628

· Hole on one side

METAL PLATE (STEEL)

Includes screws

Code	Product	Use	Thickness	Inner	Master
FU1626	Simple contact plate	For simple contacts	0.8 mm	30	300
FU1627	Single contact plate duplex box	For single outlets	0.8 mm	30	300
FU1628	Single contact plate duplex box	For single outlets	0.8 mm	30	300

Type of packaging: Bag



FU1625



FU1623



FU1622



FU1624

METAL PLATE (STEEL)

Includes screws

Code	Product	Use	Thickness	Inner	Master
FU1625	Simple contact plate	For simple contacts	0.8 mm	30	300
FU1623	Duplex contact plate	For contacts and duplex switches	0.8 mm	30	300
FU1622	Vertical lever plate	For lever switch	0.8 mm	30	300
FU1624	Blank plate	Rectangular Switch Box	0.8 mm	30	300

Type of packaging: Bag



FU0395



FU0155



FP0041

WEATHER RESISTANT PLASTIC PLATE

Variable weather resistant

Code	Product	Use	Inner	Master
FU0395	Weather resistant single plate	For single contacts	10	60
FU0155	Weather resistant duplex plate	For duplex contacts	10	60
FP0041	Weather resistant duplex plate	For duplex contacts	15	300

Type of packaging: FU Bag / FP Granel





FU1614



FU1615



FU1616

CONTACT Made of polycarbonate Includes screws - Frequency 60 Hz

Code	Product	Characteristics	Inner	Master
FU1614	Duplex contact	120 V- 20 A	20	200
FU1615	Duplex contact	250 V- 20 A	20	200
FU1616	Single contact	120 V/ 220- 20 A	10	200

Type of packaging: Bag

NOM



FU0283



FU0094



FU0093



FU1617

CONTACT Made of polycarbonate - Includes screws (FU0283) - Frequency 60 Hz

Code	Product	Type of connection	Characteristics	Inner	Master
FU0283	Simple mixed contact	Metal pressure terminals	120 V- 20 A	20	200
FU0094	Simple grounded contact	Metal pressure terminals	120 V- 15 A	20	200
FU0093	Double outlet	With screws and with pressure terminals	250 V- 15 A	20	200
FU1617	Double outlet	With screws and with pressure terminals	220 V- 20 A	20	200

Type of packaging: Bag

NOM



FU0431 / FU0090 / FP0029



FU0092



FU1618



FU1619

CONTACT Includes screws - Frequency 60 Hz

Code	Product	Type of connection	Characteristics	Inner	Master
FU0431	Duplex contact 10 pcs	With screws and with pressure terminals	120 V- 15 A	2	20
FU0090	Duplex contact	With screws and with pressure terminals	120 V- 15 A	20	200
FP0029	Duplex contact	With screws and with pressure terminals	120 V- 15 A	20	400
FU0092	Double contact	With screws and with pressure terminals	250 V- 15 A	20	200
FU1618	Duplex hospital contact	With screws	120 V- 15 A	10	200
FU1619	Duplex hospital contact	With screws	120 V- 20 A	10	200

Packing type: FU Bag / FP0029 Bulk / FU0431 Box

NOM



ELECTRICAL APPLIANCES | CONTACTS | SWITCH



FU0401 / FP0034



FU0122



FU0129



FU0359



FU0130

SWITCH

- Includes screws (FU0401, FP0034, FU0122 y FU0129) - Frequency 60 Hz

Code	Product	Material	Characteristics	Inner	Master
FU0401	Grounded combination switch	Bakelite	120 V~ 15 A	15	150
FP0034	Grounded combination switch	Bakelite	120 V~ 15 A	20	200
FU0122	Polarized combination switch	Bakelite	120 V~ 15 A	15	150
FU0129	Double lever switch	Bakelite	120 V~ 15 A	15	150
FU0359	Vertical single switch	Polycarbonate	120 V~ 15 A	20	200
FU0130	Vertical single switch	Polycarbonate	120 V~ 15 A	25	250

Type of packaging: FU Bag / FP Granel

NOM



FU0408 / FP0044



FU0100 / FP0026



FU0096



FU0095



FU1620

CONTACT

- Includes base and screws (FU0096) - Includes screws (FU0095) - Frequency 60 Hz

Code	Product	Material	Characteristics	Inner	Master
FU0408	Polarized surface duplex contact	ABS	120 V~ 15 A	20	200
FP0044	Polarized surface duplex contact	ABS	120 V~ 15 A	20	200
FU0100	Grounded surface duplex contact	ABS	120 V~ 15 A	20	200
FP0026	Grounded surface duplex contact	ABS	120 V~ 15 A	20	200
FU0096	Flat visible single receptacle	ABS	120 V~ 6 A	20	400
FU0095	Oval visible single receptacle	PVC	120 V~ 6 A	20	300
FU1620	Grounded surface duplex contact	Polycarbonate	120 V~ 15 A	20	200

Type of packaging: FU Bag / FP Granel

NOM



FU0123 / FP0042



FU0125



FU0124



FU0126

SWITCH

- Made of ABS - Includes base and screws - Frequency 60 Hz

Code	Product	Characteristics	Inner	Master
FU0123	Oval visible single switch	120 V~ 6 A	30	300
FP0042	Oval visible single switch	120 V~ 15 A	30	300
FU0125	Visible single switch	120 V~ 6 A	30	300
FU0124	Flat visible single switch	120 V~ 6 A	40	240
FU0126	Visible single switch	120 V~ 6 A	40	240

Type of packaging: FU Bag / FP Granel

NOM



ELECTRICAL FIXTURES LAMPHOLDER



- Aluminum lamp holder
- E27 Base
- Frequency 60 Hz



FU0419



FU0080



FU0081



FU0079 / FP0028



FU0082

LAMP HOLDER

Code	Product	Material	Voltage	Inner	Master
FU0419	Turn-knob lamp holder	Bakelite	250 V~ 250 W	20	200
FU0080	Push-botton lamp holder	Bakelite	250 V~ 250 W	20	200
FU0081	Pull-chain lamp holder	Bakelite	200 V~ 250 W	20	200
FU0079	Simple lamp holder	PVC	125 V~ 4 A	20	200
FP0028	Simple lamp holder	PVC	125 V~ 4 A	20	400
FU0082	Two-socket lamp holder	Bakelite	250 V~ 660 W	15	150

Type of packaging: FU Bag / [FP Granel](#)



FU0075 / FP0025



FU0078



FU0077 / FP0031



FU0076

TWO OUTLET LAMP HOLDER

- Made of bakelite - Aluminum thread 2 polarized contacts - E27 Base - Frequency 60 Hz

Code	Product	Characteristics	Inner	Master
*FU0075	Pull-chain lamp holder	120 V~ 660 W	20	200
*FP0025	Pull-chain lamp holder 120 V~ 660 W		50	400
FU0078	Pull-chain lamp holder	120 V~ 660 W	20	200
FU0077	Two outlet lamp holder	120 V~ 660 W	20	200
FP0031	Two outlet lamp holder	120 V~ 660 W	50	400
FU0076	Two outlet lamp holder	120 V~ 660 W	20	200

Type of packaging: FU Bag / [FP Granel](#)





FU0287



FU0420



FU0286

LAMP HOLDER

- Made of aluminium - Aluminum thread - E27 Base - Frecuencia 60 Hz

Code	Product	Characteristics	Inner	Master
FU0287	Pull-chain lamp holder	250 V~ 250 W	20	200
FU0420	Turn-knob lamp holder	250 V~ 250 W	20	200
FU0286	Push-botton lamp holder	250 V~ 660 W	20	200

Type of packaging: Bag

NOM



FU0407



FU0406



FU0070 / FU0071



FU0265



FP0027

ROUND LAMP HOLDER

- Aluminum thread (copper FP0027) - E27 Base - Frequency 60 Hz

Code	Product	Measurement	Material	Characteristics	Inner	Master
FU0407	Ceiling lamp holder with chain and polarized contact	4"	Porcelain	250 V~ 660 W	6	60
FU0406	Ceiling lamp holder with chain	4"	Porcelain	250 V~ 660 W	6	60
FU0070	Round lamp holder	3"	Porcelain	250 V~ 660 W	10	80
FU0071	Round lamp holder	4"	Porcelain	250 V~ 660 W	10	80
FU0265	Round lamp holder	4"	Bakelite	250 V~ 660 W	20	200
*FP0027	Round lamp holder	4"	Porcelain	250 V~ 660 W	10	80

Type of packaging: FU Box / FP Granel

NOM



FU0073 / FP0038



FU0085 / FP0039



FU0072



FU0266



FU0404



FU0257

LAMP HOLDER

- Aluminum thread (FU0266 y FU0404 bakelite) - Frequency 60 Hz

Code	Product	Material	Base	Characteristics	Inner	Master
FU0073	Square base lamp holder	Porcelain	E27	250 V~ 660 W	20	200
FP0038	Square base lamp holder	Porcelain	E27	250 V~ 660 W	20	240
FU0085	Mini lamp holder	Porcelain	E12	250 V~ 660 W	20	400
FP0039	Mini lamp holder	Porcelain	E12	250 V~ 660 W	50	500
FU0072	Mini-base lamp holder	Porcelain	E26	250 V~ 660 W	20	200
FU0266	Lamp holder adapter	Bakelite	E27	120 V~ 660 W	20	400
FU0404	Lamp holder adapter	Bakelite	E27	120 V~ 660 W	20	400
FU0257	Lamp holder to outlet adapter	PVC	E27	120 V~ 15 A	40	400

Type of packaging: FU Bag / FP Granel

NOM





FU0316



FU0086



FP0030



FU0088



FU0089



FU0087

LAMP HOLDER - Aluminum lamp holder - Frequency 60 Hz

Code	Product	Material	Cable measurements	Base	Characteristics	Inner	Master
FU0316	Weatherproof lamp holder with cables	Aluminum / Porcelain lamp holder	15 cm	E27	250 V~ 150 W	10	60
FU0086	Reinforced weatherproof rubber lamp holder with cables	Rubber	12 cm	E27	200 V~ 660 W	20	200
FP0030	Weatherproof rubber lamp holder with cables	Rubber	12 cm	E27	200 V~ 660 W	20	400
FU0088	Square base Lamp holder with cables	Porcelain	15 cm	E27	250 V~ 660 W	20	200
FU0089	Niple support for mini base lamp holder with cables	Porcelain	15 cm	E27	250 V~ 660 W	20	200
FU0087	Mogul base lamp holder	Porcelain	-	E39	600V~ 1500W	10	100

Type of packaging: FU Bag / FP Granel

NOM



FU1358

- For T8 LED fluorescent tube
- Maximum power: 660 W



FU0405

- "American type"
- Male and female
- Installation with screws
- Maximum power: 660 W



FU0236 / FU0237

- Plastic capsule protected with neon blinker

LAMP HOLDER - Frequency 60 Hz

Code	Product	Material	Base	Characteristics	Inner	Master
FU1358	Lamp holder	PBT Plastic	G13	600 V~	20	200
FU0405	Slimline lamp holder with spring	Bakelite	-	Male 1000 V~ / Female 600 V~	10	100
FU0236	Flourescent lamp starte	Plastic	-	FS-2 / 20 W / 120 V~	100	2000
FU0237	Flourescent lamp starte	Plastic	-	FS-4 / 40 W / 120 V~	100	2000

Type of packaging: Bag / Box FU0236 and FU0237

NOM



FU0288



FU0289



FU0291

WEATHER RESISTANT CIRCULAR LAMP HOLDER COVER - Made of aluminium Includes screws and packaging

Code	Product	Inner	Master
FU0288	Weather resistant circular lamp holder cover, 1 Outlet hole	10	120
FU0289	Weather resistant circular lamp holder cover, 2 Outlet hole	10	120
FU0291	Weather resistant circular lamp holder cover, 3 Outlet hole	10	120

Type of packaging: Shrinkable





FU0712

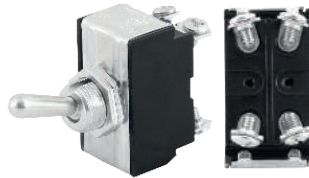

FU0412

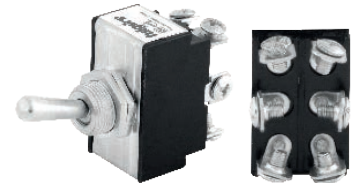

FU1636



FU0128



FU0411

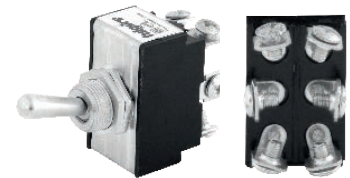

FU0413

LEVER SWITCH

- Bakelite base - Brass switch - Frequency 60 Hz

Code	Product	Plate	Characteristics	Inner	Master
FU0712	Lever switch, 2 screws	2 positions	120 V~ 15 A	20	400
FU0412	Lever switch, 4 screws	2 positions	120 V~ 15 A	20	400
FU1636	Lever switch, 6 screws	2 positions	120 V~ 15 A / 250 V~ 10 A	20	400
FU0128	Lever switch	2 positions	120 V~ 6 A	20	400
FU0411	Lever switch, 3 screws	3 positions	120 V~ 15 A	20	400
FU0413	Lever switch, 6 screws	3 positions	120 V~ 15 A	20	400

Type of packaging: Bag

NOM



FU0274



FU1637



FU1638



FU1639



FU0343



FU0277

SWITCH

- Frecuencia 60 Hz

Code	Product	Material	Characteristics	Inner	Master
FU0274	2 position chain switch	ABS	250 V~ 3 A	20	400
FU1637	2 position chain switch	ABS	125 V~ 6 A / 250 V~ 3 A	20	400
FU1638	2 position knob switch	Plastic	125 V~ 6 A / 250 V~ 3 A	10	400
FU1639	2 position knob switch	Metallic	125 V~ 6 A / 250 V~ 3 A	10	400
FU0343	Push-button mechanism switch	ABS	120 V~ 3 A	50	300
FU0277	Push-button switch	ABS	120 V~ 3 A	40	400

Type of packaging: Bag

NOM





FU1583



FU1584



FU1589



FU1594

Industrial Use

TWIST LOCK PLUG AND SAFETY CONTACT

- Frecuencia 60 Hz

Code	Characteristics	Material	Inner	Master
FU1583	250 V~ 20 A	Bakelite	5	200
FU1584	250 V~ 20 A	Rubber	5	100
FU1589	250 V~ 20 A	Nylon	3	100
FU1594	250 V~ 20 A	Nylon	3	200

Type of packaging: Bag

NOM



FU1590 / FU1591 / FU1592



FU1585 / FU1586 / FU1587



FU1595 / FU1596 / FU1597

Industrial Use

TWIST LOCK PLUG AND SAFETY CONTACT, 3 POLES

- Made of nylon - Industrial use - Frequency 60 Hz

Code	Characteristics	Inner	Master
FU1590	120 V~ 15 A	3	200
FU1585	120 V~ 15 A	5	200
FU1595	120 V~ 15 A	3	200
FU1591	250 V~ 15 A	3	200
FU1586	250 V~ 15 A	5	200
FU1596	250 V~ 15 A	3	200
FU1592	277 V~ 15 A	3	200
FU1587	277 V~ 15 A	5	200
FU1597	277 V~ 15 A	3	200

Type of packaging: Bag / FU1595 Bulk

NOM



FU1593



FU1588



FU1598

Industrial Use

TWIST LOCK PLUG AND SAFETY CONTACT, 4 POLES

- Made of nylon - Industrial use - Frequency 60 Hz

Code	Characteristics	Inner	Master
FU1593	120-250 V~ 20 A	3	100
FU1588	120-250 V~ 20 A	3	100
FU1598	120-250 V~ 20 A	3	100

Type of packaging: Bag

NOM



ELECTRICAL APPLIANCES | PEGS | CONTACTS



FU0115



FU0293



FU0114 / FP0032



FU0105 / FP0045



FU0118 / FP0036



FU0711



GROUNDING ARMORED PLUG AND CONTACT

- Made of ABS - Frequency 60 Hz

Code	Product	Characteristics	Inner	Master
FU0115	Armored Plug and Connector with clamp	250 V~ 15 A	25	400
FU0293	Armored Plug and Connector with clamp	250 V ~ 15 A	20	200
FU0114	Grounded armored plug	120 V~ 15 A	25	400
FU0105	Grounded armored contact	120 V~ 15 A	20	200
FP0032	Grounded armored plug	120 V~ 15 A	25	500
FP0045	Grounded armored contact	120 V~ 15 A	25	500
FU0118	Armored plug	120 V~ 15 A	25	400
FU0711	Armored contact	120 V ~ 15 A	20	200
FP0036	Armored plug	120 V~ 15 A	50	500

Type of packaging: FU Bag / [FP Granel](#)

NOM



FU1137



FU1142



FU0415



FU0414



FU0417



FU0416



PLASTIC GROUNDING ARMORED PLUG AND CONNECTOR

- Made of ABS - Frecuencia 60 Hz

Code	Product	Characteristics	Inner	Master
FU1137	Armored Plug and Connector with clamp	120 V~ 15 A	20	200
FU1142	Armored Plug and Connector with clamp	120 V ~ 15 A	20	200
FU0415	Grounded armored plug	120 V~ 15 A	20	200
FU0414	Grounded armored contact	120 V ~ 15 A	20	200
FU0417	Armored plug	120 V~ 15 A	20	200
FU0416	Armored contact	120 V ~ 15 A	20	200

Type of packaging: Bag

NOM



FU1139



FU1141



FU1138



FU1140



FU0112 / FP0043



FU1472

REINFORCED PLUG AND CONTACT WITH METALLIC CLAMP

- Made of ABS - Frecuencia 60 Hz

Code	Product	Characteristics	Inner	Master
FU1139	Grounded armored plug	120 V~ 15 A	25	400
FU1141	Grounded armored plug	120 V ~ 15 A	20	200
FU1138	Grounded armored reinforced plug	120 V~ 15 A	25	400
FU1140	Grounded reinforced contact	120 V ~ 15 A	20	200
FU0112	Reinforced Plug with clamp	120 V~ 15 A	25	400
FU1472	Reinforced contact with clamp	120 V~ 15 A	20	200
FP0043	Reinforced Plug with clamp	120 V~ 15 A	25	500

Type of packaging: FU Bag / [FP Granel](#)

NOM





FU0418



FP0035



FU0111 / FP0040

PLUG - Frequency 60 Hz

Code	Product	Material	Characteristics	Inner	Master
FU0418	Armored plug	Steel	120 V~ 15 A	25	200
FP0035	Armored plug	Steel	120 V~ 15 A	25	300
FU0111	Round rubber plug	Polycarbonate	120 V~ 15 A	50	400
FP0040	Round rubber plug	Polycarbonate	120 V~ 15 A	50	400

Type of packaging: FU Bag / FP Granel



FU0421



FU0103



FP0033

RUBBER PLUG AND CONNECTOR - Made of rubber - Frecuencia 60 Hz

Code	Product	Characteristics	Inner	Master
FU0421	Plastic plug	120 V~ 15 A	25	200
FU0103	Plastic contact	120 V~ 15 A	25	500
FP0033	Plastic plug	120 V~ 15 A	50	500

Type of packaging: FU Bag / FP Granel



FU0313



FU0314



FU0109



FU0385



FU0386



FU0384

PLASTIC PLUG - Made of rubber - Frecuencia 60 Hz

Code	Product	Color	Characteristics	Inner	Master
FU0313	Plastic plug	Brown	120 V~ 15 A	50	1000
FU0314	Plastic plug	Ivory	120 V~ 15 A	50	1000
FU0109	Plastic plug	Black	120 V~ 15 A	50	1000
FU0385	Oval rubber plug	Brown	120 V~ 10 A	50	1000
FU0386	Oval rubber plug	Ivory	120 V~ 10 A	50	1000
FU0384	Oval rubber plug	Black	120 V~ 10 A	50	1000

Type of packaging: Bag



FU0402



FU0403



FU0106



FP0037



FU0107

PLUG CONVERTER - Frecuencia 60 Hz

Code	Product	Material	Characteristics	Inner	Master
FU0402	Flat plug converter	Polycarbonate	120 V~ 15 A	25	1000
FU0403	Round plug converter	Polycarbonate	120 V~ 15 A	25	500
FU0106	Grounded plug converter	PVC	120 V ~ 15 A	50	500
FP0037	Grounded plug converter	Thermoplastic	120 V~ 15 A	100	1000
FU0107	Grounded plug converter	ABS	120 V~ 15 A	40	400

Type of packaging: FU Bag / FP Granel



ELECTRICAL FIXTURES FLEXIBLE TUBES

- Made of galvanized steel
- Thickness: 0.22 mm



PVC COATED FLEXIBLE TUBING FLEXIBLE TUBE

Code	Diameter	Length	Weight x meter	Weight x roll	Inner	Master
FU1418	3/8"	50 m	158 g	7.90 kg	1	1
FU1419	1/2"	50 m	172 g	8.60 kg	1	1
FU1420	3/4"	50 m	233 g	11.65 kg	1	1
FU1421	1"	50 m	346 g	17.30 kg	1	1
FU1422	1 1/4"	30 m	469 G	14.07 kg	1	1
FU1423	1 1/2"	30 m	793 g	23.79 kg	1	1
FU1424	2"	30 m	1031 g	30.93 kg	1	1

WEATHER RESISTANT PVC COATED

Code	Diameter	Length	Weight x meter	Weight x roll	Inner	Master
FU1425	3/8"	50 m	120 g	6.00 kg	1	1
FU1426	1/2"	50 m	130 g	6.50 kg	1	1
FU1427	3/4"	50 m	168 g	8.40 kg	1	1
FU1428	1"	50 m	256 g	12.80 kg	1	1
FU1429	1 1/4"	30 m	330 G	9.90 kg	1	1
FU1430	1 1/2"	30 m	585 g	17.55 kg	1	1
FU1431	2"	30 m	753 g	22.59 kg	1	1

Type of packaging: Roll



FU0465



FU0348



FU0745
Light model

ENTRANCE HEADS

- Made of aluminium - With 1 1/4" (31.75 mm) - For wiring and connection installations

Code	Product	Inner	Master
FU0465	Reinforced service entrance head with threaded connection	10	100
FU0348	Reinforced service entrance head with clamp	10	100
FU0745	Service entrance with threaded connection	35	210

Type of packaging: Bulk



EMT FOR ELBOW

- Made of steel - Galvanized finish

Code	Measurement	Thickness	Weigth	Inner	Master
FU1517	1/2"	1 mm	76 g	10	50
FU1518	3/4"	1 mm	129 g	10	50
FU1519	1"	1 mm	243 g	10	20
FU1520	1 1/4"	1.5 mm	477 g	5	20
FU1521	1 1/2"	1.5 mm	621 g	5	10
FU1522	2"	1.5 mm	1030 g	10	10

Type of packaging: Bulk



LIQUID TIGHT STRAIGHT CONNECTOR

- Made in zamac

Code	Measurement	Weigth	Inner	Master
FU1571	1/2"	48 g	10	250
FU1572	3/4"	70 g	10	200
FU1573	1"	125 g	10	100
FU1574	1 1/4"	220 g	10	50
FU1575	1 1/2"	240 g	10	50
FU1576	2"	286 g	10	50

Type of packaging: Bulk



LIQUID TIGHT CURVED CONNECTOR

- Made in zamac

Code	Measurement	Weigth	Inner	Master
FU1577	1/2"	76 g	10	250
FU1578	3/4"	110 g	10	100
FU1579	1"	170 g	10	100
FU1580	1 1/4"	300 g	10	50
FU1581	1 1/2"	360 g	10	50
FU1582	2"	500 g	10	20

Type of packaging: Bulk



STRAIGHT CONNECTOR FOR FLEXIBLE TUBE

- Made in zamac - Includes locknut

Code	Measurement	Thickness	Internal diameter	External diameter	Weigth	Inner	Master
FU1535	3/8"	1.2 mm	9.5 mm	20 mm	18.7 g	10	500
FU0062	1/2"	1.2 mm	15 mm	20 mm	26.4 g	10	200
FU0063	3/4"	1.2 mm	22 mm	25.5 mm	33.2 g	10	100
FU0064	1"	1.5 mm	25.6 mm	32 mm	68.8 g	10	100
FU1536	1 1/4"	1.5 mm	34 mm	41 mm	89.9 g	10	100
FU1537	1 1/2"	1.8 mm	39.8 mm	46.8 mm	130.9 g	10	60
FU1538	2"	1.8 mm	51.6 mm	58.6 mm	172.1 g	10	40

Type of packaging: Bulk



CURVED METAL FLEXIBLE CONDUIT CONNECTOR

- Made in zamac - Includes locknut

Code	Measurement	Thickness	Internal diameter	External diameter	Weigth	Inner	Master
FU1539	3/8"	0.8 mm	9.5 mm	20 mm	35 g	10	200
FU0065	1/2"	0.8 mm	15 mm	20 mm	51.6 g	10	200
FU0066	3/4"	1.1 mm	22 mm	25.4 mm	70.3 g	10	100
FU0067	1"	1.1 mm	25.6 mm	32 mm	119.7 g	10	100

Type of packaging: Bulk



STRAIGHT CABLE CONNECTOR

- Made in zamac - Includes locknut

Code	Measurement	Thickness	Internal diameter	External diameter	Weigth	Inner	Master
FU1540	3/8"	0.8 mm	15.8 mm	20 mm	17 g	10	1000
FU1541	1/2"	0.8 mm	15.8 mm	20 mm	17 g	10	1000
FU1542	3/4"	0.8 mm	21 mm	25.4 mm	32.3 g	10	500
FU1543	1"	1 mm	27 mm	32 mm	48 g	10	250

Type of packaging: Bulk



LOCKNUT

- Made in zamac

Code	Measurement	Thickness	Internal diameter	External diameter	Weigth	Inner	Master
FU1529	1/2"	3 mm	19 mm	25 mm	3.2 g	20	1000
FU1530	3/4"	3.3 mm	25.5 mm	30.5 mm	4.2 g	20	1000
FU1531	1"	4.3 mm	30.9 mm	39 mm	8.4 g	20	1000
FU1532	1 1/4"	4 mm	40 mm	50 mm	9.9 g	20	1000
FU1533	1 1/2"	4.5 mm	45 mm	55 mm	16.9 g	20	1000
FU1534	2"	5 mm	57 mm	69 mm	29.3 g	20	1000

Type of packaging: Bulk



THREADED MONITOR

- Made in zamac

Code	Measurement	Internal diameter	External diameter	Weigth	Inner	Master
FU1523	1/2"	16MM	25.5 mm	6.4 g	25	2000
FU1524	3/4"	19 mm	31 mm	8.6 g	25	1000
FU1525	1"	26.8 mm	39.4 mm	13.5 g	25	400
FU1526	1 1/4"	34.5 mm	47.3 mm	23.4 g	25	320
FU1527	1 1/2"	40.4 mm	53.5 mm	23.5 g	25	200
FU1528	2"	52 mm	66.3 mm	45.5 g	25	200

Type of packaging: Bulk



RIGID TUBE COUPLER

- Made of steel - Galvanized finish

Code	Measurement	Thickness	Internal diameter	External diameter	Weigth	Inner	Master
FU1544	1/2"	2 mm	20 MM	24 mm	32 g	20	500
FU1545	3/4"	2 mm	25 mm	29 mm	37.8 g	20	250
FU1546	1"	2 mm	31 mm	35 mm	51.4 g	20	200
FU1547	1 1/4"	2.5 mm	40 mm	45 mm	104.4 g	20	150
FU1548	1 1/2"	2.6 mm	45.5 mm	50.6 mm	110.1 g	20	120
FU1549	2"	2.5 mm	58 mm	63 mm	141.4 g	20	80

Type of packaging: Bulk



CED-40 TUBE COUPLER

- Made of steel - Galvanized finish

Code	Measurement	Thickness	Internal diameter	External diameter	Weigth	Inner	Master
FU1550	1/2"	3.5 mm	20 MM	26 mm	60 g	20	200
FU1551	3/4"	3.5 mm	25 mm	32 mm	81.7 g	20	100
FU1552	1"	3.7 mm	31.8 mm	39 mm	125.2 g	20	50
FU1553	1 1/4"	4 mm	40 mm	48 mm	187.2 g	20	50
FU1554	1 1/2"	4 mm	46 mm	54 mm	204.3 g	20	50
FU1555	2"	4.5 mm	58 mm	67 mm	317.8 g	20	40

Type of packaging: Bulk



ALUMINUM REDUCTION

- Made of aluminium.

Code	Measure (reduction)	Weigth	Inner	Master
FU1556	3/4" a 1/2"	6.4 g	25	1000
FU1557	1" a 1/2"	18.6 g	25	600
FU1558	1" a 3/4"	10.8 g	25	600
FU1559	1 1/4" a 1/4"	40.5 g	25	400
FU1560	1 1/4" a 1/4"	32.1 g	25	400
FU1561	1 1/4" a 1/4"	19.5 g	25	400
FU1562	1 1/2" A 1/2"	60.1 G	25	300
FU1563	1 1/2" a 3/4"	52.6 g	25	300
FU1564	1 1/2" a 1/2"	40.1 g	25	300
FU1565	1 1/2" a 1 1/4"	35.6 g	25	300
FU1566	2" a 1/2"	119.8 g	25	200
FU1567	2" a 3/4"	111.2 g	25	200
FU1568	2" a 1"	96.4 g	25	200
FU1569	2" a 1 1/4"	91.9 g	25	200
FU1570	2" a 1 1/2"	44.5 g	25	200

Type of packaging: Bulk



ONE-CHANNEL CLAMP

- Made of steel - Galvanized finish

Code	Measurement	Thickness	Weigth	Inner	Master
FU1493	1/2"	1.5 mm	49.7 g	50	250
FU1494	3/4"	1.5 mm	52.6 g	50	250
FU1495	1"	1.5 mm	62.4 g	50	250
FU1496	1 1/4"	1.5 mm	73.8 g	50	300
FU1497	1 1/2"	1.5 mm	78.1 g	20	240
FU1498	2"	1.5 mm	91.1 g	20	200
FU1499	2 1/2"	1.8 mm	119.3 g	20	140
FU1500	3"	1.8 mm	141.1 g	20	140
FU1501	4"	1.8 mm	167.7 g	20	100

Type of packaging: Bulk



"U" TYPE CLAMP

- Made of steel - Galvanized finish

Code	Measurement	Inner	Master
FU1502	1/2"	50	500
FU1503	3/4"	50	500
FU1504	1"	50	500
FU1505	1 1/4"	50	500
FU1506	1 1/2"	50	500
FU1507	2"	50	500
FU1508	2 1/2"	25	100
FU1509	3"	25	100
FU1510	4"	25	100

Type of packaging: Bulk



CONDUIT STRAP OMEGA TYPE

- Made of steel - Matte finish

Code	Measurement	Thickness	Inner	Master
FU0251	1/2"	1 mm	350	1400
FU0252	3/4"	1 mm	200	800
FU0253	1"	1.2 mm	150	600
FU0365	1 1/4"	1.2 mm	50	200
FU0366	1 1/2"	1.5 mm	35	140
FU0367	2"	1.5 mm	25	100

Type of packaging: Bulk



1-HOLE CONDUIT CLAMP

- Made of steel - Matte finish

Code	Measurement	Thickness	Inner	Master
FU0248	1/2"	1 mm	500	2000
FU0249	3/4"	1 mm	250	1000
FU0250	1"	1.2 mm	250	1000
FU0362	1 1/4"	1.2 mm	75	300
FU0363	1 1/2"	1.5 mm	50	200
FU0364	2"	1.5 mm	50	200

Type of packaging: Bulk



"O" TYPE CLAMP

- Made of steel - Galvanized finish

Code	Measurement	Thickness	Weigth	Inner	Master
FU1511	1/2"	1.5 mm	27.5 g	25	500
FU1512	3/4"	1.5 mm	30.9 g	25	400
FU1513	1"	1.5 mm	34.4 g	25	200
FU1514	1 1/4"	1.5 mm	49.6 g	25	200
FU1515	1 1/2"	1.5 mm	55.2 g	20	160
FU1516	2"	1.5 mm	62.5 g	20	80

Type of packaging: Bulk



FU0247 / FU0868



FU0245 / FU0246
FU0869 / FU0867



FU0244 / FU0866

BOX - Made from galvanized steel

Code	Product	Measurement	Entry	Thickness	Inner	Master
FU0247	Square box	4" x 4"	1/2" y 3/4"	0.76 mm	50	50
FU0868	Reinforced square box	4" x 4"	1/2" y 3/4"	1 mm	24	24
FU0245	Hex box	3" x 3"	1/2"	0.76 mm	50	50
FU0246	Hex box	4" x 4"	1/2" y 3/4"	0.76 mm	50	50
FU0869	Reinforced hex box	3" x 3"	1/2"	1 mm	24	24
FU0867	Reinforced hex box	4" x 4"	1/2" y 3/4"	1 mm	24	24
FU0244	Rectangular box	2" x 4"	1/2"	0.76 mm	50	50
FU0866	Reinforced rectangular box	2" x 4"	1/2"	1 mm	24	24

Type of packaging: Bulk



FU1629



FU1632

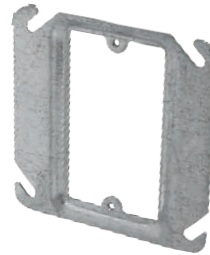

FU1630

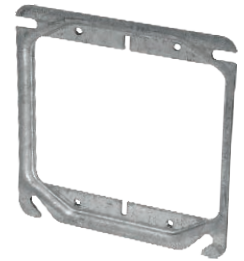

FU1631

COVER / FRAME - Made from galvanized steel

Code	Product	Measurement	Exit	Thickness	Inner	Master
FU1629	Square box cover	4" x 4"	1/2"	1 mm	25	200
FU1632	Hex box cover	4" x 4"	1/2"	1 mm	10	200
FU1630	Simple frame reduction	4" x 4"	-	1 mm	10	100
FU1631	Double frame reduction	4" x 4"	-	1 mm	10	100

Type of packaging: Bulk



FU1633



FU1634



FU1635

METALLIC BOX EXTENSION - Made from galvanized steel

Code	Product	Measurement	Exit	Depth	Thickness	Inner	Master
FU1633	Square box metallic extension	4" x 4"	8 1/2" / 4 3/4" exits	1 1/2"	1 mm	24	24
FU1634	Hex box metallic extension	4" x 4"	2 1/2" exits 2 3/4" exits	1 1/2"	1 mm	24	24
FU1635	Rectangular box metallic extension	4" x 4"	8 1/2" exits	1 3/4"	1 mm	24	24

Type of packaging: Bulk

ELECTRICAL APPLIANCES | CONDULET | HOSES



FU1476 / FU1477 / FU1478



FU1479 / FU1480 / FU1481



FU1482 / FU1483 / FU1484

CONDULET - Made of aluminium. - Threaded entry - Includes cover and packaging

Code	Product	Measurement	Inner	Master
FU1476	Condulet type LB	1/2"	10	120
FU1477	Condulet type LB	3/4"	10	90
FU1478	Condulet type LB	1"	10	60
FU1479	Condulet type LR	1/2"	10	120
FU1480	Condulet type LR	3/4"	10	90
FU1481	Condulet type LR	1"	10	60
FU1482	Condulet type LL	1/2"	10	120
FU1483	Condulet type LL	3/4"	10	90
FU1484	Condulet type LL	1"	10	60

Type of packaging: Shrinkable



FU1485 / FU1486 / FU1487



FU1488 / FU1489 / FU1490



FU1491 / FU1492

CONDULET - Made of aluminium. - Threaded entry - Includes cover and packing (Except FU1491 and FU1492)

Code	Product	Measurement	Inner	Master
FU1485	Condulet type T	1/2"	10	120
FU1486	Condulet type T	3/4"	10	75
FU1487	Condulet type T	1"	10	50
FU1488	Condulet type C	1/2"	10	120
FU1489	Condulet type C	3/4"	10	90
FU1490	Condulet type C	1"	10	60
FU1491	Condulet box Fs	1/2"	10	50
FU1492	Condulet box Fs	3/4"	10	50

Type of packaging: Shrinkable



- Resistance to temperature without deforming: 5°C to 60°C
- 20 calibre steel wire guide

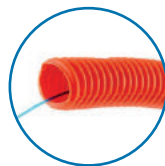

- Made of high density polyethylene
- To install built-in lights
- Electrical and anticorrosive insulation
- Maximum voltage: 1,000 VAC
- Maximum current: 65 A
- It has 8 inputs for flexible tube
- 2 de 1/2"
- 4 de 3/4"
- 2 de 1"

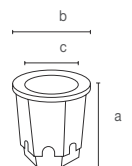

CORRUGATED FLEXIBLE PIPELINE

Code	Length	Diameter	Characteristics	Wall thickness	Inner	Master
FU0583	100 m	1/2"	Without guide	0.36 mm	1	1
FU0584	50 m	3/4"	Without guide	0.47 mm	1	1
FU0746	100 m	1/2"	With guide	0.36 mm	1	1
FU0747	50 m	3/4"	With guide	0.47 mm	1	1

Type of packaging: Roll

HEAT SINK

Code	Depth	External diameter (b)	Internal diameter (c)	Inner	Master
FU1409	9 cm	17 cm	11cm	10	90
FU1410	9 CM	17 cm	8CM	10	90
FU1407	12.5cm	17 cm	11cm	10	90
FU1408	12.5cm	17 cm	8CM	10	90

Type of packaging: Bulk



- For wall mounting
- Reinforced door
- Lock with key
- Temperature range: -20°C a 70°C
- For uses in electricity, keypads, telephony, control panels, contactors, etc.

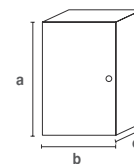

METALLIC CABINET

- Water protection: IP65

Code	Height (a)	Width (b)	Depth (c)	Inner	Master
FU1413	40 cm	30 cm	20 cm	1	1
FU1414	50 cm	40 cm	20 cm	1	1
FU1415	60 cm	40 cm	20 cm	1	1
FU1416	70 cm	50 cm	20 cm	1	1
FU1417	80 cm	60 cm	30 cm	1	1

Type of packaging: Box



FU1016



FU1018



FU1020



FU1401

BUILT-IN LOAD CENTER

- Made of steel sheet - Frecuencia 60 Hz

NOM

Code	# of poles	Phase	Characteristics	Maximum current	Inner	Master
FU1016	1	1	110-220 V~	70 A	10	10
FU1018	2	1	110-220 V~	70 A	10	10
FU1020	4	1	110-220 V~	70 A	6	6
FU1401	6	1	110-220 V~	70 A	1	6

Type of packaging: Bulk



FU1017



FU1019



FU1021



FU1402

BUILT-IN LOAD CENTER

- Made of steel sheet

NOM

Code	# of poles	Phase	Characteristics	Maximum current	Inner	Master
FU1017	1	1	110-220 V~	70 A	10	10
FU1019	2	1	110-220 V~	70 A	10	10
FU1021	4	1	110-220 V~	70 A	6	6
FU1402	6	1	110-220 V~	70 A	1	6

Type of packaging: Bulk

ELECTRICAL APPLIANCES | FUSES | SWITCHES



FU1030 / FU1032



FU0752 / FU0858



FU0755 / FU0857

FUSE - Brass sheet washer - Flame resistant polycarbonate body - H Class

Code	Product	Characteristics	Voltage	Inner	Master
FU1030	Reinforced fuse with handle	30 A	250 V~	10	400
FU1032	Reinforced fuse with handle	60 A	250 V~	10	300
FU0752	Reinforced fuse	30 A	250 V~	10	400
FU0858	Reinforced fuse	60 A	250 V~	10	300
FU0755	Fuse	30 A	250 V~	10	800
FU0857	Fuse	60 A	250 V~	10	300



Type of packaging: Box 10 pieces / FU1030 y FU1032 Bulk



FU1031



FU1033



FU1034

FUSE - Brass sheet washer - Flame resistant polycarbonate body - H Class

Code	Product	Characteristics	Voltage	Inner	Master
FU1031	Reinforced fuse with handle, 30 A, set 2 Pieces	30 A	250 V~	10	100
FU1033	Replacement fuse	30 A	250 V~	50	20000
FU1034	Replacement fuse	60 A	250 V~	50	2000

*Price per blister



SPARE PARTS

Type of packaging: Box / FU1031 Blister



- Made of plastic
- On range: 30 PSI adjustable
- Off range: 50 PSI adjustable

HP capacity for 2 poles				
V~	1ø	3ø	FF	
115	1.5	2	0.25	
230	2	3	0.25	
32	-	-	0.25	
A600				

* 60° / 75° CCU only.



PRESSURE SWITCH

Code	Characteristics	Inner	Master
FU0294	Plastic	5	50

Type of packaging: Box



FU0883 / FU0884 / FU0885



FU0880 / FU0881 / FU0882

- Flame resistant
- Protects against power overloads and short circuits
- Interruption range: 10,000 A
- In accordance with NMX - J - 515 ANCE 2008
- For 110 / 220 V~



THERMOMAGNETIC CIRCUIT BREAKER - Manufactured in bakelite

Code	Product	Characteristics	Inner	Master
FU0883	Thermomagnetic circuit breaker, 2 poles	2 X 15 A	5	50
FU0884	Thermomagnetic circuit breaker, 2 poles	2 X 20 A	5	50
FU0885	Thermomagnetic circuit breaker, 2 poles	2 X 30 A	5	50
FU0880	Thermomagnetic circuit breaker, 1 pole	1 X 15 A	10	100
FU0881	Thermomagnetic circuit breaker, 1 pole	1 X 20 A	10	100
FU0882	Thermomagnetic circuit breaker, 1 pole	1 X 30 A	10	100

Type of packaging: Bulk



MULTICONTACT BARS



FU1362



FU1361

- Metallic body
- SJT 3C x 14 AWG cable
- Cable length: 90cm
- Illuminated switch
- Plug and grounded contacts
- Protects against current spikes

MULTICONTACT INDUSTRIAL BAR

- Metallic body - Frecuencia 60 Hz

Code	Product	Outlet	Voltage	Current	Inner	Master
FU1362	Industrial multi-contact bar	10 contacts	120 V~	15 A	2	12
FU1361	Industrial multi-contact bar	6 contacts	120 V~	15 A	4	30

Type of packaging: Case

NOM

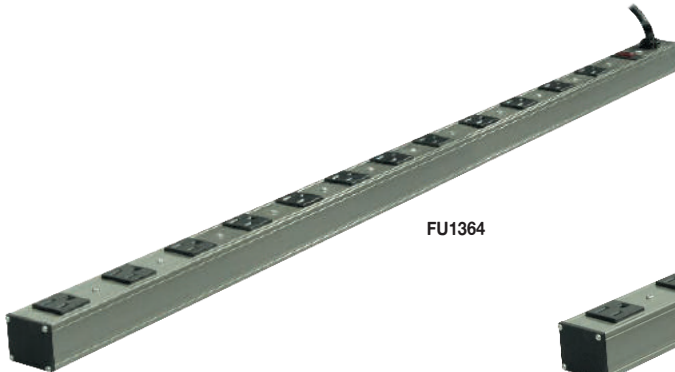

FU1364

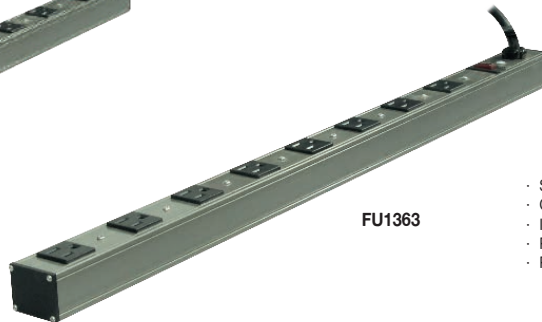

FU1363

- SJT 3C x 14 AWG cable
- Cable length: 180cm
- Illuminated switch
- Plug and grounded contacts
- Protects against current spikes

MULTICONTACT ALUMINUM BAR

- Aluminum body - Frecuencia 60 Hz

Code	Product	Outlet	Voltage	Current	Inner	Master
FU1364	Aluminum multi-contact bar	12 contacts	120 V~	15 A	2	8
FU1363	Aluminum multi-contact bar	8 contacts	120 V~	15 A	2	10

Type of packaging: Case

NOM



ELECTRICAL APPLIANCES | MULTI-CONTACT BARS



FU1035



FU1025

- SJT 3x 16 AWG cable
- Cable length 50 cm
- Plug and grounded contacts
- Domestic and indoor use
- Protects against voltage and current peaks

SPECIFICATIONS	
USB Voltage Output	5 V
USB power output	2.1 A

NOM

MULTI CONTACT BARS WITH USB

- Made of self-extinguishing ABS- Frecuencia 60 Hz

Code	Product	Outlet	Voltage	Current	Inner	Master
FU1035	450 Joules multi-contact bar 2 USB with suppressor	6 contacts	120 V~	13 A	2	20
FU1025	245 Joules multi-contact bar 2 USB with suppressor	3 contacts	120 V~	13 A	4	24

Type of packaging: Case



FU0577



FU0329



FU0578



FU1667

- SJT 3 x 14 AWG Cable
- Cable length: 75cm
- Plug and grounded contacts
- Protects against voltage and current peaks

- 50 cm cable
- Protects only against current spikes

NOM

MULTICONTACT BAR

Made of self-extinguishing ABS - Frecuencia 60 Hz

Code	Product	Outlet	Voltage	Current	Inner	Master
FU0577	450 Joules multi-contact bar with suppressor	5+1 contacts	120 V~	15 A	4	60
FU0329	270 Joules multi-contact bar with suppressor	4+2 contacts	120 V~	15 A	4	60
FU0578	270 Joules multi-contact bar with suppressor	8 contacts	120 V~	15 A	4	60
FU1667	Multi-contact bar without suppressor	8 contacts	120 V~	15 A	4	36

Type of packaging: Case / FU0578 Box



FU0175 · SJT 3 x 14 AWG Cable



FU0981 · Heavy duty cable: 16 AWG

- Cable length: 50cm
- Illuminated switch
- Plug and grounded contacts
- Protects against voltage and current peaks

NOM

MULTICONTACT BAR

Made of self-extinguishing ABS - Frecuencia 60 Hz

Code	Product	Outlet	Voltage	Current	Inner	Master
FU0175	110 Joules multi-contact bar with suppressor	6 contacts	120 V~	15 A	4	60
FU0981	270 Joules multi-contact bar with suppressor	6 contacts	120 V~	15 A	4	60

Type of packaging: Box



FU0173 · Cable length: 50cm



FU1405 · Cable length: 30cm

- SJT 3 x 16 AWG (heavy duty) cable
- Cable length: 50cm
- Illuminated switch
- Plug and grounded contacts
- Protects against current spikes
- The FU1405 bar is black

NOM

MULTICONTACT BAR

Made of self-extinguishing ABS - Frecuencia 60 Hz

Code	Product	Outlet	Voltage	Current	Inner	Master
*FU0173	Multi contact bar	6 contacts	120 V~	15 A	4	60
FU1405	Multi contact bar	6 contacts	120 V~	15 A	4	60

Type of packaging: Box





FU0328 · SJT 3 x 16 AWG (heavy duty) cable
· Cable length: 50cm



FP0047 · Cable 16 AWG
· Cable length: 30cm

- Illuminated switch
- Plug and grounded contacts
- Protects against current spikes

NOM



MULTICONTACT BAR

Made of self-extinguishing ABS - Frecuencia 60 Hz

Code	Product	Outlet	Voltage	Current	Inner	Master
FU0328	Multi contact bar	4 contacts	120 V~	15 A	4	60
FP0047	Multi contact bar	5 contacts	120 V~	15 A	4	60

Type of packaging: Box



- Metallic body
- Heavy duty 14 AWG cable
- Cable length: 75cm
- Illuminated switch
- Plug and grounded contacts
- Protects against voltage and current peaks
- Frequency 60 Hz

NOM



600 JOULES MULTI CONTACT METALLIC BAR

Code	Outlet	Voltage	Current	Inner	Master
FU0979	6 contacts	120 V~	15 A	2	24

Type of packaging: Box



- Multi-contact bar 270 J (FU0173), made of ABS, cable 50 cm 16 AWG, 120 V ~ 60 Hz
- Multi-contact 3 inputs (FU0178)
- Multi-contact 6 inputs (FU0177)
- 3 Grounded plug converter (FU0106) Converts from ground plug into a polarized plug
- Extension cord 16 AWG x 2 (FU0182)
- Frequency 60 Hz

NOM

MULTI-CONTACT SET AND ACCESSORIES, 7 PIECES

Code	Voltage	Current	Inner	Master
FU0536	120 V~	15 A	6	12

Type of packaging: Blister



- Multi-contact bar with 5 outlets, cable 20 cm 16 AWG, 127 V ~ 60 Hz, 270 J
- 1.8 m electrical extension, SPT-2 cable, 16 AWG
- Multi-contacts with 3 grounded contacts
- Frequency 60 Hz

NOM

SET OF MULTI-CONTACT AND EXTENSION, 3 PIECES

Code	Voltage	Current	Inner	Master
FP0057	120 V~	15 A	6	12

Type of packaging: Blister



- Made of self-extinguishing ABS
- Cable length: 30cm
- Illuminated switch
- Plug and grounded contacts
- Protects against current spikes
- Frequency 60 Hz

NOM



MULTI CONTACT BAR, 2-PIECE SET

Code	Outlet	Voltage	Current	Inner	Master
FP0056	5 contacts	120 V~	15 A	4	12

Type of packaging: Case

*Price per blister

ELECTRICAL APPLIANCES | MULTICONTACTS | EXTENSIONS



SPECIFICATIONS	
Voltage Output USB	5 V
Output Current:	
Using 1 USB port	2.1 A
Using 2 USB port	1 A

FU1024



SPECIFICATIONS	
USB Voltage Output	5 V
USB Output Current	2.1 A

FU1023



SPECIFICATIONS	
Voltage Output USB	5 V
USB Output Current	2.1 A

FU1022



MULTI-CONTACTS - Made of self-extinguishing ABS - Domestic use - Protects against voltage and current peaks - Frecuencia 60 Hz

Code	Outlet	Voltage	Power	Suppressor	Inner	Master
FU1024	2 contacts + 2 USB	120 V~	1,875 W	300 J	4	120
FU1023	1 contact + 1 USB	120 V~	1,875 W	150 J	4	120

MULTI CONTACT, 2-PIECE SET

FU1022	1 contact + 1 USB	120 V~	1,875 W	150 J	2	120
--------	-------------------	--------	---------	-------	---	-----

Type of packaging: Blister



FU0177 · Connects to a duplex contact



FU0589 · Indicator light



FU0180 · Hinge that allows adjusting to different angles

GROUNDING MULTI-CONTACTS - Made of self-extinguishing ABS - Frecuencia 60 Hz

Code	Product	Outlet	Voltage	Power	Current	Inner	Master
FU0177	Square multi contact	6 contacts	120 V~	1,875 W	15 A	10	60
FU0589	Multi contact with indicator light	3 contacts	120 V~	1,875 W	15 A	20	120
FU0180	Multi-contact with hinge	3 contacts	120 V~	1,875 W	15 A	20	120

Type of packaging: Blister



FU0595 · Reinforced for heavy-duty



FU0573 · Reinforced for heavy-duty



FU0178

GROUNDING MULTI-CONTACTS - Made of rubber - Frecuencia 60 Hz

Code	Product	Outlet	Voltage	Power	Current	Inner	Master
FU0595	Grounded triple multi-contact	3 contacts	120 V~	1,875 W	15 A	20	120
FU0573	T-shaped triple connector	3 contacts	120 V~	1,875 W	15 A	20	120
FU0178	Grounded triple multi contact bar	3 contacts	120 V~	1,875 W	15 A	20	120

Type of packaging: Blister



FU0179



FP0055



FP0054

MULTI-CONTACT TRIPLE POLARIZED SQUARE

Code	Color	Voltage	Power	Current	Inner	Master
FU0179	White	120 V~	1,875 W	15 A	20	120
FP0055	White	120 V~	1,875 W	15 A	50	400
FP0054	Brown	120 V~	1,875 W	15 A	50	400

Type of packaging: FU Blister / FP Granel





- Made of polyvinyl
- Cable type: SJT - 16 AWG x 2 C
- 3 polarized outlets
- With design to connect grounded pins
- 120 V ~ 1,651 W
- Maximum temperature: 60 ° C

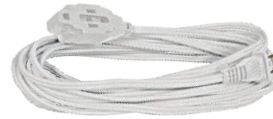

- Made of polyvinyl
- Cable type: SPT-2 16 AWG x 2 C
- 3 contacts
- With design to connect grounded pins
- 120 V ~ 1,651 W
- Flat head plug
- Temperature 60° C
- For indoor use

HEAVY DUTY ORANGE EXTENSION CORD 2 X 16 GAUGE

Code	Length	Current	Inner	Master
*FP0159	4 m	13 A	10	60
FP0160	6 m	13 A	10	40
FP0161	8 m	13 A	5	30
FP0162	10 m	13 A	5	20
FP0163	15 m	13 A	5	15
FP0156	20 m	13 A	4	12
FP0157	30 m	13 A	4	8

Type of packaging: Case



WHITE EXTENSION CORD, 2 X 16

Code	Length	Current	Inner	Master
*FP0060	2 m	13 A	10	100
*FP0061	3 m	13 A	10	100
*FP0062	4 m	13 A	10	80
FP0063	5 m	13 A	10	80
FP0064	6 m	13 A	10	50
FP0065	8 m	13 A	10	50
*FP0066	10 m	13 A	10	40

Type of packaging: Case



- Cable type: SJT - 14 AWG x 3 C
- 100% copper conductor

FU1216 - FU1219



- Cable type: SJT - 16 AWG x 3 C
- 100% copper conductor

FU0269 - FU0271 y FU1352

Do not exceed the recommended load (A)

REINFORCED YELLOW EXTENSION, 3 X 14 GAUGE

- Double polyvinyl insulation - 1 grounded socket - Maximum temperature 60° C

Code	Length	Characteristics	Current	Inner	Master
FU1216	5 m	120 V ~ 1,651 W	13 A	4	20
FU1217	10 m	120 V ~ 1,651 W	13 A	2	10
FU1218	15 m	120 V ~ 1,651 W	13 A	2	8
FU1219	30 m	120 V ~ 1,651 W	13 A	1	6

NOM

EXTENSION HEAVY-DUTY YELLOW 3 X 16 GAUGE

FU0269	5 m	120 V ~ 1,905 W	15 A	5	25
FU0270	10 m	120 V ~ 1,905 W	15 A	4	16
FU0271	15 m	120 V ~ 1,905 W	15 A	3	12
FU1352	30 m	120 V ~ 1,905 W	10 A	1	6



Type of packaging: Case



- Cable type: SJT - 16 AWG x 3C
- 100% copper conductor
- Three Angle Outlet 3-Prong Power Extension Cord

FU0211 / FU0212



- Cable type: SJT - 16 AWG x 3 C
- 100% copper conductor
- Protects against current spikes

FU1067

NOM

Do not exceed the recommended load (A)

EXTENSION WITH MULTICONTACTO 3 X 16 GAUGE

- Made of polyvinyl - Maximum temperature: 60 ° C

Code	Outlet	Length	Characteristics	Current	Inner	Master
FU0211	3 contacts	8 m	120 V ~ 1,900 W	15 A	2	20
FU0212	3 contacts	15 m	120 V ~ 1,900 W	15 A	1	16



6 METERS EXTENSION

FU1067	6 contacts	6 m	120 V ~ 1625 W	13 A	1	6
--------	------------	-----	----------------	------	---	---

Type of packaging: Cover (Box FU1067)

ELECTRICAL APPLIANCES | WORK LIGHT | CABLES



FU0170

- Cable type: SJT 16 AWG x 3C
- 100% copper conductor
- For energy-efficient and incandescent bulb
- Heavy-duty cable with double coating
- Includes ground contact
- E27 Base



FU0172

- Cable type: SJT-2 16 AWG x 2C
- 100% copper conductor
- For energy-efficient and incandescent bulb
- E27 Base



FU0377

- Cable type: SJT 18 AWG x 2C
- 100% copper conductor
- Bypass switch
- Includes 1 13 W fluorescent tube
- Life: 8,000 hours
- Daylight

WORK LIGHT

- Plastic handle - For exterior and interior use - Frecuencia 60 Hz

Code	Product	Characteristics	Length	Current	Inner	Master
FU0170	Metal basket	120 V ~ 75 W	15 m	15 A	2	12
FU0172	Plastic basket	120 V ~ 70 W	15 m	15 A	3	12
FU0377	Fluorescent	120 V ~ 13 W	1.8 m	0.1 A	2	16

Spare parts (FU0170)

FU0371	Plastic handle	10	40
FU0372	Metal basket	10	100

NOM



Type of packaging: Box

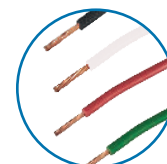

- Maximum operating voltage: 600 V
- Working temperature: 75° C / 90° C
- Copper conductor
- For indoor or outdoor use
- Low voltage cable
- 100 m rolls presentation

THHW CABLE

Code	Color	AWG	Caliber	External diameter	Approx. weight per roll	Inner	Master
FU1060	Black	8	8	5.98 mm	10.5 kg	1	1
FU1061	White	8	8	5.98 mm	10.5 kg	1	1
FU1062	Red	8	8	5.98 mm	10.5 kg	1	1
FU1063	Green	8	8	5.98 mm	10.5 kg	1	1
FU1046	Black	10	10	4.45 mm	6.14 kg	1	1
FU1047	White	10	10	4.45 mm	6.14 kg	1	1
FU1048	Red	10	10	4.45 mm	6.14 kg	1	1
FU1064	Green	10	10	4.45 mm	6.14 kg	1	1
FU1049	Black	12	12	3.85 mm	4.12 kg	1	1
FU1050	White	12	12	3.85 mm	4.12 kg	1	1
FU1051	Red	12	12	3.85 mm	4.12 kg	1	1
FU1065	Green	12	12	3.85 mm	4.12 kg	1	1
FU1052	Black	14	14	3.37 mm	2.90 kg	1	1
FU1053	White	14	14	3.37 mm	2.90 kg	1	1
FU1054	Red	14	14	3.37 mm	2.90 kg	1	1
FU1066	Green	14	14	3.37 mm	2.90 kg	1	1



Flame resistant

NOM



Type of packaging: Box



FU1072 - FU1075 · Work temperature: 60° C



FU1070 · Working temperature: 105° C

HEAVY-DUTY CORD

- Resistance to tension: 600 V ~ 100m Roll - Copper conductor

Code	External diameter	Characteristics	Current	Approx. weight per roll	Threads	Inner	Master
FU1073	7.32 mm	2X18 AWG	10 A	6.84 kg	16	1	1
FU1072	7.60 mm	2X16 AWG	13 A	7.89 kg	26	1	1
FU1075	13.70 mm	3X14 AWG	15 A	14.12 kg	41	1	1
FU1074	15.60 mm	3X12 AWG	20 A	18.96 kg	65	1	1

NOM

TYPE 3 ELECTRODE CABLE

FU1070	11.77 mm	Type 3; 2 AWG	-	45.28 kg	665	1	1
--------	----------	---------------	---	----------	-----	---	---

Type of packaging: Box





- Duplex cord with white jacket
- Voltage resistance: 300 V~
- Work temperature: 60° C
- 100 m roll presentation

FLEXIBLE CORD

Code	External diameter	Characteristics	Approx. Weight per roll	Inner	Master
FU1055	9.10 mm	SPT-3 10 AWG	16.55 kg	1	1
FU1056	7.50 mm	SPT-3 12 AWG	10.27 kg	1	1
FU1057	7.15 mm	SPT-2 14 AWG	4.40 kg	1	1
FU1058	5.50 mm	SPT-2 16 AWG	4.00 kg	1	1
FU1059	2.80 mm	SPT-1 18 AWG	3.18 kg	1	1

NOM



Type of packaging: Roll



FU0767



FU0766



CABLE FOR SPEAKERS

- PVC jacket - Gauge: 22 AWG - 100 m roll

Code	Product	Characteristics	Inner	Master
FU0767	Polarized speaker wire	Polarized	4	12
FU0766	Bi-color speaker cable	Bi-color	4	12



Type of packaging: Roll



- Polypropylene reel
- Rectangular steel cable (3.24 x 1.53 mm)
- Ergonomic handle



- Cable made of nylon
- Brass tips
- 1/8" diameter round cable



STEEL FISH TAPE

Code	Length	Inner	Master
FU0238	50 m (15')	5	20
FU0239	30 m (100')	3	12

Type of packaging: Card

NYLON CABLE GUIDE

Code	Length	Inner	Master
FU1359	15 m	10	80
FU1360	30 m	5	60

Type of packaging: Bag



- Made of 0.55 mm 100% virgin PVC
- With highly resistant inner clips for easy installation.
- For cover and conceal all kinds of wires.
- 2 m long

PLASTIC WIRE CHANNEL

Code	Measurement	Ways	Characteristics	Inner	Master
FU0749	12 x 12 mm	1 way	without glue	20	50
FU0750	20 x 10 mm	1 way	without glue	20	50
FU0751	20 x 15 mm	1 way	without glue	20	40
FU0886	35 x 17 mm	2 ways	without glue	20	20
FU0887	12 x 12 mm	1 way	with glue	10	50
FU0888	20 x 10 mm	1 way	with glue	10	50
FU0889	20 x 15 mm	1 way	with glue	10	40

Type of packaging: Bulk



FU1599



FU1600



FU1601 - FU1603

TWIST-ON WIRE CONNECTORS - Made of nylon

Code	AWG Caliber	Characteristics	Color	Pieces per bag	Inner	Master
FU1599	#18 - #12	With internal thread	Yellow	10	20	120
FU1600	#14 - #10	With internal thread	Red	5	20	160
FU1601	#22 - #16	Without cap	Transparent	100	10	160
FU1602	#16 - #14	Without cap	Transparent	100	10	160
FU1603	#12 - #10	Without cap	Transparent	100	10	80

Tipo de empaque: Bolsa



*Price per bag



SIMPLE WIRE CONNECTORS - Made of nylon - Thread with metal insert

Code	AWG Caliber	Color	Pieces per bag	Inner	Master
FU0479	#22 - #18	Grey	50	20	160
FU0480	#18 - #16	Blue	25	20	160
FU0481	#16 - #14	Orange	20	20	160
FU0482	#14 - #12	Yellow	10	20	80
FU0483	#12 - #10	Red	5	20	80

Tipo de empaque: Bolsa



*Price per bag



- Made of PVC
- Acrylic base adhesive
- Width: 19 mm
- Thickness: 0.18 mm + - 10%
- Resists up to 80 °C
- Insulation capacity: 600 V ~
- Elongation: 180%



ELECTRICAL TAPE

Code	Color	Length	Inner	Master
*FU0700	Black	18 m	10	150
FU0379	White	18 m	10	150
FU0380	Red	18 m	10	150
FU0381	Blue	18 m	10	150
FU0382	Yellow	18 m	10	150
FU0383	Green	18 m	10	150
FU0069	Black	8 m	24	250
FU0378	Black	18 m	12	144

Type of packaging: Shrinkable / FU0378 Blister



- Made of PVC
- Thickness: 0.13 mm
- Width: 18 mm
- Resists up to 80 °C
- Insulation capacity: 600 V ~
- Acrylic base adhesive
- Elongation: 160%



ELECTRICAL TAPE

Code	Color	Length	Inner	Master
FP0019	Black	8 m	10	200
*FP0018	Black	15 m	10	200
FP0021	Black	15 m	24	144

Type of packaging: Shrinkable / FP0021 Blister



- Made of PVC
- Thickness: 0.13 mm
- Width: 18 mm
- Resists up to 80 °C
- Insulation capacity: 600 V ~
- Acrylic base adhesive
- Elongation: 160%

COLORED ELECTRICAL TAPE, 6 PACK

*Price per shrinkable

Code	Colors	Length	Inner	Master
FP0020	Red, white, yellow, green, black and blue	6 m	10	100

Type of packaging: Shrinkable





- Made of high resistance nylon
- Temperature range: -20 °C to 85 °C
- For exterior, commercial, industrial and construction use
- White color

Useful to secure heavy ducts, cables, scaffolding, wooden planks and metal poles provisionally.

HIGH RESISTANCE PLASTIC CABLE TIE

*PRICE PER BAG

Code	Length	Pressure lb / kg	Pieces per bag	Length / width millimeters	Inner	Master
FU1390	20cm / 8"	120 lb / 54 kg	10	7.6 / 200mm	12	72
FU1391	30cm / 12"	120 lb / 54 kg	10	7.6 / 300mm	12	72
FU1392	35cm / 14"	120 lb / 54 kg	10	7.6 / 350mm	12	72
FU1393	46cm / 18"	120 lb / 54 kg	10	7.6 / 450mm	12	72
FU1394	56cm / 22"	120 lb / 54 kg	10	7.6 / 550mm	12	72
FU1395	76cm / 30"	120 lb / 54 kg	10	7.6 / 750mm	12	72
FU1396	46cm / 18"	175 lb / 80 kg	10	9.0 / 450mm	12	48
FU1397	61cm / 24"	175 lb / 80 kg	10	9.0 / 610mm	12	48
FU1398	71cm / 28"	175 lb / 80 kg	10	9.0 / 710mm	12	48
FU1399	91cm / 36"	175 lb / 80 kg	10	9.0 / 920mm	12	48
FU1400	122cm / 48"	175 lb / 80 kg	10	9.0 / 1220mm	12	48

Type of packaging: Bag



- Made of ABS
- Temperature range: -20 °C a 80°C

LIGHT USE

PLASTIC CABLE TIE

*PRICE PER BAG

Code	Length	Pressure lb / kg	Pieces per bag	Length / width millimeters	Inner	Master
WHITE						
FU0260	10 cm / 4"	18 lb / 8 kg	100	102 / 2.5 mm	12	384
FU0261	15 cm / 6"	40 lb / 18 kg	50	152 / 3.5 mm	12	144
FU0262	20 cm / 8"	50 lb / 23 kg	50	203 / 4.5 mm	12	192
FU1205	25 cm / 10"	50 lb / 23 kg	50	254 / 4.5 mm	12	192
FU0263	30 cm / 12"	50 lb / 23 kg	50	305 / 4.5 mm	12	192
FU0264	35 cm / 14"	50 lb / 23 kg	50	356 / 4.5 mm	12	108
FU0788	46 cm / 18"	50 lb / 23 kg	25	457 / 4.5 mm	15	120
FU0789	51 cm / 20"	50 lb / 23 kg	25	508 / 4.5 mm	15	120
FU1207	41 cm / 16"	50 lb / 23 kg	50	406 / 4.5 mm	12	108
BLACK						
FU0278	10 cm / 4"	18 lb / 8 kg	100	102 / 2.5 mm	12	384
FU0279	15 cm / 6"	40 lb / 18 kg	50	152 / 3.5 mm	12	144
FU0280	20 cm / 8"	50 lb / 23 kg	50	203 / 4.5 mm	12	192
FU1206	25 cm / 10"	50 lb / 23 kg	50	254 / 4.5 mm	12	192
FU0281	30 cm / 12"	50 lb / 23 kg	50	305 / 4.5 mm	12	192
FU0282	35 cm / 14"	50 lb / 23 kg	50	356 / 4.5 mm	12	108
FU0791	46 cm / 18"	50 lb / 23 kg	25	457 / 4.5 mm	15	120
FU0792	51 cm / 20"	50 lb / 23 kg	25	508 / 4.5 mm	15	120
FU1208	41 cm / 16"	50 lb / 23 kg	50	406 / 4.5 mm	12	108

Type of packaging: Bag



- Made of ABS



ASSORTED PLASTIC STRAPS 650 PIECES

Code	Characteristics	Temperature range:	Inner	Master
FP0009	650 pieces	- 20 °C a 80 °C	1	12

Type of packaging: Plastic can

Cable tie measure-	Pieces	Color
4.8 mm x 12"	(50 pzs)	White
4.8 mm x 8"	(300 pzs)	White
2.5 mm x 4"	(100 pzs)	White
2.5 mm x 4"	(50 pzs)	Red
2.5 mm x 4"	(50 pzs)	Black
2.5 mm x 4"	(50 pzs)	Blue
2.5 mm x 4"	(50 pzs)	Yellow

- 4.8mm cable tie support a tension of 50 lb / 23 kg
- 2.5mm cable tie support a tension of 18 lb / 8 kg

MULTIMETER



Characteristics	
DC voltage	200mV-1000V
AC voltage	200mV-750V
DC current	200mA-20A
AC current	2mA-20A
Resistance	200Ω-200MΩ
Temperature °C	0 °C-1000°C
Temperature F°	32 °F-1832 °F
Capacity	200pF - 200uF
Frequency	2kHz - 200kHz

- Diode and continuity test
- NPN or PNP (0-1000B) transistor test
- Impact resistant protective cover
- Includes 1 battery (9V)
- 3 1/2" LCD screen with lighting



MULTÍMETRO DIGITAL PROFESIONAL

Code	Current	Inner	Master
FU1248	15 A	1	20

Type of packaging: Box



Characteristics	
DC voltage	2V-1000V
AC voltage	2V-750V
DC current	20mA-10A
AC current	20mA-10A
Resistance	200Ω-20MΩ
Temperature °C	-20 °C-1000°C
Temperature F°	0 °F-1832 °F
Cylinder capacity	3CYL/ 4CYL/ 5CYL/ 6CYL/ 8CYL

- Diode and continuity test
- NPN or PNP (0-1000B) transistor test
- Impact resistant protective cover
- Includes 2 (1.5V) batteries
- 3 1/2" LCD screen with lighting



AUTO-RANGING PROFESSIONAL DIGITAL MULTIMETER

Code	Current	Inner	Master
FU1247	15 A	1	20

Type of packaging: Box



Characteristics	
DC voltage	400mV-750V
AC voltage	400mV-750V
AC current	2A-600A
Resistance	400Ω-40MΩ
Temperature °C	-20 °C-1000°C
Temperature F°	0 °F-1832 °F

- Diode and continuity test
- NPN or PNP (0-1000B) transistor test
- Impact resistant protective cover
- Includes 3 (1.5V) batteries
- 3 1/2" LCD screen with LED lighting
- Built-in flashlight design



PROFESSIONAL DIGITAL CLAMP METER

Code	Characteristics	Inner	Master
FU1246	Clamp	1	30

Type of packaging: Box



Characteristics	
DC voltage	200 mV - 1000 V-
AC voltage	200 V- - 750 V-
AC current	20 A - 1000 A
Resistance (Ω)	2 KΩ - 2 mΩ
Temperature °C	0 - 750 °C
Temperature F°	32 °F-1382 °F

- 3 1/2 digit LCD screen
- Screen freezing button
- Measures DC and AC temperature resistance
- Polarity indicator
- Works with 9 V- batteries



DIGITAL CLAMP METER

Code	Characteristics	Inner	Master
FP0076	9 V-	2	20

Type of packaging: Box



- 3 1/2 digit LCD screen
- Low battery indicator
- Polarity indicator
- Measures VDC, VAC, resistance, diodes, transistor, continuity

*Battery powered

Characteristics	
DC voltage	2 V - 500 V
AC voltage	2 V - 500 V
DC current	200 mA
Resistance	(Ω): 200 KΩ - 2000 KΩ



POCKET-SIZE DIGITAL MULTIMETER

Code	Characteristics	Inner	Master
FP0078	12 V~	4	60

Type of packaging: Blister



- 3 1/2 digital screen
- Transistor tester
- Measures VDC, VAC, resistance, diodes, transistor, continuity
- Polarity indicator

*9V- battery powered

Characteristics	
DC voltage	200 mV - 1000 V
AC voltage	200 V - 750 V~
DC current	200 μA - 10A
Resistance	200 Ω - 2000 KΩ



DIGITAL MULTIMETER

Code	Characteristics	Inner	Master
*FP0077	9 V~	5	60

Type of packaging: Blister



- LED indicator with AC/DC individual reading
- Voltage check
- 150 V - 300 V - 500 V (DC)
- 120 V - 240 V - 380 V (AC)

SPECIFICATIONS	
DC voltage	150 - 500 V $\overline{\text{---}}$
AC voltage	110 - 380 V~

NOM



120 V - 500 V VOLTAGE TESTER

Code	Characteristics	Inner	Master
FU0225	AC/DC	6	120

Type of packaging: Blister



- Digital voltage tester with AC/DC DC individual reading
- Screwdriver-type tip
- For checking voltage at home, office or work shop

SPECIFICATIONS	
Voltage	12 - 250 V~
Voltage type	AC/DC

NOM



DIGITAL VOLTAGE TESTER

Code	Characteristics	Inner	Master
FU0224	Digital	15	300

Type of packaging: Blister



FU0226

- Polarity tester (+) (-) DC voltage
- For measuring 6 - 12 - 24 V-

SPECIFICATIONS	
DC voltage	6 - 24 V $\overline{\text{---}}$
AC voltage	6 - 24 V~
Voltage type	DC



FU0220

- Insulated circuit tester with steel tip terminals

SPECIFICATIONS	
DC voltage	110 - 460 V $\overline{\text{---}}$
AC voltage	110 - 460 V~
Frequency	60 Hz

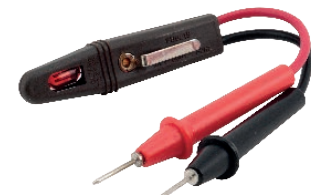

FU0219

- Insulated circuit tester with steel tip terminals
- 4 halogen visual indicators
- For industrial use

SPECIFICATIONS	
DC voltage	80 - 500 V $\overline{\text{---}}$
AC voltage	80 - 500 V~
Frequency	60 Hz

NOM



CURRENT TESTER

Code	Product	Characteristics	Inner	Master
FU0226	Direct	AC/DC	6	120
FU0220	Professional	AC / DC	12	200
FU0219	Single	AC / DC	12	240

Type of packaging: Blister

VOLTAGE AND CIRCUIT TESTER



FU0221

- Circuit with orange halogen lamp and protection element.
- Frequency 60 Hz

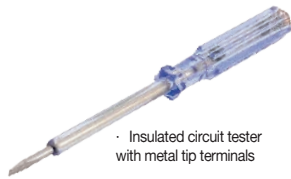

FU0222 - FU0223

- Insulated circuit tester with metal tip terminals

Specifications	FU0221	FU0222	FU0223
Voltage	6 - 12 - 24 V~	100 - 500 V~	100 - 500 V~
Voltage type	DC	AC	AC



AUTOMOTIVE CIRCUIT TESTER, 3 PIECES

Code	Characteristics	Inner	Master
FU0228	3 pieces / automotive	12	144

Type of packaging: Blister

SPECIFICATIONS	
AC voltage	100 - 500 V~
DC voltage	6 - 12 - 24 V~



CURRENT TESTER

- Insulated tester with metal terminals

Code	Characteristics	Inner	Master
FU0221	Auto-ranging	12	250
FU0222	Screwdriver type 140 mm	30	240
FU0223	Screwdriver type 190 mm	30	240

Type of packaging: Blister



FU0231



FU0232



More solderin iron in the section [V7 TOOLCRAFT](#)
Página 36



SOLDERING GUNS

Chrome steel tip Galvanized steel tube Fingertip trigger On indicator light Cable length: 95cm - Frecuencia 60 Hz

Code	Type of use	Voltage	Power	Maximum temperature	Inner	Master
FU0231	Heavy-duty	120 V~	100 W	500 °C	2	24
FU0232	Medium	120 V~	35 W	420 °C	6	36

Type of packaging: FU0231 Box / FU0232 Blister



- Type of packaging: Box
- Receives local, analog and digital HD channels
- Broadband amplifier for better image and sound reception
- 3 m coaxial cable

SPECIFICATIONS	
Signal	VHF / UHF
Impedance	75 Ohms
Frequency	VHF: 168-230 MHz UHF: 470-860 MHz
High-gain	VHF: 10-12 dB UHF: 22 dB
Feed	AC 120 V~



90° HD ANTENNA WITH AMPLIFIER

Code	Characteristics	Inner	Master
FU1151	90° HD antenna	2	20

Type of packaging: Box



FU1044



FU1045

- Broadband amplifier for better image and sound reception
- Includes antenna support
- 45 cm cable adapter

SPECIFICATIONS		
	FU1044	FU1045
Signal	VHF / UHF	VHF / UHF
Impedance	75 Ohms	75 Ohms
Frequency	VHF: 160-230MHz UHF: 470-862 MHz	VHF: 47-230MHz UHF: 470-862 MHz
High-gain	VHF: 1-2 dBi / 16-17 dBi UHF: 4-5 dBi / 19-20 dBi	VHF: 1-2 dBi / 17-18 dBi UHF: 4-5 dBi / 19-20 dBi
Cable coaxial	1.5 C - 2 V~ x 1.45 m	RG-59 x 1.45 m
Feed	-	AC120V~
Voltage	-	DC6V 100mA



INDOOR FLAT HD ANTENNA

- Receives local HD, analog and digital channels. - Slim design

Code	Characteristics	Inner	Master
FU1044	9" Antenna	6	20
FU1045	13" antenna with amplifier	2	20

Type of packaging: Box

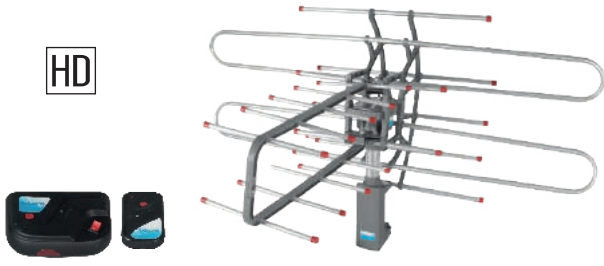

HD

- Big size for better reception
- Damp resistant structure
- 360° rotation
- Analog and VHF / UHF channel reception in (HD)
- Receiver with button to rotate the antenna
- Remote control with a reach of up to 8 m
- Control uses 2 "AAA" batteries, not included



Includes:
Coaxial cable antenna - receiver (12 m)
Coaxial cable receiver - television (1 m)

SPECIFICATIONS	
Signal	VHF / UHF
Impedance	75 Ohms
Frequency	VHF: 160-230MHz UHF: 470-862 MHz
High-gain	VHF: 1-2 dBi / 16-17 dBi UHF: 4-5 dBi / 19-20 dBi
Cable coaxial Coaxial cable	1.5 C - 2 V-
Receptor	120 V- 60 Hz 3W



ROTATING ANTENNA WITH REMOTE CONTROL

Code	Characteristics	Inner	Master
FU0622	Roatating HD	3	6

Type of packaging: Box



HD

- Damp resistant structure
- 360° rotation with remote control
- Reception of VHF / UHF and HD channels
- Receiver with button to rotate the antenna
- Remote control with a reach of up to 8 m
- Remote control uses 2 "AAA" batteries, not included



Includes:
Coaxial cable antenna - receiver (10 m)
Coaxial cable receiver - television (1 m)

SPECIFICATIONS	
Signal	VHF / UHF
Impedance	75 Ohms
Frequency	VHF: 160-230MHz UHF: 470-862 MHz
High-gain	VHF: 1-2 dBi / 16-17 dBi UHF: 4-5 dBi / 19-20 dBi
Cable coaxial Coaxial cable	1.5 C - 2 V-
Receptor	120 V- 60Hz 3W



ROTATING HD ANTENNA WITH REMOTE CONTROL

Code	Characteristics	Inner	Master
FU0903	Roatating HD	2	6Type oB

Type of packaging: Box



FU0859

- Place the aerial antenna on your roof and enjoy a better signal
- For analog (VHF) channels and digital signals (UHF)

SPECIFICATIONS	
Signal	VHF / UHF
Impedance	75 Ohms
Frequency	47 MHz - 960 MHz
High-gain	VHF: (channels 2 to 13) UHF: (channels 14 to 83)



AERIAL ANTENNA

Code	Characteristics	Inner	Master
FU0859	4 modules	4	16

Type of packaging: Box



FU0843

- Concave dish antenna, optimizes UHF / VHF / FM reception
- It has a pair of metal antennas with 4 positions and control of twelve options for signal reception
- For analog channels (VHF) and digital signals (UHF)
- Includes:
90 cm Coaxial cable (75 Ohms impedance)
and 85 cm flat cable (300 Ohms impedance)



Cable coaxial
Coaxial cable



Flat cable



FU0621

- Includes: coaxial cable of 85 cm (75 Ohms impedance)
- For analog VHF channels

ANTENNA

Code	Product	Characteristics	Inner	Master
FU0843	Indoor antenna (Radar)	Universal antenna, coaxial / flat cable	1	20
FU0621	Indoor antenna with coaxial cable	Coaxial cable	20	200

Type of packaging: Box FU0843 / Bag FU0621



VIDEO AND TELEPHONY | ANTENNAS | CABLES



FU0574

- Includes: coaxial cable of 95 cm (75 Ohms of impedance)
- For analog channels (VHF)



FU0575

- Includes: 95 cm Coaxial cable (75 Ohms impedance)
- Flat Cable of 92 cm (300 Ohms impedance)
- For analog channels (VHF) and digital signals (UHF)



Cable coaxial
Coaxial cable



Flat cable

ANTENNA

- 180° opening

Code	Product	Characteristics	Inner	Master
FU0574	Indoor antenna with base	With base and coaxial cable	20	70
FU0575	Indoor antenna with base and double loop	With base, double loop and coaxial / flat cable	20	70

Type of packaging: Bag



FU0624



FU0914



FU0623



FU0915



COAXIAL CABLE

- Impedance 75 Ohms - Cable caliber: 20 AWG

Code	Class	Characteristics	Length	Number of threads	Inner	Master
FU0624	RG-6/U	For television and high definition	100 m	64	1	5
FU0914	RG-6/U	For television and high definition	500 m	64	1	1
FU0623	RG-59/U	For broad band transmissions and antennas	100 m	48	1	5
FU0915	RG-59/U	For broad band transmissions and antennas	500 m	48	1	1

Type of packaging: Roll / Reel



FU0631



FU0630



FU0632

- Sealed box separation
- Corrosion-resistant finish
- For indoor and outdoor use
- For VHF, UHF, and FM signals
- Screws included

SPLITTER

Code	Characteristics	Inner	Master
FU0630	2 outlets	25	1000
FU0631	3 outlets	25	500
FU0632	4 outlets	25	500

Type of packaging: Bag



FU0634

- Resistance and flexibility
- For different signal input interconnection
- VHF, FM signal
- 5 - 900 MHz
- 75 - 300 ohms



FU0636

- Resistance and flexibility
- For different signal input interconnection
- VHF, FM signal
- 5 - 900 MHz
- 75 - 300 ohms



FU0635

- Converts two terminals into a female input for coaxial cable
- UHF, VHF and FM band
- 5-900 MHz

ACCESSORIES

Code	Product	Inner	Master
FU0634	Impedance transformer, outdoor use	100	1000
FU0636	Impedance transformer, Indoor use	100	1000
FU0635	Antenna adapter	100	1000

Type of packaging: Bulk



- For coaxial cable
- F type

FU0629



- For TV antenna, satellite TV and other video systems connections
- F type
- Loose barrel

FU0625 / FU0626



- For TV antenna, satellite TV and other video systems connections
- F type
- Loose barrel

FU0627 / FU0628

CONNECTOR

Code	Product	For cable	Inner	Master
FU0629	F - Connector coupler	RG6	100	5000
FU0625	Crimp-on F-Connector (Bell like)	RG59	100	10000
FU0626	Crimp-on F-Connector (Bell like)	RG6	100	10000
FU0627	Twist-on F-Connector	RG59	100	5000
FU0628	Twist-on F-Connector	RG6	100	5000

Type of packaging: Bulk



FU1005

- Distance from wall: 100mm - 600 mm



FU1003



FU1004

TV WALL MOUNTS

- Made of steel
- Weight capacity 50 kg
- Includes pegs, pulleys and installation accessories

Code	Product	Movement	TV capacity	VESA compatible	Inner	Master
FU1005	Double arm TV wall mount	Swiveling movement +19° - 19°	22" to 47"	100, 200, 300, 400	1	2
FU1003	Fixed or angular movement	Angular: 0° - 10°	22" to 65"	100, 200, 300, 400, 600	1	2
FU1004	Fixed, No movement	No movement	22" to 65"	400 and 600	1	4



Type of packaging: Box



- Higher resistance and flexibility
- 4-line plug with color code
- For telephone lines
- Includes plugs



Telephone connection



- 4-line plug with color code
- For telephone lines
- Includes plugs



For earphone



TELEPHONE LINE CORD

Code	Length	Inner	Master
FU0645	2.1 m	20	400
FU0646	4.5 m	20	200
FU0647	7.5 m	20	200

Type of packaging: Bag

SPIRAL CABLE FOR HANDSET

Code	Color	Length	Inner	Master
FU0648	Ivory	2.1 m	20	200
FU0649	Ivory	4.5 m	20	200
FU0650	White	2.1 m	20	200
FU0651	White	4.5 m	20	200

Type of packaging: Bag



- Converts two RCA terminals into a stereo male terminal



- Plastic body
- 5-900 MHz

MALE STEREO CABLE TO 2 RCA MALES

Code	Length	Inner	Master
FU0642	1.8 m	20	500

Type of packaging: Bag

MALE CONNECTOR TO 2 FEMALE ADAPTER

Code	Characteristics	Inner	Master
FU0637	5-900 MHz	100	1000

Type of packaging: Bulk



- 3 male plug connectors to 3 male plugs
- Color code
- Resistance and flexibility

**AUDIO / VIDEO RCA CABLE
6 MALE CONNECTORS**

Code	Length	Inner	Master
FU0643	1.8 m	20	250
FU0644	2.75 m	20	250

Type of packaging: Bag



- Made of polyethylene
- For cable installation
- Includes steel nail



NAIL-IN CABLE CLIP, CURVED

Code	Color	Measurement	Pieces x bag	Inner	Master
FU0470	White	5 mm	100	20	160
FU0471	White	6 mm	100	20	160
FU0472	White	8 mm	100	20	160
FU0473	White	10 mm	100	10	80
FU0474	White	12 mm	50	10	80
FU0475	White	16 mm	50	10	80
FU0713	Black	6 mm	100	20	160

Type of packaging: Bag



- Made of polyethylene
- For cable installation
- Includes steel nail
- Bag with 100 pieces



NAIL-IN FLAT CABLE CLIP, WHITE

Code	Measurement	Inner	Master
FU0476	5 mm	20	160
FU0477	8 mm	20	160
FU0478	10 mm	10	80

Type of packaging: 100-pieces bag



- Made of plastic
- Heavy-duty
- Temperature range: -40°C a 65°C
- Includes steel nail



*Price per bag

HEAVY-DUTY NAIL-IN CABLE CLIP

Code	Measurement	Pieces per bag	Inner	Master
FU1604	5 mm	100	20	160
FU1605	6 mm	100	20	160
FU1606	7 mm	100	20	160
FU1607	8 mm	100	10	80

Type of packaging: Bag



- Made of plastic
- Temperature range: -40°C a 65°C
- Includes 2 steel nails



*Price per bag

DOUBLE NAIL-IN CABLE CLIP

Code	Measurement	Pieces per bag	Inner	Master
FU1608	32 mm	100	2	12
FU1609	40 mm	50	2	16

Type of packaging: Bag



FU1015

- Program up to 8 events per day
- Program: Monday to Friday, Mon, Wed, Fri / Sat, Sun, etc.
- LCD screen with hours and minutes
- 12/24 hour mode option
- Daylight saving time available

Before using the timer charge it for 12 or 24 hours. If it does not turn on, press rear button with a sharp object.



FU0716

- Up to 48 intervals
- Can be used to plug fans, evaporators, christmas lights, night lights, and lamps with timer.



FU1014

- Can be used to plug fans, evaporators, christmas lights, night lights, and lamps with timer.

*Price per blister

TIMER

- 1 grounded connector - Ideal to simulate presence at home and office - Frecuencia 60 Hz

Code	Product	Characteristics	Voltage	Max power	Current	Inner	Master
FU1015	Digital 24 hours, 7 days	1 min intervals	120 V~	1,270 W	10 A	6	36
FU0716	24 hours analogue	15 min intervals	120 V~	1,100 W	15 A	4	48
FU1014	24 hours analog, 2-pieces set	30 min intervals	120 V~	1,905 W	15 A	6	36

Type of packaging: Blister





- 4 temperatures
- Cold: 0 W consumption
- Warm: 1,600 W
- Hot: 3,200 W consumption
- Very hot: 4,800 W
- Minimum operating pressure: 10kPa

FU1114



- 3 temperatures:
- Cold: 0 W consumption
- Warm: 2,000 W
- Hot: 4,800 W
- Minimum operating pressure: 10kPa
- Water saving model

FU0936

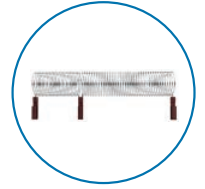

FU1115 / FU0937

*Do not connect your shower head directly to your electrical system. It must be connected separately.

ELECTRICAL SHOWER HEAD,

- Made of high resistance thermoplastic - Use 10 AWG cable for installation Minimum operating pressure: 10kPa - Frecuencia 60 Hz

Code	Product	Characteristics	Voltage	Current	Inner	Master
*FU1114	Adjustable to 4 temperatures	0 W to 4,800 W	120 V~	40 A	2	20
*FU0936	Adjustable to 3 temperatures	0 W to 4,800 W	120 V~	40 A	2	30
Spare resistance						
FU1115	Spare part (FU1114)	1,600 W to 4,800 W			10	200
FU0937	Spare part (FU0936)	2,000 W to 4,800 W			10	200

Type of packaging: Bag

NOM



FU0771 - FU0773



FU1610 - FU1613

- Made of polypropylene

NOM



- Practical and easy to use
- Cable length: #2, #3: 50 cm
- #4 - #9: 70 cm

NOM



EXHAUST FAN

- Sealed connection gas pipeline for better hermetic locking It can be installed on walls, windows and ceilings

Code	Size	Frame size for installation	Power	Air flow	Inner	Master
FU0771	4"	-	13 W	85 m ³ / hr	2	10
FU0772	5"	-	15 W	130 m ³ / hr	2	10
FU0773	6"	-	25 W	230 m ³ / hr	2	10
AIR EXTRACTOR						
FU1610	6"	17 cm	23 W	270 m ³ /hr	1	12
FU1611	8"	24 cm	28 W	510 m ³ /hr	1	12
FU1612	10"	28.5 cm	36 W	830 m ³ /hr	1	8
FU1613	12"	34 cm	43 W	1,100 m ³ /hr	1	6

Type of packaging: Box

SHOWER HEADS

Code	Measurement	Power	Capacity	Inner	Master
FP0017	#2	400 W	5 lts	20	200
FP0016	#3	480 W	8 lts	20	200
FP0015	#4	800 W	15 lts	10	200
FP0012	#5	900 W	18 lts	10	100
*FP0010	#6	1000 W	20 lts	10	100
*FP0011	#7	1200 W	25 lts	10	100
FP0014	#8	1500 W	30 lts	10	100
FP0013	#9	2000 W	35 lts	10	100

Type of packaging: Bag



FU9531

- Adjustable thermostat in each burner



FU9530

- Direct connection
- Polarized plug

ELECTRIC BURNER

- Polarized plug

Code	Characteristics	Power	Inner	Master
FU9531	2 burners	1,450 W	2	10
FU9530	1 burner	650 W	4	24

Type of packaging: Box

NOM





FU1013

SPECIFICATIONS	
Voltage	4.5 V
Frequency	315 Hz
Current	0.85 A
Control battery (included)	A23 of 12 V



FU1010

SPECIFICATIONS	
Voltage	4.5 V
Frequency	305 Hz
Control battery (included)	A23 of 12 V

WIRELESS DOORBELL - Made of ABS - 25 melodies - Distance of reach 100 m - Waterproof button - The bell uses 3 AA batteries (not included)

Code	Product	Sound level	Inner	Master
FU1013	2 controls, 1 battery-powered bell	70 - 90 db	2	48
FU1010	1 control, 1 lamp with batteries	70 - 90 db	2	48

Type of packaging: Blister



FU1012

SPECIFICATIONS	
Voltage	120 V-
Frequency	60 Hz
Current	100 mA
Control battery (included)	4.5 V-



FU1011

Bell uses 3 "AA" batteries (not included)

SPECIFICATIONS	
Voltage	4.5 V
Frequency	305 Hz
Control battery (included)	A23 of 12 V

WIRELESS DOORBELL - Made of ABS - 25 melodies - Distance of reach 100 m - Waterproof button

Code	Product	Sound level	Inner	Master
FU1012	1 control, 1 lamp with plug	70 - 90 db	2	48
FU1011	1 control, 1 lamp with batteries	70 - 90 db	2	48

Type of packaging: Blister



FU0332



FU0333



FU0334

RESIDENTIAL DING DONG SOUND DOORBELL

- Made of ABS - Two-toned

Voltage	Frequency	Current
120 V-	60 Hz	0.85 A

Code	Product	Sound level	Inner	Master
FU0332	Rectangular	70 - 90 db	6	60
FU0333	Square	70 - 90 db	6	60
FU0334	Wood finish	70 - 90 db	6	48

Type of packaging: Box



FU0796

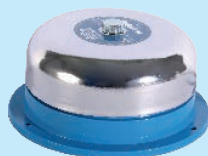

FU0132

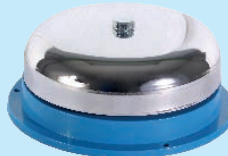

FU0133



FU0134



FU0135

BELL TYPE DOMESTIC DOORBELL

Chrome-plated bell Plastic base

Voltage	Frequency	Current
120 V-	60 Hz	0.30 A

Code	Measurement	Sound level	Inner	Master
FU0796	63.5 mm (2 1/2")	90 db	4	80
FU0132	101.6 mm (4")	90 db	4	32
FU0133	152.4 mm (6")	95 db	2	16
FU0134	203.2 mm (8")	95 db	2	16
FU0135	254 mm (10")	100 db	2	16

Type of packaging: Box



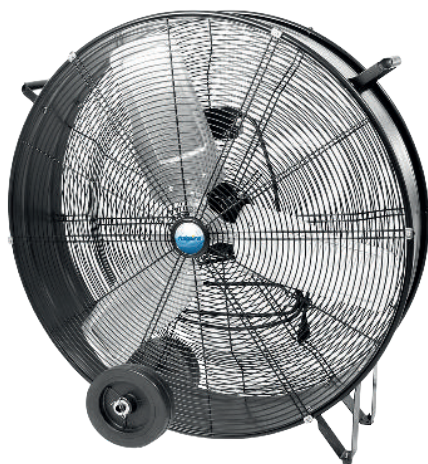

- Metal base with rubber wheels for easy movement
- Ideal for wineries, garages, workshops, hardware stores, etc.
- 2 speeds
- High impact resistant frame
- Metal blades

NOM



Voltage	Frequency	Weight
120 V~	60 Hz	16.7 kg

30" INDUSTRIAL DRUM FAN

Code	Power	RPM	CFM	Inner	Master
FU0985	340 W	1,060	9,800	1	1

Type of packaging: Box



- Metal base with rubber wheels for easy movement
- Ideal for wineries, garages, workshops, hardware stores, etc.
- 2 speeds
- High impact resistant frame
- Metal blades

NOM



Voltage	Frequency	Weight
120 V~	60 Hz	12.8 kg

24" INDUSTRIAL DRUM FAN

Code	Power	RPM	CFM	Inner	Master
FU0984	265 W	1100	8,500	1	1

Type of packaging: Box

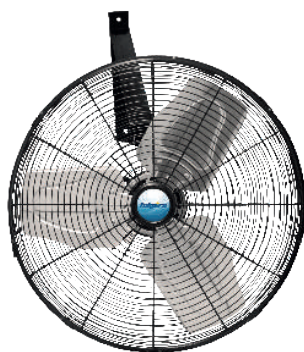

- Base for wall mounting
- Ideal for warehouses, garages, workshops, hardware stores, etc.
- 3 speeds
- High impact resistant frame
- Metal blades



*Foto ilustrativa

NOM



Voltage	Frequency	Weight
120 V~	60 Hz	8 kg

20" INDUSTRIAL FAN WALL

Code	Power	RPM	CFM	Inner	Master
FU1433	160W	1,550	5,100	1	1

Type of packaging: Box



Pedestal



Floor base



Wall Base



- Base: 3.25 kg for greater stability
- Metal cover and designed to have a long life
- 120 V ~ 60 Hz
- 2 speeds
- Safety grilles against high impact
- Metal blades
- **It has an oscillation system**

- Three positions of use: pedestal, floor and wall
- Light and easy to handle
- 3 speeds
- Metal blades
- **It has an oscillation system**



Voltage	Frequency
120 V~	60 Hz

Voltage	Frequency	Weight
120 V~	60 Hz	16.4 kg

3 IN 1 FAN 18"



Code	Power	RPM	Inner	Master
*FU9718	80 W	1,400	1	1

Type of packaging: Box

24" INDUSTRIAL DRUM FAN



Code	Power	RPM	CFM	Inner	Master
FU0986	215 W	1100	6,350	1	1

Type of packaging: Box



FU8401

- White enameled steel body
 - Reinforced and improved blades with greater thickness
 - 5-speed wall built in peripheral control:
- Speed 1 - 280 rpm
 Speed 2 - 260 rpm
 Speed 3 - 220 rpm
 Speed 4 - 185 rpm
 Speed 5 - 160 rpm



FU1432

- Made of polypropylene
- 5 speed control
- For wall mounting

56" HEAVY-DUTY CEILING FAN

Code	Power	RPM	Inner	Master
FU8401	95 W	280 - 160 rpm	1	1
FU1432	-	-	4	50

Type of packaging: Box

Voltage	Frequency
120 V~	60 Hz





YARDEN[®]

MIXERS

SHOWERS

CASINGS

HOSES

ANGULAR WRENCHES

VALVES



MIXERS

MIXER FOR ABS 4" BAR FAUCET



- Made of ABS
- Ceramic cartridge
- Aperture: 1/4" turn
- Weight: 220g
- Chrome finish
- Includes aereator
- Ideal for coastal areas or high humidity



Code	Handles	Inner	Master
YE0003	Gerber faucets	4	20
Spare parts			
YE0016	Cartridge of ABS (2 PCS)	1	250

Type of packaging: Box (YE0003) / Bag (YE0016)

MIXER FOR 4" ABS STRAIGHT FAUCET



- Made of ABS
- Ceramic cartridge
- Aperture: 1/4" turn
- Weight: 220g
- Chrome finish
- Includes aereator
- Ideal for coastal areas or high humidity



Code	Handles	Inner	Master
YE0001	Gerber faucets	4	20
Spare parts			
YE0016	Cartridge of ABS (2 PCS)	1	250

250Type of packaging: Box (YE) / Bag (YE0003)

MIXER FOR 4" CURVED FAUCET



- Made of ABS
- Ceramic cartridge
- Aperture: 1/4" turn
- Weight: 220g
- Chrome finish
- Includes aereator
- Ideal for coastal areas or high humidity.



Code	Handles	Inner	Master
YE0002	Gerber faucets	4	20
Spare parts			
YE0016	Cartridge of ABS (2 PCS)	1	250

Type of packaging: Box (YE0003) / Bag (YE0016)

MIXER FOR 8" ABS GOOSENECK FAUCET



- Made of ABS
- Ceramic cartridge
- Aperture: 1/4" turn
- Weight: 290g
- Chrome finish
- Includes aereator
- Ideal for coastal areas or high humidity



Code	Handles	Inner	Master
YE0004	Gerber faucets	4	24
Spare parts			
YE0016	Cartridge of ABS (2 PCS)	1	250

Type of packaging: Box (YE) / Bag (YE0003)

ANTISEDIMENT SHOWER HEAD TELEPHONE TYPE 2 1/2"



- Shower head made of ABS
- Includes zinc arm and flange
- Chrome finish
- 1.5 m hose



Code	Works with	Inner	Master
YE0015	Low pressure	2	24

Type of packaging: Box

ANTISEDIMENT 2 1/2"



- Shower head made of ABS
- Includes plastic arm and flange
- Chrome finish



Code	Works with	Inner	Master
YE0014	Low pressure	4	40

Type of packaging: Box

WATER-EFFICIENT SHOWER 2 1/2"



- Shower head made of ABS
- Includes plastic arm and flange



Code	Works with	Inner	Master
YE0012	Low and medium pressure	4	40

Type of packaging: Bag

WATER-EFFICIENT SHOWER 2"



- Shower head made of ABS
- Includes plastic arm and flange
- Chrome finish



Code	Works with	Inner	Master
YE0013	Low and medium pressure	10	40

Type of packaging: Bag



MIXER FOR 4" BAR FAUCET



- Brass body
- Stainless steel base plate and spout
- Zinc handles
- Ceramic cartridge
- Aperture: 1/4" turn
- Weight: 480g
- Chrome finish
- Includes aereator



Code	Handles	Inner	Master
YD0009	Lever	2	20
Spare parts			
YD0168	Brass cartridge (2 Pcs)	1	250

Type of packaging: Box (YD0009) / Bag (YD0168)

MIXER FOR 4" BAR FAUCET



- Brass body
- Stainless steel base plate and spout
- Zinc handles
- Ceramic cartridge
- Aperture: 1/4" turn
- Weight: 460g
- Chrome finish
- Includes aereator



Code	Handles	Inner	Master
YD0007	Gerber faucets	2	20
Spare parts			
YD0168	Brass cartridge (2 Pcs)	1	250

Type of packaging: Box (YD0007) / Bag (YD0168)

MIXER FOR 4" BAR FAUCET



- Brass body
- Stainless steel base plate and spout
- Acrylic handles
- Ceramic cartridge
- Aperture: 1/4" turn
- Weight: 460g
- Chrome finish
- Includes aereator



Code	Handles	Inner	Master
YD0008	Gerber faucets	2	20
Spare parts			
YD0168	Brass cartridge (2 Pcs)	1	250

Type of packaging: Box (YD0008) / Bag (YD0168)

MIXER FOR 4" STRAIGHT BATHROOM FAUCET



- Brass body
- Stainless steel base plate and spout
- Zinc handles
- Ceramic cartridge
- Aperture: 1/4" turn
- Weight: 525g
- Chrome finish
- Includes aereator



Code	Handles	Inner	Master
YD0003	Lever	2	20
Spare parts			
YD0168	Brass cartridge (2 Pcs)	1	250

Type of packaging: Box (YD0003) / Bag (YD0168)

MIXER FOR 4" STRAIGHT BATHROOM FAUCET



- Brass body
- Stainless steel base plate and spout
- Zinc handles
- Ceramic cartridge
- Aperture: 1/4" turn
- Weight: 515g
- Chrome finish
- Includes aereator



Code	Handles	Inner	Master
YD0001	Gerber faucets	2	20
Spare parts			
YD0168	Brass cartridge (2 Pcs)	1	250

Type of packaging: Box (YD0001) / Bag (YD0168)

MIXER FOR 4" STRAIGHT BATHROOM FAUCET



- Brass body
- Stainless steel base plate and spout
- Acrylic handles
- Ceramic cartridge
- Aperture: 1/4" turn
- Weight: 515g
- Chrome finish
- Includes aereator



Code	Handles	Inner	Master
YD0002	Gerber faucets	2	20
Spare parts			
YD0168	Brass cartridge (2 Pcs)	1	250

Type of packaging: Box (YD0002) / Bag (YD0168)

MIXER FOR 4" GOOSENECK BATHROOM FAUCET



- Brass body
- Stainless steel base plate and spout
- Zinc handles
- Ceramic cartridge
- Aperture: 1/4" turn
- Weight: 460g
- Chrome finish
- Includes aereator



Code	Handles	Inner	Master
YD0006	Lever	2	20
Spare parts			
YD0168	Brass cartridge (2 Pcs)	1	250

Type of packaging: Box (YD0006) / Bag (YD0168)

MIXER FOR 4" GOOSENECK BATHROOM FAUCET



- Brass body
- Stainless steel base plate and spout
- Zinc handles
- Ceramic cartridge
- Aperture: 1/4" turn
- Weight: 420g
- Chrome finish
- Includes aereator



Code	Handles	Inner	Master
YD0004	Gerber faucets	2	20
Spare parts			
YD0168	Brass cartridge (2 Pcs)	1	250

Type of packaging: Box (YD0004) / Bag (YD0168)

MIXER FOR 4" GOOSENECK BATHROOM FAUCET



- Brass body
- Stainless steel base plate and spout
- Acrylic handles
- Ceramic cartridge
- Aperture: 1/4" turn
- Weight: 440g
- Chrome finish
- Includes aereator



Code	Handles	Inner	Master
YD0005	Gerber faucets	2	20
Spare parts			
YD0168	Brass cartridge (2 Pcs)	1	250

Type of packaging: Box (YD0005) / Bag (YD0168)

MIXERS | INDIVIDUAL FAUCETS

MIXER FOR 8" COBRA KITCHEN FAUCET

Modus
YARDEN

- Brass body
- Stainless steel base plate and spout
- Zinc handles
- Ceramic cartridge
- Aperture: 1/4" turn
- Weight: 570g
- Chrome finish
- Includes aereator



Code	Handles	Inner	Master
YD0012	Lever	2	12
Spare parts			
YD0168	Brass cartridge (2 Pcs)	1	250

Type of packaging: Box (YD0012) / Bag (YD0168)

MIXER FOR 8" COBRA KITCHEN FAUCET

Modus
YARDEN

- Brass body
- Stainless steel base plate and spout
- Zinc handles
- Ceramic cartridge
- Aperture: 1/4" turn
- Weight: 570g
- Chrome finish
- Includes aereator



Code	Handles	Inner	Master
YD0010	Gerber faucets	2	12
Spare parts			
YD0168	Brass cartridge (2 Pcs)	1	250

Type of packaging: Box (YD0010) / Bag (YD0168)

MIXER FOR 8" COBRA KITCHEN FAUCET

Modus
YARDEN

- Brass body
- Stainless steel base plate and spout
- Acrylic handles
- Ceramic cartridge
- Aperture: 1/4" turn
- Weight: 570g
- Chrome finish
- Includes aereator



Code	Handles	Inner	Master
YD0011	Gerber faucets	2	12
Spare parts			
YD0168	Brass cartridge (2 Pcs)	1	250

Type of packaging: Box (YD0011) / Bag (YD0168)

MIXER FOR 8" GOOSENECK KITCHEN FAUCET

Modus
YARDEN

- Brass body
- Stainless steel base plate and spout
- Zinc handles
- Ceramic cartridge
- Aperture: 1/4" turn
- Weight: 550g
- Chrome finish
- Includes aereator



Code	Handles	Inner	Master
YD0015	Lever	2	24
Spare parts			
YD0168	Brass cartridge (2 Pcs)	1	250

Type of packaging: Box (YD0015) / Bag (YD0168)

MIXER FOR 8" GOOSENECK KITCHEN FAUCET

Modus
YARDEN

- Brass body
- Stainless steel base plate and spout
- Zinc handles
- Ceramic cartridge
- Aperture: 1/4" turn
- Weight: 550g
- Chrome finish
- Includes aereator



Code	Handles	Inner	Master
YD0013	Gerber faucets	2	24
Spare parts			
YD0168	Brass cartridge (2 Pcs)	1	250

Type of packaging: Box (YD0013) / Bag (YD0168)

MIXER FOR 8" GOOSENECK KITCHEN FAUCET

Modus
YARDEN

- Brass body
- Stainless steel base plate and spout
- Acrylic handles
- Ceramic cartridge
- Aperture: 1/4" turn
- Weight: 550g
- Chrome finish
- Includes aereator



Code	Handles	Inner	Master
YD0014	Gerber faucets	2	24
Spare parts			
YD0168	Brass cartridge (2 Pcs)	1	250

Type of packaging: Box (YD0014) / Bag (YD0168)

SINGLE HANDLE FOR SHORT GOOSENECK KITCHEN FAUCET

Modus
YARDEN

- Brass body
- Zinc handles
- Ceramic cartridge
- Aperture: 1/4" turn
- Weight: 365g
- Chrome finish



Code	Handles	Inner	Master
YD0018	Gerber faucets	4	24
Spare parts			
YD0168	Brass cartridge (2 Pcs)	1	250

Type of packaging: Box (YD0018) / Bag (YD0168)

SINGLE HANDLE FOR STRAIGHT KITCHEN FAUCET

Modus
YARDEN

- Brass body
- Zinc handles
- Ceramic cartridge
- Aperture: 1/4" turn
- Weight: 245g
- Chrome finish



Code	Handles	Inner	Master
YD0019	Gerber faucets	4	24
Spare parts			
YD0168	Brass cartridge (2 Pcs)	1	250

Type of packaging: Box (YD0019) / Bag (YD0168)

SET OF SINGLE HANDLE BATHROOM FAUCETS

Modus
YARDEN

- Brass body
- Zinc handles
- Ceramic cartridge
- Aperture: 1/4" turn
- Weight: 215g
- Chrome finish



Code	Handles	Inner	Master
YD0016	Gerber faucets	2	10
Spare parts			
YD0168	Brass cartridge (2 Pcs)	1	250

Type of packaging: Box (YD0016) / Bag (YD0168)

SET OF SINGLE HANDLE BATHROOM FAUCETS

Modus
YARDEN

- Brass body
- Acrylic handles
- Ceramic cartridge
- Aperture: 1/4" turn
- Weight: 225g
- Chrome finish



Code	Handles	Inner	Master
YD0017	Gerber faucets	2	10
Spare parts			
YD0168	Brass cartridge (2 Pcs)	1	250

Type of packaging: Box (YD0017) / Bag (YD0168)

SET OF ACRYLIC HANDLES FOR BATHROOM / KITCHEN SINK

- Made of acrylic
- Screws included



Code	Handles	Inner	Master
YD0023	Gerber faucets	4	24

Type of packaging: Box

LEVER HANDLE SET FOR BATHROOM / KITCHEN SINK

- Made of zinc
- Screws included
- Chrome finish



Code	Handles	Inner	Master
YD0024	Lever	4	24

Type of packaging: Box

SET OF METTALIC HANDLES FOR BATHROOM / KITCHEN SINK

- Made of zinc
- Screws included
- Chrome finish



Code	Handles	Inner	Master
YD0022	Gerber faucets	4	24

Type of packaging: Box

SET OF ABS HANDLES FOR BATHROOM / KITCHEN SINK

- Made of ABS
- Screws included
- Chrome finish



Code	Handles	Inner	Master
YD0021	Gerber faucets	4	24

Type of packaging: Box

TELEPHONE TYPE SHOWER HEAD 3"



- Shower head made of ABS
- Includes stainless steel arm and flange
- Chrome finish
- 1.5 m Hose



Code	Works with	Inner	Master
YD0142	Medium and high pressure	2	24

Type of packaging: Box

ROUND SHOWER HEAD 6"

- Shower head made of ABS
- Includes stainless steel arm and plastic flange
- Chrome finish



Code	Works with	Inner	Master
YD0144	low, medium and high pressure	2	24

Type of packaging: Box

SQUARE SHOWER HEAD 8"

- Shower head made of ABS
- Includes stainless steel arm and flange
- Chrome finish



Code	Works with	Inner	Master
YD0143	low, medium and high pressure	2	24

Type of packaging: Box

8" ROUND SHOWER

- Shower head made of stainless steel and ABS
- Arm not included
- Stainless steel flange
- Chrome finish

Use YD0152 arm



Code	Works with	Inner	Master
YD0145	low, medium and high pressure	2	32

Type of packaging: Box

8" SQUARE SHOWER HEAD

- Shower head made of stainless steel and ABS
- Arm not included
- Stainless steel flange
- Chrome finish

Use YD0152 arm



Code	Works with	Inner	Master
YD0146	low, medium and high pressure	4	32

Type of packaging: Box

2" ADJUSTABLE SHOWER

- Shower head Made of Zinc
- Includes zinc arm and stainless steel flange
- Chrome finish



Code	Works with	Inner	Master
YD0149	Low and medium pressure	2	40

Type of packaging: Box

3" 5-FUNCTION SHOWER HEAD

- Shower head made of ABS
- Includes stainless steel arm and flange
- Chrome finish



Code	Works with	Inner	Master
YD0141	Medium and high pressure	4	40

Type of packaging: Box

HANDLES | WALL-IN MIXERS



DISH LIKE SHOWER HEAD 3 1/2"



SQUARE SHOWER HEAD 2"

- Shower head made of zinc
- Includes stainless steel arm and flange
- Chrome finish

- Shower head Made of Zinc
- Includes stainless steel arm and flange
- Chrome finish



Code	Works with	Inner	Master
YD0147	Low and medium pressure	4	40

Type of packaging: Box

Code	Works with	Inner	Master
YD0148	Low and medium pressure	4	40

Type of packaging: Box

ARM AND FLANGE L TYPE

- Arm and flange made of stainless steel
- Measurement: 35 cm

ARM WITH FLANGE FOR SHOWER

- Arm and flange made of stainless steel



Code	Finish	Inner	Master
YD0152	Chromed	5	100

Type of packaging: Bag

Code	Finish	Inner	Master
YD0151	Chromed	10	200

Type of packaging: Bag

ARM WITH FLANGE FOR SHOWER

- Arm and flange made of ABS

SHOWER IN-WALL MIXER, COMPRESSION

- Made of brass
- Zinc handles and flange

1/4 SHOWER IN-WALL VALVE BODY

- Made of brass
- Zinc handles and flange



Code	Finish	Inner	Master
YD0150	Chromed	10	200

Type of packaging: Bag

Code	Inlet	Inner	Master
YD0133	1/2" thread	2	12

Spare parts			
YD0181	Brass cartridge (2 pcs)	1	100

Type of packaging: Box (YD0133) / Bag (YD0181)

Code	Inlet	Inner	Master
YD0134	1/2" thread	2	12

Spare parts			
YD0182	Brass cartridge (2 pcs)	1	100

Type of packaging: Box (YD0134) / Bag (YD0182)

FAUCET SET FOR WALL-IN VALVES, THREADED

- Made of brass
- Acrylic handles and Zinc flanges
- Compression closure

FAUCET SET FOR WALL-IN VALVES, THREADED

- Made of brass
- Gerber Faucets and Zinc flanges
- Compression closure

FAUCET SET FOR WALL-IN VALVES, THREADED

- Made of brass
- Compression closure



Code	Inlet	Inner	Master
YD0138	1/2"	2	50

Spare parts			
YD0183	Brass cartridge (2 pcs)	1	100

Type of packaging: Box (YD0138) / Bag (YD0183)

Code	Inlet	Inner	Master
YD0136	1/2"	2	50

Spare parts			
YD0183	Brass cartridge (2 pcs)	1	100

Type of packaging: Box (YD0136) / Bag (YD0183)

Code	Inlet	Inner	Master
YD0140	1/2"	2	50

Spare parts			
YD0183	Brass cartridge (2 pcs)	1	100

Type of packaging: Box (YD0140) / Bag (YD0183)

FACUCET SET FOR WALL-IN VALVES, WELDABLE

- Made of brass
- Acrylic Handles and zinc flanges
- Compression closure



Code	Inlet	Inner	Master
YD0137	1/2"	2	50
Spare parts			
YD0183	Brass cartridge (2 pcs)	1	100

Type of packaging: Box (YD0137) / Bag (YD0183)

FACUCET SET FOR WALL-IN, WELDABLE

- Made of brass
- Gerber Faucets and zinc flange
- Compression closure



Code	Inlet	Inner	Master
YD0135	1/2"	2	50
Spare parts			
YD0183	Brass cartridge (2 pcs)	1	100

Type of packaging: Box (YD0135) / Bag (YD0183)

FACUCET SET FOR WALL-IN VALVES, WELDABLE

- Made of brass
- Compression closure



Code	Inlet	Inner	Master
YD0139	1/2"	2	50
Spare parts			
YD0183	Brass cartridge (2 pcs)	1	100

Type of packaging: Box (YD0139) / Bag (YD0183)

RECESSED SINK 100 X 50 CM

- Made of stainless steel
- Satin finish
- Caliber 24
- Weight: 3.45 kg
- Length: 100 cm
- Width: 50 cm
- Depth: 15 cm
- Does not require cover to be installed, it is placed on a cabinet or fixed to the wall.



Code	Characteristic	Inner	Master
YD0125	Right drainer	1	5
YD0126	Left drainer	1	5

Type of packaging: Box

DOUBLE RECESSED SINK 84 X 56 CM

- Made of stainless steel
- Satin finish
- Caliber 24
- Weight: 3.6 kg
- Length: 84 cm
- Width: 56 cm
- Depth: 15 cm
- Easy installation, placed on the cover



Code	Characteristic	Inner	Master
YD0122	Double sink	5	5

Type of packaging: Box

RECESSED SINK 84 X 56 CM

- Made of stainless steel
- Satin finish
- Caliber 24
- Weight: 3.1 kg
- Length: 84 cm
- Width: 56 cm
- Depth: 15 cm
- Easy installation, it is placed on the cover



Code	Characteristic	Inner	Master
YD0123	Right drainer	5	5
YD0124	Left drainer	5	5

Type of packaging: Box

BAR TYPE RECESSED SINK 53 X 50 CM

- Made of stainless steel
- Satin finish
- Caliber 24
- Weight: 2.5 kg
- Length: 53 cm
- Width: 50 cm
- Depth: 15 cm
- Easy installation, it is placed on the cover



Code	Characteristic	Inner	Master
YD0127	Single sink	5	5

Type of packaging: Box

YARDEN SINK EXHIBITOR

- Structure made with PTR for sink support
- Steel sheet
- Electrostatic paint color black
- Digital printing on self-adhesive vinyl labeled on styrene
- Measurements:

Height: 170 cm
Width: 90 cm
Depth: 70 cm



*Product not included

Code	Capacity
YD0190	3 types of sinks

STAINLESS STEEL BASKET TRAP

- Stainless steel basket trap
- Brass pipe
- Detachable strainer
- Measurement: 1 1/2"



Code	Measurement	Inner	Master
YD0076	1 1/2"	6	60

Type of packaging: Box

PLASTIC BASKET TRAP

- Polypropylene basket trap.
- ABS tube
- Detachable strainer
- Measurement: 1 1/2"



Code	Measurement	Inner	Master
YD0077	1 1/2"	6	60

Type of packaging: Box

KITCHEN DRAIN PIPE WITHOUT TRAP

- Made of brass
- Chrome finish



Code	Measurement	Inner	Master
YD0060	1 1/2"	2	20

Type of packaging: Box

TRAPS | SINK PIPES

KITCHEN SINK DRAIN WITH BASKET TRAP

- Made of polypropylene
- Con tapa para limpieza



Code	Measurement	Inner	Master
YD0067	1 1/2"	4	24

Type of packaging: Bag

FLEXIBLE KITCHEN DRAIN PIPE WITH TRAP

- Made of polypropylene



Code	Handles	Inner	Master
YD0068	1 1/2"	4	24

Type of packaging: Bag

KITCHEN DRAIN PIPE, CHROME-COATED

- Made of polypropylene



Code	Measurement	Inner	Master
YD0072	1 1/2"	4	24

Type of packaging: Bag

P TYPE FLEXIBLE PIPE FOR KITCHEN SINK

- Made of polypropylene



Code	Measurement	Inner	Master
YD0070	1 1/2"	4	24

Type of packaging: Bag

DOUBLE KITCHEN SINK PIPE

- Made of polypropylene



Code	Measurement	Inner	Master
YD0069	1 1/2"	4	24

Type of packaging: Bag

KITCHEN SINK PIPE

- Made of polypropylene
- Chrome finish



Code	Measurement	Inner	Master
YD0075	1 1/2"	4	24

Type of packaging: Bag

KITCHEN DRAIN EXTENSION

- Made of copper



Code	Measurement	Length	Inner	Master
YD0065	1 1/2"	15 cm	5	50
YD0066	1 1/2"	20 cm	5	50

Type of packaging: Bulk

KITCHEN SINK PIPE EXTENSION

- Made of PVC



Code	Measurement	Length	Inner	Master
YD0191	1 1/2"	15 cm	25	150
YD0192	1 1/2"	20 cm	25	150

Type of packaging: Bulk

DRAIN PIPE WITH TRAP

- Made of brass
- Chrome finish
- Includes plug and chain



Code	Measurement	Inner	Master
YD0057	1 1/4"	2	20

Type of packaging: Box

DRAIN SYSTEM FOR BATHROOM FAUCET

- Made of brass
- Chrome finish
- Turnover plug



Code	Measurement	Inner	Master
YD0062	1 1/4"	2	20

Type of packaging: Box

SINK TRAP, WITH PLUG AND CHAIN

- Made of brass
- Chrome finish



Code	Measurement	Inner	Master
YD0061	1 1/4"	5	20

Type of packaging: Box

BATHROOM DRAIN PIPE WITHOUT TRAP

- Made of brass
- Chrome finish



Code	Measurement	Inner	Master
YD0059	1 1/4"	2	20

Type of packaging: Box

BATHROOM DRAIN PIPE WITHOUT TRAP

- Made of brass
- Chrome finish



Code	Measurement	Inner	Master
YD0058	1 1/4"	2	20

Type of packaging: Box

FLEXIBLE BATHROOM DRAIN PIPE 'P' TYPE

- Made of polypropylene



Code	Measurement	Inner	Master
YD0073	1 1/4"	4	24

Type of packaging: Bag

BATHROOM DRAIN PIPE, CHROME-COATED

- Made of polypropylene



Code	Measurement	Inner	Master
YD0074	1 1/4"	4	24

Type of packaging: Bag

BATHROOM SINK PIPE EXTENSION

- Made of brass
- Chrome finish



Code	Measurement	Length	Inner	Master
YD0063	1 1/4"	15 cm	10	50
YD0064	1 1/4"	20 cm	10	50

Type of packaging: Bulk

BATHROOM SINK PIPE EXTENSION

- Made of PVC



Code	Measurement	Length	Inner	Master
YD0193	1 1/4"	15 cm	25	200
YD0194	1 1/4"	20 cm	25	200

Type of packaging: Bulk

FLEXIBLE DRAIN PIPE

- Made of polypropylene



Code	Measurement	Inner	Master
YD0071	1 1/4" y 1 1/2"	4	24

Type of packaging: Bag

Mettalic lever for WC

- Steel rod
- Compatible with most WC



Code	Finish	Inner	Master
YD0177	Chromed	20	200

Type of packaging: Bag

TOILET FLAPPER

- Made of PVC
- Plastic chain and steel hook stainless



Code	Material	Inner	Master
YD0185	Rubber	20	20

Type of packaging: Bag

TOILET SCREW SET

- Made of bronze
- For toilet tank installation



Code	Length	Inner	Master
YD0184	2"	20	200
YD0179	2"	20	200

Type of packaging: Bag

TOILET BOWL WAX RING

- Seal leaks
- Prevents odor leaks



Code	Characteristics	Inner	Master
YD0162	Without guide	12	100
YD0161	With guide	12	48

Type of packaging: Box

TOILET SEAT

- Made of polypropylene
- Easy adjustment screws
- Round model



Code	Type	Color	Closed model	
			Inner	Master
YD0163	Open	White	5	15
YD0164	Open	Off-white	5	15
YD0165	Closed	White	5	15

Type of packaging: Bag

4" X 4" SQUARE METTALIC STRAINER

- Sink strainer made of zinc
- Stainless steel strainer
- Output diameter: 49mm
- Weight: 250g



Code	Strainer	Inner	Master
YD0130	Folding	5	50

Type of packaging: Box

HOSES | ANGULAR FAUCET

SINK METALLIC ROUND STRAINER 3 1/2"

- Sink strainer made of zinc
- Stainless steel strainer
- Output diameter: 44mm
- Weight: 250g



Code	Strainer	Inner	Master
YD0128	Fixed	5	100

Type of packaging: Box

SINK METALLIC ROUND STRAINER 3 1/2"

- Sink strainer made of zinc
- Stainless steel strainer
- Output diameter: 45mm
- Weight: 250g



Code	Strainer	Inner	Master
YD0129	Fixed	5	100

Type of packaging: Box

5" ABS COLANDER WITH LATERAL OUTPUT

- Colander made of ABS
- Chrome plastic grid
- Output diameter: 50mm
- Weight: 250g



Code	Strainer	Inner	Master
YD0131	Fixed	5	50

Type of packaging: Bulk

5" UNIVERSAL ROUND COLANDER

- Colander made of ABS
- Chrome plastic grid
- Output diameter: 50, 75 and 100 mm
- Weight: 250g



Code	Strainer	Inner	Master
YD0132	Fixed	5	50

Type of packaging: Bag

REINFORCED HOSE FOR GAS

- Made of PVC
- Tricapa
- Connectors nos included
- 50 m roll



*Price per roll

Code	Measurement	Maximum pressure	Wall thickness	Inner	Master
YD0153	3/8"	21 kg / cm ²	2.7 mm	1	1

Type of packaging: Roll

BRAIDED ALUMINUM FLEXIBLE HOSE FOR BOILER

- EPDM internal hose
- Brass spike
- Maximum pressure: 145 PSI



Code	Measurement	Length	Inner	Master
YD0037	3/4" x 1/2"	60 cm	6	72
YD0038	3/4" x 3/4"	60 cm	6	72

Type of packaging: Hanger

BRAIDED FLEXIBLE ALUMINUM HOSE FOR KITCHEN AND BATHROOM SINK

- EPDM internal hose
- Brass spike
- Maximum pressure: 145 PSI
- Maximum temperature: 80 °C



Code	Measurement	Length	Use	Inner	Master
YD0025	1/2" x 1/2"	40 cm	Bathroom sink	10	150
YD0026	1/2" x 1/2"	55 cm	Kitchen sink	10	150

Type of packaging: Hanger

FLEXIBLE BRAIDED HOSE ALUMINUM FOR WC

- EPDM internal hose
- Brass spike
- Maximum pressure: 145 PSI
- Maximum temperature: 80 °C



Code	Measurement	Length	Inner	Master
YD0027	1/2" x 7/8"	35 cm	10	150
YD0029	7/8" x 7/8"	35 cm	10	150
YD0028	1/2" x 7/8"	50 cm	10	150

Type of packaging: Hanger

FLEXIBLE FAUCET HOSE BRAIDED FLEXIBLE ALUMINUM FAUCET HOSE

- EPDM internal hose
- Metallic pin
- Maximum pressure: 90 PSI
- Maximum temperature: 60 °C



Code	Measurement	Length	Use	Inner	Master
YE0005	1/2" x 1/2"	40 cm	Bathroom sink	10	150
YE0006	1/2" x 1/2"	55 cm	Kitchen sink	10	150

Type of packaging: Hanger

FLEXIBLE HOSE BRAIDED ALUMINUM FOR WC



- EPDM internal hose
- Metallic pin
- Maximum pressure: 90 PSI
- Maximum temperature: 60 °C



Code	Measurement	Length	Inner	Master
YE0007	1/2" x 7/8"	35 cm	10	150

Type of packaging: Hanger

COMPRESSION ANGLE FAUCET 1/2" X 1/2" WITHOUT TRAP

- Made of brass
- NPT thread
- Nickel-plated finish
- ABS handle



Code	Maximum pressure	Inner	Master
YD0186	150 PSI	6	120

Type of packaging: Bulk

COMPRESSION ANGLE FAUCET 1/2" X 1/2" BARREL TYPE

- Made of brass
- NPT thread
- Nickel-plated finish
- ABS handle



Code	Maximum pressure	Inner	Master
YD0187	150 PSI	6	120

Type of packaging: Bulk

ANGLE FAUCET 1/4 TURN 1/2" X 1/2" WITHOUT TRAP

- Made of brass
- NPT thread
- Chrome finish
- ABS handle



See angled faucets in the section
Wolfax Page 159

Code	Maximum pressure	Inner	Master
YD0188	150 PSI	6	120

Type of packaging: Bulk

ANGLE FAUCET 1/4 TURN 1/2" X 1/2" BARREL TYPE

- Made of brass
- NPT thread
- Chrome finish
- ABS handle



See angled faucets in the section
Wolfax Page 159

Code	Maximum pressure	Inner	Master
YD0189	150 PSI	6	120

Type of packaging: Bulk

FLOAT VALVE

- Made of brass
- Maximum pressure: 200PSI



Code	Measurement	Weight	Inner	Master
YD0109	1/2"	172 g	10	100
YD0108	3/4"	235 g	8	80

Type of packaging: Bulk

THREADED GATE VALVE

- Made of brass
- Maximum pressure: 150PSI
- For water, oil and gas WOG (water, oil, gas)



Code	Measurement	Inner	Master
YD0084	1/2"	3	10
YD0085	3/4"	3	6
YD0086	1"	3	4

Type of packaging: Bag

THREADED WELDED BALL VALVE

- Made of brass
- Maximum pressure: 200PSI
- For water, oil and gas WOG (water, oil, gas)



Code	Measurement	Inner	Master
YD0096	1/2"	10	100
YD0097	3/4"	8	80
YD0098	1"	6	60

Type of packaging: Bag

THREADED GLOBE VALVE

- Made of brass
- Maximum pressure: 200PSI
- For water, oil and gas WOG (water, oil, gas)



Code	Measurement	Inner	Master
YD0078	1/2"	10	100
YD0079	3/4"	6	60
YD0080	1"	4	40

Type of packaging: Bag

WELDED GATE VALVE

- Made of brass
- Maximum pressure: 150PSI
- For water, oil and gas WOG (water, oil, gas)



Code	Measurement	Inner	Master
YD0087	1/2"	3	10
YD0088	3/4"	3	6
YD0089	1"	3	4

Type of packaging: Bag

WELDED BALL VALVE

- Made of brass
- Maximum pressure: 200PSI
- For water, oil and gas WOG (water, oil, gas)



Code	Measurement	Inner	Master
YD0099	1/2"	10	100
YD0100	3/4"	8	80
YD0101	1"	6	60

Type of packaging: Bag

WELDED GLOBE VALVE

- Made of brass
- Maximum pressure: 200PSI
- For water, oil and gas WOG (water, oil, gas)



Code	Measurement	Inner	Master
YD0081	1/2"	10	100
YD0082	3/4"	6	60
YD0083	1"	4	40

Type of packaging: Bag

SPRING RETENTION VALVE

- Made of brass
- Maximum pressure: 200PSI
- For water, oil and gas WOG (water, oil, gas)



Code	Measurement	Inner	Master
YD0105	1/2"	4	80
YD0106	3/4"	4	80
YD0107	1"	4	80

Type of packaging: Bag

SWING RETENTION VALVE

- Made of brass
- Maximum pressure: 200PSI
- For water, oil and gas WOG (water, oil, gas)



Code	Measurement	Inner	Master
YD0102	1/2"	2	100
YD0103	3/4"	2	80
YD0104	1"	2	60

Type of packaging: Bag

FOOT VALVE (PICHANCHA)

- Made of brass
- Maximum pressure: 200PSI



Code	Measurement	Inner	Master
YD0110	1/2"	4	100
YD0111	3/4"	4	80
YD0112	1"	4	60
YD0113	1 1/4"	4	48
YD0114	1 1/2"	4	36
YD0115	2"	4	24

Type of packaging: Bag

GARDEN FAUCET

PVC THREADED BALL VALVE

- Body and ball made of PVC
- ABS handle
- Maximum pressure: 150PSI



Code	Measurement	Inner	Master
YD0116	1/2"	24	240
YD0117	3/4"	20	200
YD0118	1"	8	128

Type of packaging: Bulk

PVC BALL VALVE

- Body and ball made of PVC
- ABS handle
- Maximum pressure: 150PSI



Code	Measurement	Inner	Master
YD0119	1/2"	24	240
YD0120	3/4"	20	200
YD0121	1"	8	128

Type of packaging: Bulk

GAS VALVE

- Made of brass
- Maximum pressure: 200 PSI
- 1/4 turn closure
- Threaded NPT input
- Flore output



Code	Inlet	Output	Inner	Master
YD0154	1/2"	5/16"	10	100
YD0155	1/2"	3/8"	10	100

Type of packaging: Bag

3/4" OUTDOOR VALVE

- Made of brass
- Weight: 160g
- Inlet: 3/4", 6 threads
- Outlet: 3/4", 5 threads



See garden valves **Wolfox** and **TOOLCRAFT** in page 93

Code	Measurement	Inner	Master
YD0052	3/4"	12	120

Type of packaging: Bulk

1/2" OUTDOOR VALVE

- Made of brass
- Weight: 140g
- Inlet: 1/2", 6 threads
- Outlet: 3/4", 5 threads



See garden valves **Wolfox** and **TOOLCRAFT** in page 93

Code	Measurement	Inner	Master
YD0053	1/2"	12	120

Type of packaging: Bulk

1/2" CHROMED OUTDOOR FAUCET

- Made of brass
- Weight: 130g
- Inlet: 1/2", 6 threads
- Outlet: 3/4", 4 threads



See garden valves **Wolfox** and **TOOLCRAFT** in page 93

Code	Measurement	Inner	Master
YD0054	1/2"	6	120

Type of packaging: Bulk

1/2" OUTDOOR NON-THREADED VALVE

- Made of brass
- Weight: 135g
- Inlet: 1/2", 6 threads



Code	Measurement	Inner	Master
YD0055	1/2"	6	120

Type of packaging: Bulk

1/2" OUTDOOR VALVE IN BLISTER

- Made of brass
- Weight: 100g
- Inlet: 1/2", 6 threads
- Outlet: 3/4", 4 threads



See garden valves **Wolfox** and **TOOLCRAFT** in page 93

Code	Measurement	Inner	Master
YE0009	1/2"	12	120

Type of packaging: Blister

1/2" BALL VALVE FOR OUTDOOR FAUCET

- Made of brass
- Weight: 130g
- Inlet: 1/2", 6 threads
- Outlet: 3/4", 4 threads



See garden valves **Wolfox** and **TOOLCRAFT** in page 93

Code	Measurement	Inner	Master
YD0056	1/2"	12	120

Type of packaging: Bulk

1/2" OUTDOOR VALVE

- Made of brass
- Weight: 100g
- Inlet: 1/2", 6 threads
- Outlet: 3/4", 4 threads



See garden valves **Wolfox** and **TOOLCRAFT** in page 93

Code	Measurement	Inner	Master
*YE0008	1/2"	12	120

Type of packaging: Bulk

1/2" OUTDOOR VALVE

- Made of polypropylene
- Weight: 43g
- Inlet: 1/2", 6 threads
- Outlet: 3/4", 5 threads



See garden valves **Wolfox** and **TOOLCRAFT** in page 93

Code	Measurement	Inner	Master
YE0011	1/2"	24	200

Type of packaging: Bulk

1/2" BALL VALVE FOR OUTDOOR FAUCET

- Made of zinc
- Weight: 110g
- Inlet: 1/2", 6 threads
- Outlet: 3/4", 4 threads



See garden valves **Wolfox** and **TOOLCRAFT** in page 93

Code	Measurement	Inner	Master
YE0010	1/2"	12	120

Type of packaging: Bulk



Top Forge[®]



HINGES

PADLOCKS

LATCHES

LOCKS



PINS

RAILS

HINGES

SQUARE HINGE, BRIGHT BRASS

- Made of steel.
- **Fixed pin with flat tip**
- For metal and wooden doors
- Each hinge includes 6 screws for installation



Greater Thickness

Code	Measurement	Thickness	Inner	Master
PF0104	2" x 2"	1.5 mm	20	100
PF0105	2 1/2" x 2 1/2"	1.7 mm	20	100
PF0106	3" x 3"	1.95 mm	20	100
PF0107	3 1/2" x 3 1/2"	2.2 mm	20	100
PF0108	4" x 4"	2.5 mm	20	100

Type of packaging: Bulk

SQUARE HINGE, ANTIQUE BRASS

- Made of steel.
- **Fixed pin with flat tip**
- For metal and wooden doors
- Each hinge includes 6 screws for installation



Greater Thickness

Code	Measurement	Thickness	Inner	Master
PF0109	2" x 2"	1.5 mm	20	100
PF0110	2 1/2" x 2 1/2"	1.7 mm	20	100
PF0111	3" x 3"	1.95 mm	20	100
PF0112	3 1/2" x 3 1/2"	2.2 mm	20	100
PF0113	4" x 4"	2.5 mm	20	100

Type of packaging: Bulk

SQUARE HINGE, MATTE CHROME

- Made of steel.
- **Fixed pin with flat tip**
- For metal and wooden doors
- Each hinge includes 6 screws for installation



Greater Thickness

Code	Measurement	Thickness	Inner	Master
PF0114	2" x 2"	1.5 mm	20	100
PF0115	2 1/2" x 2 1/2"	1.7 mm	20	100
*PF0116	3" x 3"	1.95 mm	20	100
PF0117	3 1/2" x 3 1/2"	2.2 mm	20	100
PF0118	4" x 4"	2.5 mm	20	100

Type of packaging: Bulk

SQUARE HINGE

- Made of steel.
- **Fixed pin with flat tip**
- For metal and wooden doors
- Each hinge includes 6 screws for installation



Greater Thickness



Blister 2 pieces

*Price per blister

Code	Measurement	Finish	Thickness	Inner	Master
PF0119	3" x 3"	Matte chrome	1.95 mm	20	100
PF0120	3" x 3"	Bright brass	1.95 mm	20	100
PF0121	3" x 3"	Antique brass	1.95 mm	20	100

Type of packaging: Blister

SQUARE HINGE, FIXED PIN

- Made of steel.
- **Fixed pin with flat tip**
- For wooden doors
- Each hinge includes 6 screws for installation

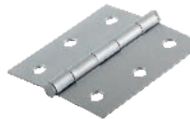

Price per piece

Code	Measurement	Finish	Thickness	Inner	Master
PF0122	3" x 3"	Matte chrome	1.55 mm	20	200
PF0123	3" x 3"	Bright brass	1.55 mm	20	200
PF0124	3" x 3"	Antique brass	1.55 mm	20	200

Type of packaging: Bulk

CHROME HINGE, LOOSE PIN

- Made of steel.
- **Loose pin with flat head**
- For wooden doors
- Each hinge includes 6 screws for installation



Price per piece

Code	Measurement	Finish	Thickness	Inner	Master
*PF0125	3" x 3"	Matte chrome	1.55 mm	20	200
PF0126	3" x 3"	Bright brass	1.55 mm	20	200
PF0127	3" x 3"	Antique brass	1.55 mm	20	200

Type of packaging: Bulk

DOUBLE ACTION DOOR HINGE

- Steel body
- Adjustable springs regulate opening and closing force
- Allows the door to open in both directions
- **Load capacity: 30 kg**
- For door thickness: 1 1/4" to 1 3/4"

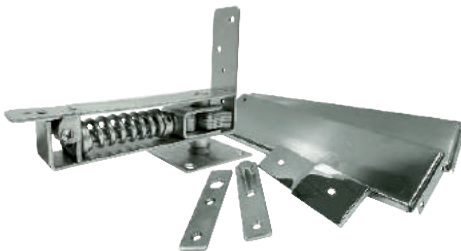

Code	Finish	Inner	Master
PF0239	Bright chrome	2	12
PF0240	Bright brass	2	12

Type of packaging: Box

TWO-DIMENSIONAL HINGE

- Made of steel
- Screws for installation included

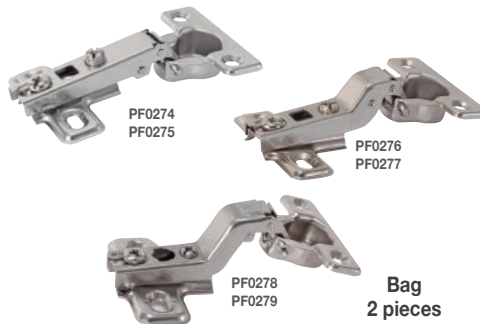

PF0274
PF0275

PF0276
PF0277

PF0278
PF0279

Bag 2 pieces
Price per bag

Code	Characteristics	Inset	Inner	Master
PF0274	Straight	26 mm	20	120
PF0275	Straight	32 mm	20	120
PF0276	Semi curve	26 mm	20	120
PF0277	Semi curve	32 mm	20	120
PF0278	Curve	26 mm	20	120
PF0279	Curve	32 mm	20	120

Type of packaging: Bag

COMBINATION LUGGAGE PADLOCK

- Body and metal hook
- The combination can be customized (3 figures)



PF0173



PF0174



Cut-resistant hook

Code	Measurement	Inner	Master
PF0173	25 mm	12	360
PF0174	35 mm	12	360

Type of packaging: Blister

BRASS SLIDING BOLD PADLOCK

- Brass cylinder with 5 pins
- Cut-resistant steel hook
- 3 keys

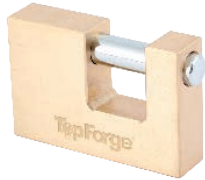

Code	Measurement	Type of key	Inner	Master
PF0156	75 mm	Traditional	2	36
PF0157	75 mm	Tetra	12	36

Type of packaging: Blister

IRON SLIDING BOLD PADLOCK

- Metallic cylinder
- Cut-resistant steel hook
- 3 keys



Code	Measurement	Type of key	Inner	Master
PF0158	70 mm	Traditional	6	24
PF0159	70 mm	Tetra	6	24

Type of packaging: Blister

BRASS PADLOCK

- Brass cylinder
- Cut-resistant steel hook
- 3 keys (PF0128 and PF0129 include 4 keys)



Code	Hook	Measurement	Inner	Master
PF0130	Short	30 mm	6	72
PF0131	Long	30 mm	6	72
*PF0132	Short	40 mm	6	72
PF0133	Long	40 mm	6	72
PF0134	Short	50 mm	6	36
PF0135	Long	50 mm	6	36
2-piece set				
PF0128	Short	20 mm	4	16
PF0129	Short	40 mm	4	16

Type of packaging: Blister

LAMINATED PADLOCK

- Brass cylinder
- Cut-resistant steel hook
- 3 keys (PF0140 includes 4 keys)



Code	Hook	Measurement	Inner	Master
PF0136	Short	30 mm	12	96
PF0137	Short	40 mm	12	72
PF0138	Short	50 mm	6	60
2-piece set				
PF0139	Short	40 mm	6	48
4-piece set				
PF0140	Short	40 mm	4	24

Type of packaging: Blister

IRON PADLOCK

- Brass cylinder
- Cut-resistant steel hook
- 3 keys (2-piece set includes 4 keys) (4-piece set includes 6 keys)



Code	Hook	Measurement	Inner	Master
PF0200	Short	30 mm	12	72
PF0201	Long	30 mm	12	72
*PF0141	Short	40 mm	12	72
PF0142	Long	40 mm	12	72
PF0143	Short	50 mm	6	72
PF0144	Long	50 mm	6	72
2-piece set				
PF0146	Short	40 mm	6	36
PF0147	Long	40 mm	6	36
PF0148	Short	50 mm	4	36
PF0149	Long	50 mm	4	36
4-piece set				
PF0145	Short	40 mm	4	36

Type of packaging: Blister

IRON PADLOCK, IN BOX

- Brass cylinder
- Cut-resistant steel hook
- 3 keys



Code	Hook	Measurement	Inner	Master
PF0150	Short	30 mm	12	72
PF0151	Long	30 mm	12	72
PF0152	Short	40 mm	12	72
PF0153	Long	40 mm	12	72
PF0154	Short	50 mm	6	72
PF0155	Long	50 mm	6	72

Type of packaging: Box

COMBINATION PADLOCK

- Cut-resistant steel body and hook
- Fixed combination of 3 figures



Code	Measurement	Inner	Master
PF0172	50 mm	12	72

Type of packaging: Blister

BRASS COLOR IRON PADLOCK

- Metallic cylinder
- Cut-resistant steel hook
- 3 keys
- Antique brass finish



Code	Hook	Measurement	Inner	Master
PF0176	Short	30 mm	12	48
PF0177	Long	30 mm	12	48
PF0178	Short	40 mm	12	48
PF0179	Long	40 mm	12	36
PF0180	Short	50 mm	12	36
PF0181	Long	50 mm	12	36
2-piece set				
PF0175	Short	20 mm	12	48

Type of packaging: Blister

GREY COLOR IRON PADLOCK

- Metallic cylinder
- Cut-resistant steel hook
- 3 keys
- Grey finish

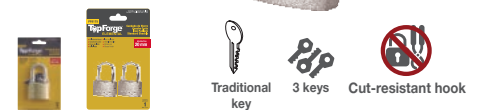

Code	Hook	Measurement	Inner	Master
PF0183	Short	30 mm	12	48
PF0184	Long	30 mm	12	48
PF0185	Short	40 mm	12	48
PF0186	Long	40 mm	12	36
PF0187	Short	50 mm	12	36
PF0188	Long	50 mm	12	36
2-piece set				
PF0182	Short	20 mm	12	48

Type of packaging: Blister

LOCKS

RIM DEADLOCK, SLIDING DOOR, CLASSIC

- Solid brass cylinder
- 2 brass keys



Code	Type	Model	Inner	Master
PF0015	Classic	Right	2	24
PF0016	Classic	Left	2	24

Type of packaging: Box

RIM DEADLOCK, SLIDING DOOR, EASY INSTALLATION

- Solid brass cylinder
- 2 brass keys



Code	Type	Model	Inner	Master
PF0013	Easy to install	Right	2	24
PF0014	Easy to install	Left	2	24

Type of packaging: Box

RIM DEADLOCK, SLIDING DOOR, DEADBOLT

- Solid brass cylinder
- 2 brass keys

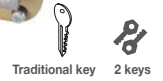
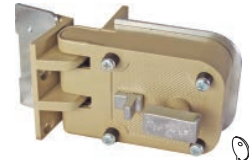

Code	Type	Model	Inner	Master
PF0017	Deadbolt cylinder	Right	2	24
PF0018	Deadbolt cylinder	Left	2	24

Type of packaging: Box

RIM DEADLOCK, TETRA KEY

- Solid brass cylinder
- 2 keys

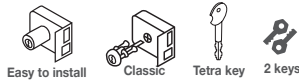

Code	Type	Model	Inner	Master
PF0011	Classic	Right	3	24
PF0012	Classic	Left	3	24
PF0005	Easy to install	Right	3	24
PF0006	Easy to install	Left	3	24

Type of packaging: Blister

RIM DEADLOCK, STANDARD KEY

- Solid brass cylinder
- 2 brass keys

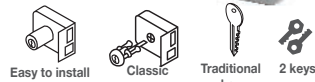

Code	Type	Model	Inner	Master
PF0009	Classic	Right	3	24
PF0010	Classic	Left	3	24
PF0003	Easy to install	Right	3	24
PF0004	Easy to install	Left	3	24

Type of packaging: Blister

RIM DEADLOCK, STANDARD KEY

- Solid brass cylinder
- 2 brass keys

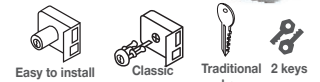

Code	Type	Model	Inner	Master
PF0007	Classic	Right	3	24
PF0008	Classic	Left	3	24
PF0001	Easy to install	Right	3	24
PF0002	Easy to install	Left	3	24

Type of packaging: Box

RIM DEAD LOCK, TETRA KEY

- Brass cylinder
- 2 keys



Code	Type	Model	Inner	Master
PF0023	Free bar	Right	3	24
PF0024	Free bar	Left	3	24
PF0029	Fixed bar	Right	3	24
PF0030	Fixed bar	Left	3	24

Type of packaging: Blister

KEYED BOLT, TRADITIONAL KEY

- Brass cylinder
- 2 brass keys

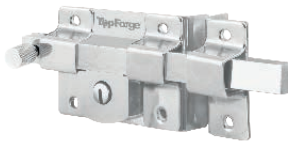

Code	Type	Model	Inner	Master
PF0021	Free bar	Right	3	24
PF0022	Free bar	Left	3	24
PF0027	Fixed bar	Right	3	24
PF0028	Fixed bar	Left	3	24

Type of packaging: Blister

KEYED BOLT, TRADITIONAL KEY

- Brass cylinder
- 2 brass keys



Code	Type	Model	Inner	Master
PF0019	Free bar	Right	3	24
PF0020	Free bar	Left	3	24
*PF0025	Fixed bar	Right	3	24
*PF0026	Fixed bar	Left	3	24

Type of packaging: Box

RIM BAR LOCK, DOUBLE CYLINDER, TRADITIONAL KEY

- Solid brass cylinder
- It can be left and right
- 2 brass keys

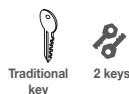

Code	Type	Model	Inner	Master
PF0031	Free bar	Left/Right	2	12

Type of packaging: Box

FIXED BAR LOCK, EXTERIOR CYLINDER TRADITIONAL KEY

- Solid brass cylinder
- It can be left and right
- 2 brass keys

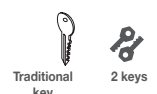

Code	Type	Model	Inner	Master
PF0032	Fixed bar	Left/Right	2	12

Type of packaging: Box

BALL LOCK KNOB, CYLINDRICAL MECHANISM

- Cylindrical mechanism
- Brass cylinder
- 2 keys included for entry / bedroom knobs



Traditional key

Code	Function	Knob (outside / inside)	Finish	Inner	Master
PF0033	Entry point	Key / plain	Bright brass	3	24
PF0036	Bedroom	Key / button	Bright brass	3	24
PF0039	Bathroom	Keyhole / button	Bright brass	3	24
PF0034	Entry point	Key / plain	Antique brass	3	24
PF0037	Bedroom	Key / button	Antique brass	3	24
PF0040	Bathroom	Keyhole / button	Antique brass	3	24
PF0035	Entry point	Key / plain	Matte chrome	3	24
★PF0038	Bedroom	Key / button	Matte chrome	3	24
★PF0041	Bathroom	Keyhole / button	Matte chrome	3	24

Packing type: Blister

BELL LOCK KNOB, CYLINDRICAL MECHANISM

- Cylindrical mechanism
- Brass cylinder
- 2 keys included for entry / bedroom knobs



Traditional key

Code	Function	Knob (outside / inside)	Finish	Inner	Master
PF0042	Entry point	Key / plain	Bright brass	3	24
PF0045	Bedroom	Key / button	Bright brass	3	24
PF0048	Bathroom	Keyhole / button	Bright brass	3	24
PF0043	Entry point	Key / plain	Antique brass	3	24
PF0046	Bedroom	Key / button	Antique brass	3	24
PF0049	Bathroom	Keyhole / button	Antique brass	3	24
PF0044	Entry point	Key / plain	Matte chrome	3	24
PF0047	Bedroom	Key / button	Matte chrome	3	24
PF0050	Bathroom	Keyhole / button	Matte chrome	3	24

Packing type: Blister

OVAL LOCK KNOB, CYLINDRICAL MECHANISM

- Cylindrical mechanism
- Brass cylinder
- 2 keys included for entry / bedroom knobs



Traditional key

Code	Function	Knob (outside / inside)	Finish	Inner	Master
PF0051	Entry point	Key / plain	Bright brass	3	24
PF0054	Bedroom	Key / button	Bright brass	3	24
PF0057	Bathroom	Keyhole / button	Bright brass	3	24
PF0052	Entry point	Key / plain	Antique brass	3	24
PF0055	Bedroom	Key / button	Antique brass	3	24
PF0058	Bathroom	Keyhole / button	Antique brass	3	24
PF0053	Entry point	Key / plain	Matte chrome	3	24
PF0056	Bedroom	Key / button	Matte chrome	3	24
PF0059	Bathroom	Keyhole / button	Matte chrome	3	24

Packing type: Blister

STRAIGHT HANDLE LOCK

- Tubular mechanism
- Brass cylinder
- 3 keys included for entry / bedroom knobs



Traditional key

3 keys

Code	Function	Knob (outside / inside)	Finish	Inner	Master
PF0060	Entry / Bedroom	Key / button	Bright brass	3	20
PF0061	Entry / Bedroom	Key / button	Antique brass	3	20
PF0062	Entry / Bedroom	Key / button	Matte chrome	3	20
PF0063	Bathroom	Keyhole / button	Bright brass	3	20
PF0064	Bathroom	Keyhole / button	Antique brass	3	20
PF0065	Bathroom	Keyhole / button	Matte chrome	3	20

Type of packaging: Blister

CURVED HANDLE LOCK

- Tubular mechanism
- Brass cylinder
- 3 keys included for entry / bedroom knobs

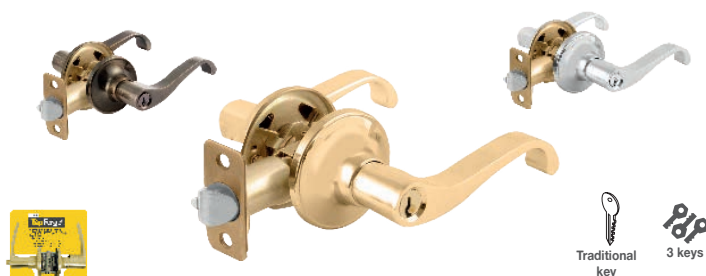

Traditional key

3 keys

Code	Function	Knob (outside / inside)	Finish	Inner	Master
PF0066	Entry / Bedroom	Key / button	Bright brass	3	20
PF0067	Entry / Bedroom	Key / button	Antique brass	3	20
PF0068	Entry / Bedroom	Key / button	Matte chrome	3	20
PF0069	Bathroom	Keyhole / button	Bright brass	3	20
PF0070	Bathroom	Keyhole / button	Antique brass	3	20
PF0071	Bathroom	Keyhole / button	Matte chrome	3	20

Type of packaging: Blister

HARTFORD HANDLE LOCK

- Tubular mechanism
- Brass cylinder
- Entry / bedroom locks, includes 3 keys



Traditional key

3 keys

Code	Function	Knob (outside / inside)	Finish	Inner	Master
PF0072	Entry / Bedroom	Key / button	Matte chrome	3	20
PF0073	Bathroom	Keyhole / button	Matte chrome	3	20

Type of packaging: Blister

LOCKS | KNOBS

BALL DOOR KNOB, CYLINDRICAL MECHANISM

- Cylindrical mechanism
- Metallic cylinder
- 2 keys included for entry / bedroom



Traditional key

Code	Function	Knob (outside / inside)	Finish	Inner	Master
PF0080	Entry / bedroom	Key / button	Bright brass	3	24
PF0083	Bathroom	Keyhole / button	Bright brass	3	24
PF0081	Entry / bedroom	Key / button	Antique brass	3	24
PF0084	Bathroom	Keyhole / button	Antique brass	3	24
PF0082	Entry / bedroom	Key / button	Matte chrome	3	24
PF0085	Bathroom	Keyhole / button	Matte chrome	3	24

Type of packaging: Box

BALL DOOR KNOB, TUBULAR MECHANISM

- Tubular mechanism
- Metallic cylinder
- 2 keys included for entry / bedroom



Traditional key

Code	Function	Knob (outside / inside)	Finish	Inner	Master
PF0086	Entry / bedroom	Key / button	Bright brass	3	24
PF0089	Bathroom	Keyhole / button	Bright brass	3	24
PF0087	Entry / bedroom	Key / button	Antique brass	3	24
PF0090	Bathroom	Keyhole / button	Antique brass	3	24
PF0088	Entry / bedroom	Key / button	Matte chrome	3	24
PF0091	Bathroom	Keyhole / button	Matte chrome	3	24

Type of packaging: Box

DOUBLE CYLINDER LOCK

- Steel shield
- Brass cylinder
- Includes 2 brass keys



Interior side of the lock

Traditional key
2 keys

Code	Finish	Inner	Master
PF0077	Bright brass	3	24
PF0078	Antique brass	3	24
PF0079	Matte chrome	3	24

Type of packaging: Blister

DEADBOLT CYLINDER LOCK

- Steel shield
- Brass cylinder
- Includes 2 brass keys

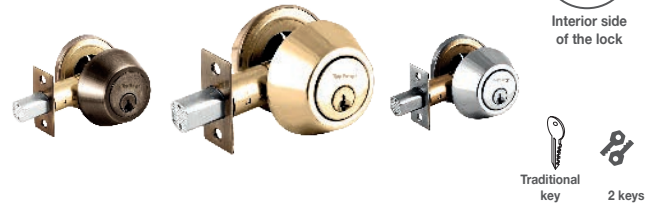

Interior side of the lock

Traditional key
2 keys

Code	Finish	Inner	Master
PF0074	Bright brass	3	24
PF0075	Antique brass	3	24
PF0076	Matte chrome	3	24

Type of packaging: Blister

DOUBLE CYLINDER LOCK

- Steel shield
- Metallic cylinder
- 2 keys



Interior side of the lock

Traditional key
Includes 2 keys

Code	Finish	Inner	Master
PF0095	Bright brass	3	24
PF0096	Antique brass	3	24
PF0097	Matte chrome	3	24

Type of packaging: Box

DEADBOLT

- Steel shield
- Metallic cylinder
- 2 keys



Interior side of the lock

Traditional key
Includes 2 keys

Code	Finish	Inner	Master
PF0092	Bright brass	3	24
PF0093	Antique brass	3	24
PF0094	Matte chrome	3	24

Type of packaging: Box

KNOB AND DEADBOLT SET DOUBLE CYLINDER

- Steel knob and shield
- Knob with cylindrical mechanism
- Metallic cylinder
- Both open with the same key
- 2 keys
- Knob: exterior with key / interior with button



Interior side of the lock

Traditional key
Includes 2 keys

Code	Finish	Inner	Master
PF0101	Bright brass	2	24
PF0102	Antique brass	2	24
PF0103	Matte chrome	2	24

Type of packaging: Box

KNOB AND DEADBOLT SET DEADBOLT

- Steel knob and shield
- Knob with cylindrical mechanism
- Metallic cylinder
- Both open with the same key
- 2 keys
- Knob: exterior with key / interior with button

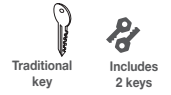

Code	Finish	Inner	Master
PF0098	Bright brass	2	24
PF0099	Antique brass	2	24
PF0100	Matte chrome	2	24

Type of packaging: Box

VIENNA HANDLE SET DOOR LOCK DOUBLE CYLINDER

- Steel shield
- Brass cylinder
- METALLIC BODY
- Includes 3 brass keys

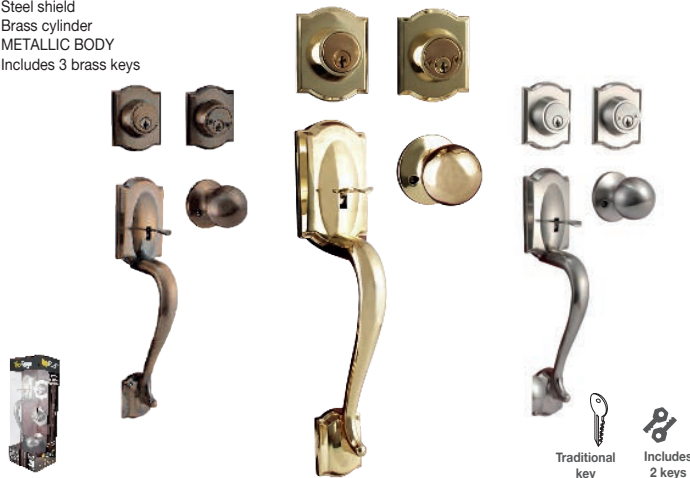

Code	Finish	Inner	Master
PF0194	Bright brass	1	6
PF0195	Antique brass	1	6
PF0196	Matte chrome	1	6

Type of packaging: Box

VALIANT HANDLE SET DOOR LOCK DOUBLE CYLINDER

- Steel shield
- Brass cylinder
- METALLIC BODY
- Includes 3 brass keys



Code	Finish	Inner	Master
PF0189	Bright brass	1	6
PF0190	Antique brass	1	6
PF0191	Matte chrome	1	6

Type of packaging: Box

ROYAL HANDLE SET DOOR LOCK DOUBLE CYLINDER

- Steel shield
- Brass cylinder
- METALLIC BODY
- Includes 3 brass keys

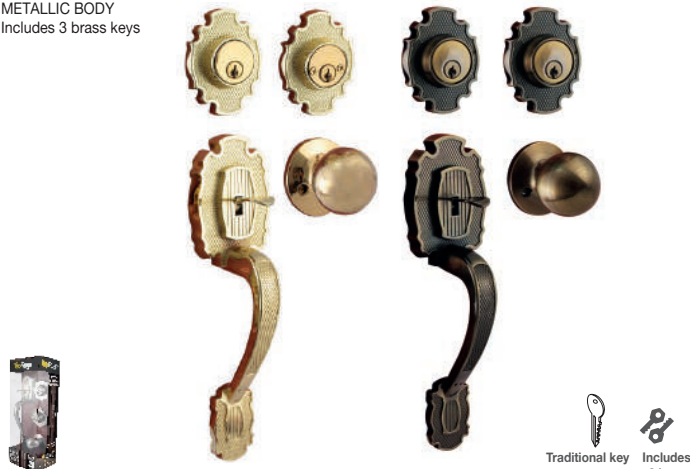

Code	Finish	Inner	Master
PF0192	Bright brass	1	6
PF0193	Antique brass	1	6

Type of packaging: Box

MONACO HANDLE SET DOOR LOCK DEADBOLT

- Steel shield
- Brass cylinder
- METALLIC BODY
- Includes 3 brass keys



Code	Finish	Inner	Master
PF0197	Bright brass	1	6
PF0198	Antique brass	1	6
PF0199	Matte chrome	1	6

Type of packaging: Box

PINS | HASPS | STOPS

DOOR CHAIN GUARD

- METALLIC BODY
- Spring button
- Screws for installation included

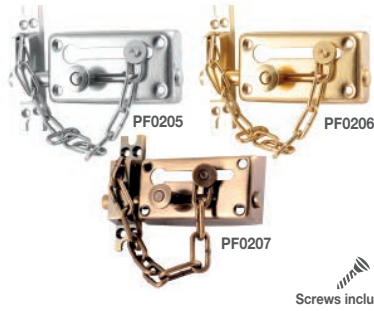

Screws included

Code	Finish	Inner	Master
PF0205	Chrome	6	36
PF0206	Polished brass	6	36
PF0207	Antique brass	6	36

Type of packaging: Blister

SECURITY DOOR FASTENER

- METALLIC BODY
- Screws for installation included



Screws included

Code	Finish	Inner	Master
PF0202	Chrome	6	36
PF0203	Polished brass	6	36
PF0204	Antique brass	6	36

Type of packaging: Blister

HASPS

- Brass finish
- Screws for installation included

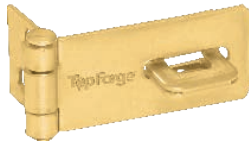

Code	Length	Inner	Master
PF0270	1 3/4"	12	120
PF0271	2 1/2"	12	120
PF0272	3 1/2"	12	120
PF0273	4 1/2"	12	120

Type of packaging: Blister

SURFACE BOLT

- METALLIC BODY
- Threaded button
- Vertical and horizontal installation
- Screws for installation included



Screws included

Code	Finish	Measurement	Inner	Master
PF0208	Chrome	2 1/2"	6	36
PF0209	Chrome	4 1/4"	6	36
PF0210	Chrome	5 1/2"	6	36
PF0211	Polished brass	2 1/2"	6	36
PF0212	Polished brass	4 1/4"	6	36
PF0213	Polished brass	5 1/2"	6	36

Type of packaging: Blister

HASPS

- Zinc plated finish
- Screws for installation included

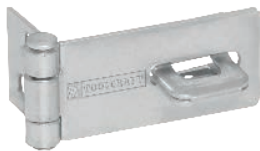

Code	Length	Inner	Master
PF0266	1 3/4"	12	48
PF0267	2 1/2"	12	48
PF0268	3 1/2"	12	48
PF0269	4 1/2"	12	48

Type of packaging: Blister

DOOR SWEEP

- Made of aluminum and PVC rubber
- For all types of doors
- Blocks out smoke, dust, light, etc.
- Screws for installation included

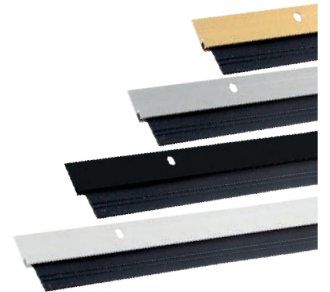

Code	Finish	Measurement	Inner	Master
PF0225	Aluminum	1 m	10	100
PF0226	Gold	1 m	10	100
PF0227	White	1 m	10	100
PF0228	Black	1 m	10	100

Type of packaging: Hanger

ELBOW DOOR STOP

- METALLIC BODY
- Rubber bumper
- Protect doors and walls
- Screws for installation included



Code	Finish	Inner	Master
PF0221	Chrome	6	36
PF0222	Polished brass	6	36

Type of packaging: Blister

FLOOR DOOR STOP

- Metallic body
- Rubber bumper
- Protect doors and walls
- Screws for installation included



Code	Finish	Inner	Master
PF0219	Chrome	6	36
PF0220	Polished brass	6	36

Type of packaging: Blister

SOLID DOOR STOP

- METALLIC BODY
- Rubber bumper
- Protect walls and doors



Code	Finish	Inner	Master
PF0223	Chrome	6	36
PF0224	Polished brass	6	36

Type of packaging: Blister

Type of packaging: Blister

- METALLIC BODY
- Anti-slip rubber
- Screws for installation included



Code	Finish	Inner	Master
PF0217	Chrome	6	36
PF0218	Polished brass	6	36

Type of packaging: Blister

LENS DOOR VIEWER

- Brass body
- Glass lens
- For 1 3/8" to 2 3/16" thickness door
- 180° degree visibility



Code	Finish	Inner	Master
PF0214	Bright brass	6	24
PF0215	Antique brass	6	24
PF0216	Matte chrome	6	24

Type of packaging: Blister

CLOSET DOOR LOCK

- METALLIC BODY
- Metallic cylinder
- 2 steel keys
- Screws for installation included

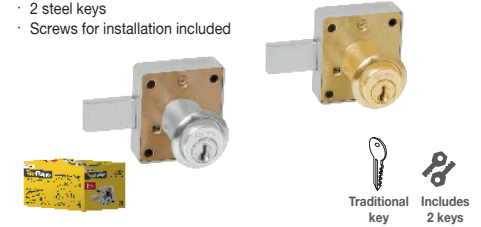

Code	Finish	Measurement	Inner	Master
PF0233	Chrome	29 mm	6	36
PF0234	Brass	29 mm	6	36
PF0235	Chrome	36 mm	6	36
PF0236	Brass	36 mm	6	36

Type of packaging: Box

SLIDING DOOR LOCK

- Solid brass deadbolt
- Zinc plate
- Metallic cylinder
- Pin system
- Push button mechanism
- 2 brass keys included
- Screws for installation included



Code	Finish	Inner	Master
PF0231	Chrome	6	72
PF0232	Brass	6	72

Type of packaging: Box

DRAWER LOCK

- METALLIC BODY
- Metallic cylinder
- 2 brass keys included
- Screws for installation included



Code	Finish	Inner	Master
PF0229	Chrome	6	144
PF0230	Brass	6	144

Type of packaging: Box

VERTICAL FURNITURE LOCK

- METALLIC BODY
- Vertical action lock
- Includes 2 brass keys



Code	Finish	Inner	Master
PF0237	Brass	6	72
PF0238	Chrome	6	72

Type of packaging: Blister

LOCKING SLIDES SOFT CLOSE

- Made of steel
- Nickel-plated finish
- Bearing mechanism
- 3-section slider
- Soft spring closure
- Load capacity per slide set: 30 kg



Bag
2 pieces
Price per bag

Code	Measurement	Inner	Master
PF0255	40 cm (16")	5	15
PF0256	45 cm (18")	5	15
PF0257	50 cm (20")	5	15
PF0258	55 cm (22")	5	15

Type of packaging: Bag

LOCKING SLIDES

- Made of steel
- Nickel-plated finish
- Bearing mechanism
- 3-section slider
- Load capacity per slide set: 30 kg



Bag
2 pieces
Price per bag

Code	Measurement	Inner	Master
PF0248	30 cm (12")	5	15
PF0249	35 cm (14")	5	15
PF0250	40 cm (16")	5	15
PF0251	45 cm (18")	5	15
PF0252	50 cm (20")	5	15
PF0253	55 cm (22")	5	15
PF0254	60 cm (24")	5	15

Type of packaging: Bag

LOCKING SLIDES 2 SECTIONS

- Made of steel
- Nickel-plated finish
- Bearing mechanism
- 2-section slider
- Load capacity per slide set: 15 kg



Bag
2 pieces
Price per bag

Code	Measurement	Inner	Master
PF0259	30 cm (12")	10	15
PF0260	35 cm (14")	10	15
PF0261	40 cm (16")	10	15
PF0262	45 cm (18")	10	15
PF0263	50 cm (20")	10	15
PF0264	55 cm (22")	10	6
PF0265	60 cm (24")	5	15

Type of packaging: Bag

WHITE SLIDER

- Made of steel
- Epoxy paint
- Each slide consists of 2 pieces
- Screws for installation included
- Caliber 0.7 mm
- Load capacity per slide set: 15 kg

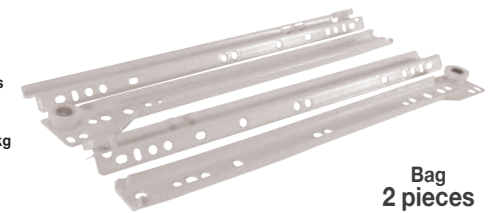

Bag
2 pieces
Price per bag

Code	Measurement	Inner	Master
PF0241	30 cm (12")	10	20
PF0242	35 cm (14")	10	20
PF0243	40 cm (16")	10	20
PF0244	45 cm (18")	10	20
PF0245	50 cm (20")	10	20
PF0246	55 cm (22")	10	20
PF0247	60 cm (24")	10	20

Type of packaging: Bag



DISPLAY AND PROMOTIONAL RACKS

TOOLCRAFT PUMP EXHIBITOR

- MANUFACTURED IN 5/8" mdf with liquid paint finish
- 2 pieces labeled with self-adhesive vinyl cap 60 cm x 25 cm
- 6 removable leveling parts
- Measurements:
 - Height: 160 cm
 - Width: 60 cm
 - Depth: 40 cm

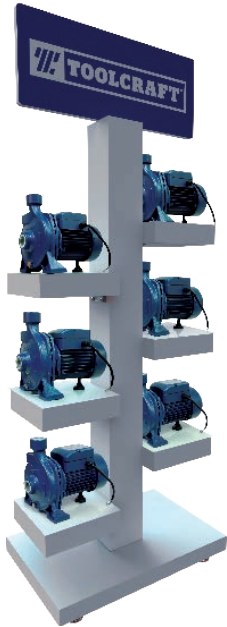

*Does not include product

Code	Capacity
TC5436	6 pumps

TOOLCRAFT SMALL DRILL BITS EXHIBITOR

- Made of 1/2" matt white laminated MDF and band that covers the edges in the same tone.
- Measurements:
 - Height: 17 cm
 - Width: 24 cm
 - Depth: 22 cm



*Does not include product

Code	Capacity
TC5441	12 models of drill bits

TOOLCRAFT BIG DRILL BITS EXHIBITOR

- Made of 1/2" matt white laminated MDF and band that covers the edges in the same tone.
- Measurements:
 - Height: 30 cm
 - Width: 42 cm
 - Depth: 32 cm



*Does not include product

Code	Capacity
TC5437	24 models of drill bits

TOOLCRAFT WHEELBARROW EXHIBITOR

- Structure made of Rectangular Tubular Profile
- Electrostatic paint blue color
- Art: digital print on white vinyl labeled on styrene
- Measurements:
 - Height: 200 cm
 - Width: 82 cm
 - Depth: 70 cm



*Does not include product

Code	Capacity
TC5438	3 wheelbarrows

TOOLCRAFT SMALL SANDPAPER EXHIBITOR

- Main structure in 3 cal wire
- 8 trays made of 8 cal wire with 24 cal sheet border
- Black electrostatic paint application.
- Digitally printed borders
- Measurements:
 - Height: 65 cm
 - Width: 46 cm
 - Depth: 27 cm



*Does not include product

Code	Capacity
TC5439	8 types of sandpaper

TOOLCRAFT SILICONES EXHIBITOR

- Made of wire cal 8 and 11 with black electrostatic paint application.
- Art made in styrene cal 40
- Measurements:
 - Height: 23 cm
 - Width: 23 cm
 - Depth: 10 cm



*Does not include product

Code	Capacity
TC5440	6 silicones

TOOLCRAFT COUNTER EXHIBITOR FOR AEROSOL

- Structure made in wire and sheet with electrostatic painting finish
- 2-piece assemble thermoformed in styrene
- Measurements:
 - Height: 56 cm
 - Width: 30 cm
 - Depth: 28.5 cm



*Does not include product

Code	Capacity
TC5434	20 cans

EXHIBITORS / PROMOTIONALS

TOOLCRAFT FLOOR AEROSOL EXHIBITOR

- Structure of Rectangular Tubular Profile with sheet and wire
- Arts in digital printing labeled on steel sheet.
- Electrostatic paint blue color
- Measurements:
 - Height: 155 cm
 - Width: 50.5 cm
 - Depth: 42.5 cm



*Does not include product

Code	Capacity
TC5435	60 cans

EXHIBITOR YARDEN SINK

- Structure made with RTP for supporting sinks
- Steel sheet
- Black electrostatic paint.
- Digital printing on self-adhesive vinyl labeled on styrene.
- Measurements:

Height: 170 cm
Width: 90 cm
Depth: 70 cm



*Does not include product

Code	Capacity
YD0190	3 types of sinks

TOP FORGE EXHIBITOR HANDLE

- Made of MDF with laminate
- Printed in autoadherible vinyl
- Measurements
 - Height: 52 cm
 - Width: 18 cm
 - Depth: 16 cm

Includes locks:
PF0036, PF0047,
PF0061, PF0066



*Does not include product

Code	On display
PF0280	4 items

Type of packaging: Box

TOP FORGE DOOR RIM LATCH EXHIBITOR

- Made of MDF with laminate
- Printed in autoadherible vinyl
- Measurements
 - Height: 52 cm
 - Width: 18 cm
 - Depth: 16 cm

Includes lock:
PF0190



*Does not include product

Code	On display
PF0281	1 item

YARDEN GENERAL BIG EXHIBITOR

- Made of MDF with matt white laminate
- Thermoformed shelves in 80 gauge PET
- Printed in autoadherible vinyl
- Measurements
 - Height: 160 cm
 - Width: 120 cm
 - Depth: 40 cm



Includes:
Showers: YD0141, YD0142, YD0143, YD0145, YD0149
Mixers: YE0001, YD0001, YD0005, YD0009, YD0012, YD0013

P-trap and Basin: YD0060, YD0061, YD0073, YD0074, YD0075

Drain: YD0128, YD0129, YD0130, YD0132

Installation mode:
-Fixed to wall over 15 cm base (included)

Code	On display
YD0201	20 items

YARDEN GENERAL SMALL EXHIBITOR

- Made of MDF with matt white laminate
- Thermoformed shelves in 80 gauge PET
- Printed in autoadherible vinyl
- Measurements
 - Height: 80 cm
 - Width: 60 cm
 - Depth: 30 cm

Includes:
Showers: YD0141, YD0149
Mixers: YD0001, YD0013
P-trap: YD0073
Drain: YD0130

Installation mode: -Fixed to wall over 15 cm base (included)



Code	On display
YD0202	6 items

YARDEN VALVES EXHIBITOR

- Made of MDF with matt white laminate
- Printed in autoadherible vinyl
- Measurements
 - Height: 80 cm
 - Width: 60 cm
 - Depth: 20 cm

Includes: Ball, boiler, gate and PVC valves
Angular valves
Check foot valve
Water valve

Installation mode:
-Fixed to the wall



Code	On display
YD0203	25 items

TOP FORGE EXHIBITOR DEADBOLT / LEVER HANDLE LOCK

- Made of MDF with laminate
- Printed in autoadherible vinyl
- Measurements
 - Height: 21 cm
 - Width: 34 cm
 - Depth: 8 cm

Includes locks:
PF0003 y PF0021



*Does not include product

Code	On display
PF0282	2 items

**BIG TOOLCRAFT EXHIBITOR
GENERATOR / COMPRESSOR / MOTOR PUMP**

- Made in 3/4 " RTP and metal sheet
- Measurements
Height: 104 cm
Width: 80 cm
Depth: 100 cm



Assemble with TC5533

*Does not include product

Code	On display
TC5536	1 o 2 pieces

**SMALL TOOLCRAFT EXHIBITOR
GENERATOR / COMPRESSOR / MOTOR PUMP**

- Made in 3/4 " RTP and metal sheet
- Measurements
Height: 84 cm
Width: 80 cm
Depth: 68 cm



Assemble with TC5536

*Does not include product

Code	On display
TC5533	2 pieces

**FULGORE PLASTIC PLATES
EXHIBITOR**

- Made of MDF
- Printed in autoadherible vinyl
- Measurements

Height: 70 cm
Width: 40 cm
Depth: 10 cm

- Includes:
line
line
line



Code	On display
FU1682	3 lines

**POWER TOOL TABLE
EXHIBITION**

- Manufactured in metal profile and wood
- Ability to display up to 20 tools
- Includes: Ruedas de hule de uso rudo
- Light box with graphics on both sides
- 6 shelves with height adjustment
- Header with grooved panel for product display
- Top shelves with anti-slip material
- Measurements

Height: 180 cm
Width: 85 cm
Depth: 180 cm



*Does not include product

Code	On display
TC5534	1 - 20 tools

FULGORE BULB EXHIBITOR

- Made of steel sheet
- Printed in autoadherible vinyl
- Includes power cable with plug
- Measurements
Height: 18 cm
Width: 35 cm
Depth: 18 cm



*Does not include product

Code	On display
FU1683	3 items

BOARDERS

- Adhesive border on self-adhesive vinyl paper
- Measurements 25 x 8 cm



PROM5130



PROM5131



PROM5132

HEADBOARD

- Measurements 90 x 25 cm
- Printed on trovicel



Code	Characteristics
PROM5130	FULGORE
PROM5131	TOOLCRAFT
PROM5132	YARDEN

Type of packaging: Box

Code	Characteristics
PROM5147	YARDEN
PROM5145	TOOLCRAFT
PROM5146	WOLFOX
PROM5144	FULGORE

PROMOTIONALS

DOMINO



Code	Characteristics
PROM4592	TOOLCRAFT

CYLINDER



Code	Characteristics
PROM4296	TOOLCRAFT

BALL



Code	Characteristics
PROM3518	TOOLCRAFT

BULB TESTER



Code	Characteristics
PROM4595	TOOLCRAFT

NOTEBOOK



Code	Characteristics
PROM3948	TOOLCRAFT

TOOLCRAFT CATALOG



Code	Characteristics	Price
PROM5206	TOOLCRAFT	\$55.00

POLO T-SHIRT TOOLCRAFT



Code	Size
PROM3931	S
PROM3932	M
PROM3933	L
PROM3934	XL

POLO T-SHIRT TOOLCRAFT



Code	Size
PROM5153	S
PROM5154	M
PROM5155	L
PROM5156	XL

POLO T-SHIRT TOOLCRAFT



Code	Size
PROM5149	S
PROM5150	M
PROM5151	L
PROM5152	XL

PROMOTIONAL T-SHIRT TOOLCRAFT



Code	Size
PROM3919	S
PROM3920	M
PROM3921	L
PROM3922	XL

POLO T-SHIRT FULGORE



Code	Size
PROM5157	S
PROM5158	M
PROM5159	L
PROM5160	XL

T-SHIRT PROMOTIONAL FULGORE



Code	Size
PROM5161	S
PROM5162	M
PROM5163	L
PROM5164	XL



CATALOG 2021



www.toolcraft.mx



FACEBOOK



INSTAGRAM



YOUTUBE



WHATSAPP

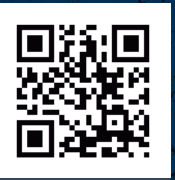

SITIO WEB